

# Product catalog 2019

**Pajacito**®

## TOOLS



---

**The expert knows why**



**Made by professionals for professionalst.**  
since 1923.



**Part 1 Scrapers, trowels, plastering tools, spreaders, notched spreaders** **from page 6**

Burn-off scrapers . Adhesive spreading trowels . Rust removal scraper . Trowels  
Japanese spatulas . Screed trowels . Loam-plaster trowels . Scrapers . Floats  
Stucco trowels . Q3- & Q4 Finishing trowels . Notched blades

**Part 2 Cutting, grinding, scraping, sawing** **from page 48**

Cutters . Mitre boxes . Glass scrapers . Hand-sanders . Saws  
Scrapers . Wallpaper scissors . Scissors . Utility knives . Puller blades

**Part 3 Painting, wallpapering and EIFS tools** **from page 72**

Smoothing rollers . Brushes . Graining tools . Seamrollers . Perforators  
Brush cleaning & keeping . Chalk . Plumb bobs . Sieves . Marking stencils  
Polystyrene rasps & cutters . Telescopic poles . Cleaning tubes . Tool boxes

**Part 4 Tyler, glazier and dry construction tools** **from page 107**

Glass cutters . Grout scrubbers . Sealant & dispensing guns . Putty knives  
Mixing paddle . Glass pane lifters . Spatulas . Pliers

**Part 5 Floor laying tools** **from page 120**

Scribing tools . Floor spreaders . Design flooring tools . Aerator rollers  
Hand grooving tools . Large spreaders . Knee pads . Flooring rollers  
Straight edges . Nail shoes . Tackers . Carpet clamps . Carpet knives  
Hand trucks . Quarter-moon knives . Squares

**Part 6 Health and safety, workshop & construction site requirements** **from page 144**

Health and safety . Construction site keys . Brooms . Roofer tools . First-aid boxes  
Scaffolding . Hammers . Gloves . Lamps . Chisel . Measuring devices  
Screwdriver sets . Dust proof door . Spirit levels . Pliers

**Part 7 Machines and accessories laser-technology, measuring instruments** **from page 160**

Humidity-, thickness- and surface-meters . Hot air technology . Laser-technology  
Mixers . Grinding- and cleaning accessories . Sanding machines . Tripods

**Terms of Delivery and Payment Index** **from page 180**

1

2

3

4

5

6

7

8



**Display walls:**

The appropriate display for every purpose.

# Display walls

**It is only when you maintain and foster customer contacts that you are able to react promptly and flexibly to the requirements of the trade and industry. Good service and professional field staff are therefore of particular importance to Pajarito.**

## Well prepared with Pajarito

Pajarito manufactures for professionals. That is why our ranges are only sold through specialised traders. We offer extensive advice to customers and install Pajarito display walls to meet their specific requirements. The installation and inscription and provided free of charge. Our field staff team member responsible equips and maintains the display walls at regular intervals. The specialist trade and commercial customers therefore have competent contact persons available for consultation at all times. So in terms of service, we are also 100 % professional.

## Local product demonstrations

Irrespective of whether you need an individual consultation or a training or would simply like to have some specific products demonstrated, just give us a call and make an appointment; at your wholesaler's or on your own premises.



**Our fair booth:**  
Successfully represented internationally

## Represented worldwide

**Pajarito considers itself an international company. This is because quality is very much welcomed throughout the world.**

### **Presentable quality Everywhere in the world**

Pajarito is regularly represented at the following international fairs and exhibitions with its own booth:  
 "BAU", Munich  
 "DOMOTEX", Hanover  
 "Farbe – Ausbau & Fassaden", Cologne/Munich

Moreover, you will find us at about 250 customer-dedicated "house fairs" each year.

### **Short delivery periods inclusive**

Pajarito quality is in demand internationally. That is why we are also professional in the export business. Whenever you order something from us, it does not really matter where to. Whether it is Bamberg or Bangkok, Peine or Paris, Rome or Rosenheim: we supply worldwide – quickly, competently and reliably. We regard short delivery periods as a matter of honour.



# Do you know Pajarito?

**To manufacture products that we are convinced about ourselves, that meet the most exacting standards and are in the best possible quality: that is what it is all about at Pajarito.**

## **Production in Germany**

The location in Germany is absolutely essential for us. Here in Mettmann, in North Rhine-Westphalia, we find the ideal preconditions for our quality products: motivated staff with a close eye on details and real experts with the ideas that have made Pajarito to what it is today. All our employees work outstandingly well here every day: in a nutshell, German workmanship!

## **From professionals for professionals**

Our products have been specifically developed for professionals and provide superior solutions for the building and handicraft sectors and are solely marketed through wholesalers. The members of our field sales force fill the Pajarito display walls with a partial range and assume the task of automatically refilling and optimising the portfolio. Thus, more time remains for consultation and sales.

## **Tailored to your needs**

Exceptional assignments necessitate exceptional tools. That is the reason why the experts at our “think tank” develop tailored special manufacturers to meet specific customer requirements – of course, in certified, top quality. Such innovative tools mean that every movement of the hand is fast and accurate – this conserves resources and saves money. Just give us a call: we would be pleased to help!

## **Personal contact**

Our field sales force is an essential pillar of our operations. After all, it is only in personal talks that optimal results can be achieved. That is why we regularly offer product demonstrations and trainings – either locally, at the wholesaler’s or in your company. This service is well worthwhile since our field staff force has been working exclusively with Pajarito products for years and is therefore very well acquainted with them.

You, as a customer, understand your business and we at Pajarito have the right ideas whenever tools are concerned. This partnership is the foundation for successful cooperation.



### **The original logo**

The company was founded in 1923 and was initially an overseas exporter selling high quality consumer merchandise to Latin American countries. The trademark and the name Pajarito – Spanish for “small bird” – stem from this era. Until 1952, the heraldic bird was an integral part of the logo. Even today it adorns many of our traditional products.

# Your contact persons in Germany:

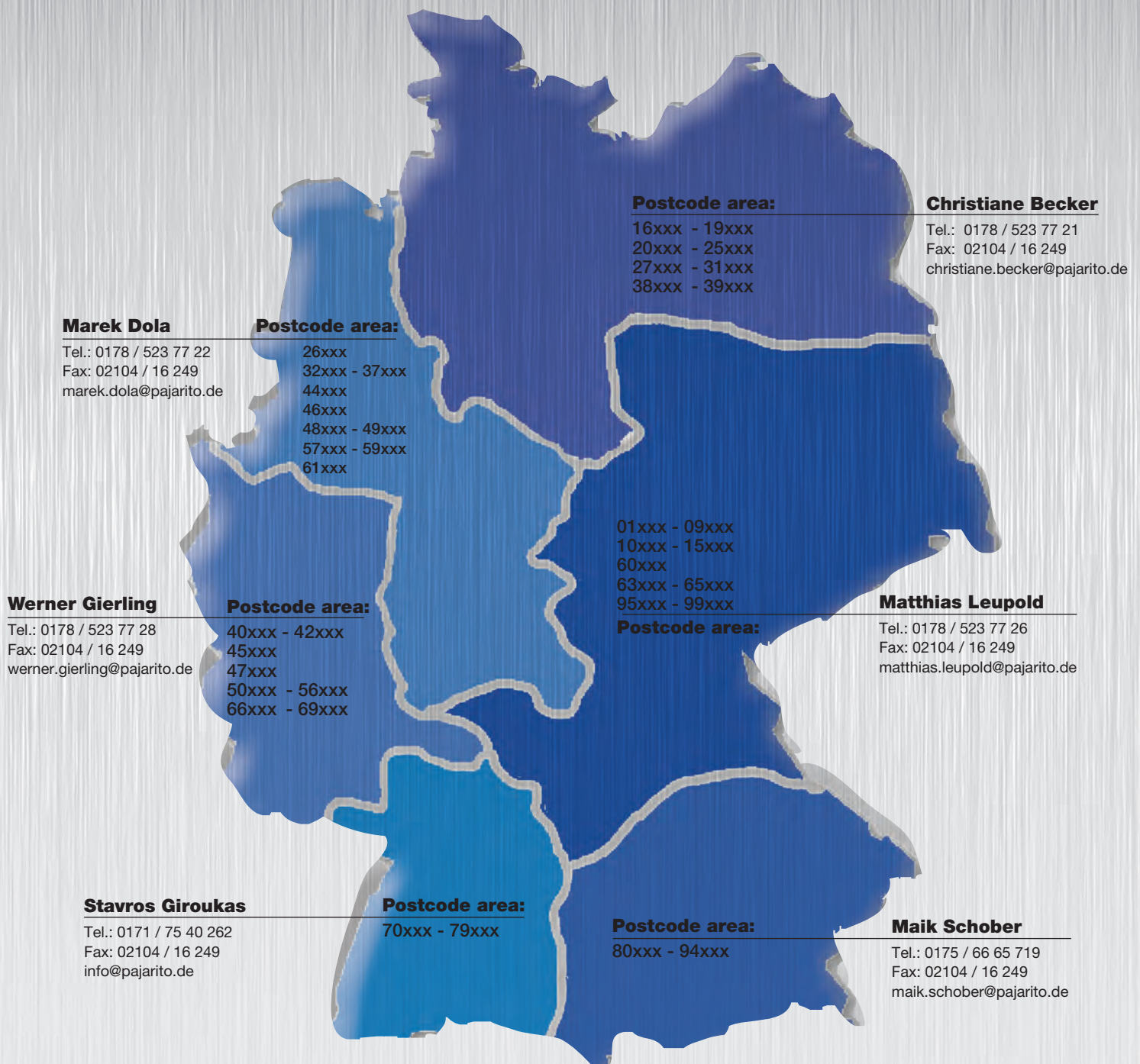

## Field Sales Management Germany:

### Willi Eulenbach

Tel.: +49 (0) 178 / 523 77 23  
Fax: +49 (0) 2104 / 16 249  
willi.eulenbach@pajarito.de

## Contacts in Europe:

Benelux, Great Britain,  
Portugal, Scandinavia, Spain, France

### Marten Neleman

Tel.: +49 (0) 178 / 523 77 24  
Fax: +49 (0) 2104 / 16 249  
marten.neleman@pajarito.de

## Sales / Order acceptance:

### Marcus Behrens

Leitung Verkauf Innendienst  
Tel.: +49 (0) 2104 / 3000-14  
Fax: +49 (0) 2104 / 16 249  
marcus.behrens@pajarito.de

### Christel Engmann

Tel.: +49 (0) 2104 / 3000-16  
Fax: +49 (0) 2104 / 16 249  
christel.engmann@pajarito.de

### Hella Eulenbach

Tel.: +49 (0) 2104 / 3000-25  
Fax: +49 (0) 2104 / 16 249  
hella.eulenbach@pajarito.de

## Austria

### Maik Schober

Tel.: +49 (0) 175 / 66 65 719  
Fax: +49 (0) 2104 / 16 249  
maik.schober@pajarito.de

## Export:

### Gudrun Mischo

Tel.: +49 (0) 2104 / 3000-15  
Fax: +49 (0) 2104 / 16 249  
gudrun.mischo@pajarito.de

**Tel.:** +49 2104/3000-0 **Fax:** +49 2104/16249 **Internet:** www.pajarito.de



1



## To good partnership

**Contact and trust, consultancy and sales, training, service and field sales staff with many years of customer relations: Welcome to the world of Pajarito.**

Close contacts to our customers are important to us. After all, it is only in a personal exchange that customer requirements can be appreciated and individual product portfolios developed. Our field sales force lives this partnership. That is what they have been trained for. They are very well acquainted with our products, can provide you with an answer on all

technical issues and support your company with product demonstrations, punctual deliveries and thorough training sessions. Just simply give us a call!

**Tools from Pajarito:  
The foundation for successful cooperation.**

# Scrapers, trowels, plastering tools, spreaders & notched spreaders

1

Highlight-product: finishing trowel **PAJAQUICK**  
for precision plastering



Blade made from 0.5 mm  
special stainless steel

Ergonomical plastic  
handle



Wooden handle  
also available



Best of Pajarito! For plastered Q3 und Q4 surfaces with the best result: the PAJAQUICK finishing trowel meets the latest demands – and has advantages for your day to day work! The optimised design, the lightweight plastic support and the blade made from a special stainless steel has rounded edges to enable an almost ridge-free finish on walls and ceilings are most convincing. The result: always perfect!  
Made in Germany – Made by Pajarito.

Finishing trowel **PAJAQUICK** on page 31.



Scrapers from page 8



Spreaders from page 11



Japanese spatulas on page 13

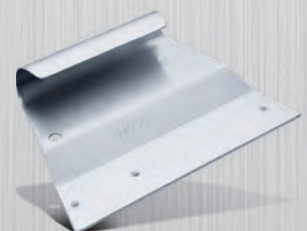

Coloquick-spreader on page 42

# Going smoothly

Made in Germany  
Made by Pajarito



### Stripping scraper

Hardened, flexible, dry-fined steel blade, gently curved, waxed beech handle, riveted full-length tang.

| Item No | EAN*   | Width  | Qty |
|---------|--------|--------|-----|
| 2/2     | 102021 | 20 mm  | 12  |
| 2/3     | 102038 | 30 mm  | 12  |
| 2/4     | 102045 | 40 mm  | 12  |
| 2/5     | 102052 | 50 mm  | 12  |
| 2/6     | 102069 | 60 mm  | 12  |
| 2/7     | 102076 | 70 mm  | 12  |
| 2/8     | 102083 | 80 mm  | 12  |
| 2/10    | 102106 | 100 mm | 12  |
| 2/12    | 102113 | 120 mm | 12  |

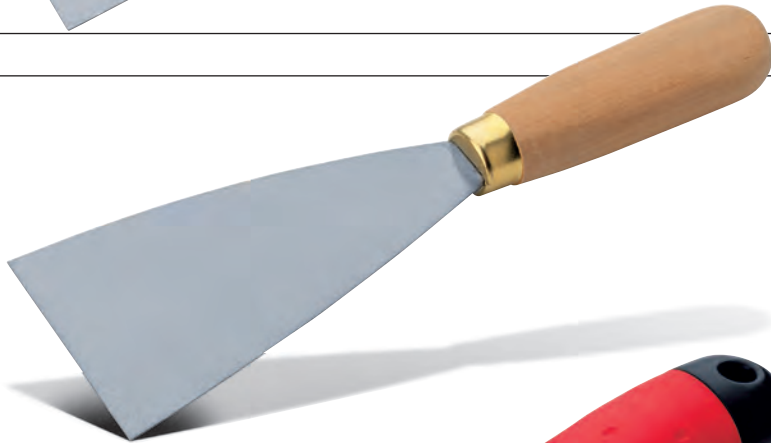

### Stripping scraper

Hardened, flexible steel blade, oval wooden handle, riveted full-length tang.

| Item No | EAN*   | Width  | Qty |
|---------|--------|--------|-----|
| 8002/2  | 800019 | 20 mm  | 12  |
| 8002/3  | 633563 | 30 mm  | 12  |
| 8002/4  | 800026 | 40 mm  | 12  |
| 8002/5  | 633365 | 50 mm  | 12  |
| 8002/6  | 800033 | 60 mm  | 12  |
| 8002/8  | 800040 | 80 mm  | 12  |
| 8002/10 | 800057 | 100 mm | 12  |
| 8002/12 | 800064 | 120 mm | 12  |

Made in Germany  
Made by Pajarito



### Stripping scraper

Hardened, flexible, dry-fined steel blade, ergonomically shaped plastic handle.

| Item No | EAN*   | Width  | Qty |
|---------|--------|--------|-----|
| 5002/3  | 100065 | 30 mm  | 12  |
| 5002/4  | 100072 | 40 mm  | 12  |
| 5002/6  | 100164 | 60 mm  | 12  |
| 5002/8  | 100195 | 80 mm  | 12  |
| 5002/10 | 100201 | 100 mm | 12  |
| 5002/12 | 100270 | 120 mm | 12  |

Made in Germany  
Made by Pajarito



### Stripping scraper, stainless

Hardened, flexible, highly-polished stainless steel blade, moulded-on plastic handle.

| Item No | EAN*   | Width  | Qty |
|---------|--------|--------|-----|
| 2PR/4   | 520047 | 40 mm  | 12  |
| 2PR/5   | 520054 | 50 mm  | 12  |
| 2PR/6   | 520061 | 60 mm  | 12  |
| 2PR/8   | 520085 | 80 mm  | 12  |
| 2PR/10  | 520108 | 100 mm | 12  |
| 2PR/12  | 520122 | 120 mm | 12  |

Made in Germany  
Made by Pajarito



### Stripping scraper, stainless

Hardened, flexible, dry-fined stainless steel blade, riveted two-piece exotic-hardwood handle.

| Item No | EAN*   | Width  | Qty |
|---------|--------|--------|-----|
| 2AR/3   | 102281 | 30 mm  | 12  |
| 2AR/4   | 102298 | 40 mm  | 12  |
| 2AR/6   | 102304 | 60 mm  | 12  |
| 2AR/8   | 102311 | 80 mm  | 12  |
| 2AR/10  | 102328 | 100 mm | 12  |

Please note: image scale of products may vary.

**Offset stripping knife**

Forged offset, hardened, flexible steel blade, dry-fined wad half flat tang, exotic-hardwood handle.

| Item No | EAN*   | Width  | Qty |
|---------|--------|--------|-----|
| 3/1     | 103011 | 10 mm  | 12  |
| 3/2     | 103028 | 20 mm  | 12  |
| 3/3     | 103035 | 30 mm  | 12  |
| 3/4     | 103042 | 40 mm  | 12  |
| 3/5     | 103059 | 50 mm  | 12  |
| 3/6     | 103066 | 60 mm  | 12  |
| 3/7     | 103073 | 70 mm  | 12  |
| 3/8     | 103080 | 80 mm  | 12  |
| 3/9     | 103097 | 90 mm  | 12  |
| 3/10    | 103103 | 100 mm | 12  |
| 3/11    | 103110 | 110 mm | 12  |
| 3/12    | 103127 | 120 mm | 12  |
| 3/14    | 103141 | 140 mm | 12  |
| 3/16    | 103165 | 160 mm | 12  |

III Made in Germany  
Made by Pajarito

**Offset stripping knife**

Forged offset, hardened, flexible dry-fined steel blade, resin embedded full round tang, exotic-hardwood handle with brass ferrule.

| Item No | EAN*   | Width  | Qty |
|---------|--------|--------|-----|
| 4/3     | 504030 | 30 mm  | 12  |
| 4/4     | 504047 | 40 mm  | 12  |
| 4/5     | 504054 | 50 mm  | 12  |
| 4/6     | 504061 | 60 mm  | 12  |
| 4/8     | 504085 | 80 mm  | 12  |
| 4/10    | 504108 | 100 mm | 12  |

III Made in Germany  
Made by Pajarito

**Beryllium stripping knife**

Hardened, flexible, dry-fined beryllium blade for spark-free work, half flat tang, exotic-hardwood handle with two brass rivets.

| Item No | EAN*   | Width | Qty |
|---------|--------|-------|-----|
| 200/4   | 120049 | 40 mm | 12  |
| 200/6   | 120063 | 60 mm | 12  |
| 200/8   | 120087 | 80 mm | 12  |

III Made in Germany  
Made by Pajarito

**Brass scraper**

Brass blade, oval wooden handle, securely knocked blade, finely grinded, for spark-free work.

| Item No | EAN*   | Width | Qty |
|---------|--------|-------|-----|
| 8200/4  | 014966 | 40mm  | 12  |
| 8200/6  | 014973 | 60mm  | 12  |
| 8200/8  | 014980 | 80mm  | 12  |
| 8200/10 | 014997 | 100mm | 12  |

**Rust removal scraper**

Hardened, shorter, stiffer blade, edge bevelled on one side, gently curved, waxed beech handle, riveted full-length tang.

| Item No | EAN*   | Width  | Qty |
|---------|--------|--------|-----|
| 7/5     | 107057 | 50 mm  | 12  |
| 7/7     | 107071 | 70 mm  | 12  |
| 7/10    | 107101 | 100 mm | 12  |

III Made in Germany  
Made by Pajarito

**Rust removal scraper**

Hardened, shorter, stiffer blade, edge bevelled on one side, wooden handle, standard issue.

| Item No | EAN*   | Width  | Qty |
|---------|--------|--------|-----|
| 8007/5  | 694601 | 50 mm  | 12  |
| 8007/7  | 694700 | 70 mm  | 12  |
| 8007/10 | 694809 | 100 mm | 12  |



Made in Germany  
Made by Pajarito



**Rust and paint removal scraper**

Hardened, short, stiff steel blade, bevelled edge on one side, 200 mm long waxed, round beech handle.

| Item No | EAN*   | Width  | Qty |
|---------|--------|--------|-----|
| 7L/5    | 107255 | 50 mm  | 12  |
| 7L/7    | 107279 | 70 mm  | 12  |
| 7L/10   | 107309 | 100 mm | 12  |

**Rust and paint removal scraper**

Hardened, long, stiff steel blade, bevelled edge on one side, wooden handle.

| Item No | EAN*   | Width | Qty |
|---------|--------|-------|-----|
| 8007L/3 | 630487 | 30 mm | 12  |
| 8007L/5 | 630500 | 50 mm | 12  |
| 8007L/7 | 630586 | 70 mm | 12  |

Made in Germany  
Made by Pajarito



Art.-Nr. 9A Art.-Nr. 9C Art.-Nr. 9D Art.-Nr. 9E Art.-Nr. 9F

**Paint removal scraper**

Stem made from 8 mm steel bar, 1 mm thick hardened and polished steel blade riveted on, bevelled edge on one side, wooden handle, overall length 310 mm. Model 9F comes with bend-up blade.

| Item No | EAN*   | Width | Qty |
|---------|--------|-------|-----|
| 9A      | 100096 | 20 mm | 12  |
| 9C      | 100119 | 30 mm | 12  |
| 9D      | 100126 | 50 mm | 12  |
| 9E      | 100133 | 70 mm | 12  |
| 9F      | 100140 | 50 mm | 12  |

Made in Germany  
Made by Pajarito



**Chisel scraper (no illustration)**

Hardened, stiff steel blade, bevelled edge on one side, half flat tang, exotic hardwood handle with two brass rivets.

| Item No | EAN*   | Width  | Qty |
|---------|--------|--------|-----|
| 384/3   | 138433 | 30 mm  | 12  |
| 384/4   | 138440 | 40 mm  | 12  |
| 384/6   | 138464 | 60 mm  | 12  |
| 384/8   | 138488 | 80 mm  | 12  |
| 384/10  | 138402 | 100 mm | 12  |

**Chisel scraper, stainless**

As Item No 384, but stainless steel.

|         |        |        |    |
|---------|--------|--------|----|
| 384R/3  | 138426 | 30 mm  | 12 |
| 384R/4  | 138457 | 40 mm  | 12 |
| 384R/6  | 138471 | 60 mm  | 12 |
| 384R/8  | 138495 | 80 mm  | 12 |
| 384R/10 | 138389 | 100 mm | 12 |



**Multifunction scraper, stainless**

Hardened 1,8 mm thick stainless steel blade for various scraping tasks. Forged from one piece with extra thick strike plate at the upper end of the ergonomical multi-component handle.

| Item No | EAN*   | Width | Qty |
|---------|--------|-------|-----|
| 387     | 022763 | 75 mm | 12  |

Made in Germany  
Made by Pajarito



**Square taping knife**

Hardened and polished 0,6 mm thick spring steel, wooden handle.

| Item No | EAN*   | Width        | Qty |
|---------|--------|--------------|-----|
| 60/12   | 160120 | 120 x 120 mm | 6   |
| 60/16   | 160168 | 160 x 120 mm | 6   |
| 60/20   | 160205 | 200 x 120 mm | 6   |

Please note: image scale of products may vary.

**Utility taping knife**

Plastic handle, bolted-on rectangular polished spring band steel blade.

| Item No            | EAN*   | Width  | Qty |
|--------------------|--------|--------|-----|
| 648A               | 505167 | 100 mm | 12  |
| <b>Spare blade</b> |        |        |     |
| 648A/E             | 505204 | 100 mm | 12  |

III Made in Germany  
Made by Pajarito

**Plasterer putty knife (no illustration)**

Hardened, polished spring band steel blade, 0.7 mm thick, bevelled edge on one side, riveted-on forged full-metal tang, wooden handle.

| Item No | EAN*   | Blade-size   | Qty |
|---------|--------|--------------|-----|
| 126G/6  | 112662 | 60 x 90 mm   | 10  |
| 126G/8  | 212683 | 80 x 90 mm   | 10  |
| 126G/10 | 112617 | 100 x 100 mm | 10  |
| 126G/12 | 112624 | 120 x 100 mm | 10  |
| 126G/15 | 112655 | 150 x 100 mm | 10  |

**Plasterer putty knife, stainless**

As Item No 126G, but with stainless steel blade.

|           |        |              |    |
|-----------|--------|--------------|----|
| 126G/R/6  | 112709 | 60 x 90 mm   | 10 |
| 126G/R/8  | 112723 | 80 x 90 mm   | 10 |
| 126G/R/10 | 112747 | 100 x 100 mm | 10 |
| 126G/R/12 | 112754 | 120 x 100 mm | 10 |
| 126G/R/15 | 112761 | 150 x 100 mm | 10 |

III Made in Germany  
Made by Pajarito



# Spreaders

**Spreader, stainless**

Hardened, polished spring band steel, 0.4 mm thick, straight edges, flared plywood handle, visible blade height 42 mm. Handle is predrilled to accept mounting socket (Item No 657 on page 13).

| Item No | EAN*   | Width  | Qty |
|---------|--------|--------|-----|
| 655R/25 | 165545 | 250 mm | 10  |
| 655R/40 | 165552 | 400 mm | 10  |
| 655R/50 | 165569 | 500 mm | 10  |
| 655R/60 | 165576 | 600 mm | 6   |

**Spreader (no illustration)**

As Item No 655R, but not stainless, visible blade height 52 mm.

|        |        |        |    |
|--------|--------|--------|----|
| 655/25 | 165507 | 250 mm | 10 |
| 655/40 | 165514 | 400 mm | 10 |
| 655/50 | 165521 | 500 mm | 10 |
| 655/60 | 165538 | 600 mm | 6  |

**Spreader, stainless**

As Item No 655R, but standard version.

|          |        |        |    |
|----------|--------|--------|----|
| 8655R/25 | 105640 | 250 mm | 10 |
| 8655R/40 | 105657 | 400 mm | 10 |
| 8655R/60 | 105343 | 600 mm | 6  |

III Made in Germany  
Made by Pajarito



III Made in Germany  
Made by Pajarito





Made in Germany  
Made by Pajarito



**Spreader, stainless**

Hardened, polished stainless spring band steel, 0.5 mm thick, straight edges, flared plywood handle, visible blade height 45 mm. Handle is predrilled to accept mounting socket (Item No 657 on page 13).

| Item No        | EAN*   | Width  | Qty |
|----------------|--------|--------|-----|
| <b>656R/25</b> | 165644 | 250 mm | 10  |
| <b>656R/40</b> | 165651 | 400 mm | 10  |
| <b>656R/50</b> | 165668 | 500 mm | 10  |
| <b>656R/60</b> | 165675 | 600 mm | 6   |

**Spreader, stainless**

As Item No 656R, but standard version.

| Item No         | EAN*   | Width  | Qty |
|-----------------|--------|--------|-----|
| <b>8656R/25</b> | 660866 | 250 mm | 10  |
| <b>8656R/40</b> | 662006 | 400 mm | 10  |
| <b>8656R/60</b> | 662068 | 600 mm | 6   |

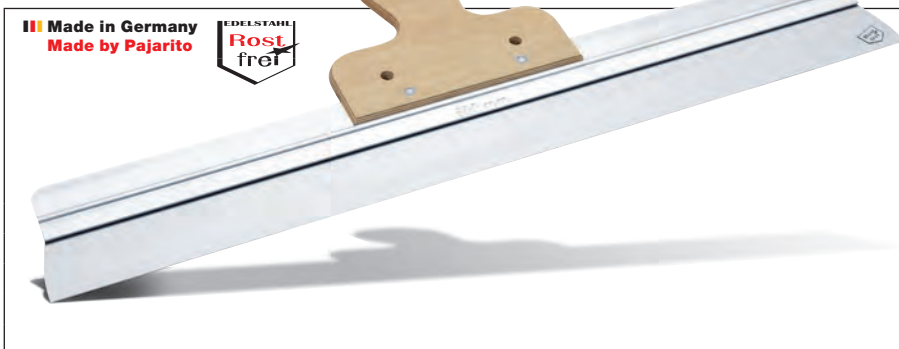

Made in Germany  
Made by Pajarito



**Aluminium spreader, stainless**

Hardened, polished spring band steel, 0.4 mm thick, machine fitted aluminium profile, curved plywood handle, visible blade height 40 mm. Handle is predrilled to accept mounting socket (Item No 657 on page 13).

| Item No         | EAN*   | Width  | Qty |
|-----------------|--------|--------|-----|
| <b>8555R/25</b> | 692706 | 250 mm | 10  |
| <b>8555R/40</b> | 692805 | 400 mm | 10  |
| <b>8555R/50</b> | 692904 | 500 mm | 10  |
| <b>8555R/60</b> | 693000 | 600 mm | 10  |



Made in Germany  
Made by Pajarito



**Soft-grip spreader, stainless**

Hardened, polished spring band steel, 0.4 mm thick, machine fitted aluminium profile, soft-grip plastic handle, visible blade height 45 mm.

| Item No         | EAN*   | Width  | Qty |
|-----------------|--------|--------|-----|
| <b>5655R/17</b> | 009702 | 170 mm | 10  |
| <b>5655R/22</b> | 009719 | 220 mm | 10  |
| <b>5655R/28</b> | 009726 | 285 mm | 10  |
| <b>5655R/38</b> | 009733 | 380 mm | 10  |
| <b>5655R/48</b> | 009740 | 480 mm | 10  |
| <b>5655R/57</b> | 009757 | 570 mm | 10  |



Made in Germany  
Made by Pajarito



**Spreader, stainless**

As Item No 5655R, but with American style soft-grip handle.

| Item No          | EAN*   | Width  | Qty |
|------------------|--------|--------|-----|
| <b>5660RA/17</b> | 009764 | 170 mm | 10  |
| <b>5660RA/22</b> | 009771 | 220 mm | 10  |
| <b>5660RA/28</b> | 009788 | 285 mm | 10  |
| <b>5660RA/38</b> | 009795 | 380 mm | 10  |
| <b>5660RA/48</b> | 009801 | 480 mm | 10  |
| <b>5660RA/57</b> | 009818 | 570 mm | 10  |

**Spreader, stainless (no illustration)**

As Item No 5660RA, but rounded edges.

| Item No           | EAN*   | Width  | Qty |
|-------------------|--------|--------|-----|
| <b>5660RRA/17</b> | 016205 | 170 mm | 10  |
| <b>5660RRA/22</b> | 016212 | 220 mm | 10  |
| <b>5660RRA/28</b> | 016229 | 285 mm | 10  |
| <b>5660RRA/38</b> | 016236 | 380 mm | 10  |
| <b>5660RRA/48</b> | 016243 | 480 mm | 10  |
| <b>5660RRA/57</b> | 016250 | 570 mm | 10  |

Please note: image scale of products may vary.

| Wooden knob, angled  |        |            |     |
|--|--------|------------|-----|
| Beechwood, 40 mm dia., complete with 2 screws to attach to spreader. |        |            |     |
| Item No  | EAN*   | Dimensions | Qty |
| 5655K  | 506744 | 70 mm      | 6   |

III Made in Germany  
Made by Pajarito



| Socket  |        |            |     |
|---|--------|------------|-----|
| Made from a light alloy, complete with screws and wingnuts. |        |            |     |
| Item No   | EAN*   | Dimensions | Qty |
| 657   | 506577 |            | 6   |

| Japanese spatulas, set, stainless   |        |            |     |
|---|--------|------------|-----|
| Hardened, polished spring band stainless steel, 0.3 mm thick, machine fitted aluminium profile spine, absolutely solvent resistant, each set packaged in a blue plastic pouch, set consists of 1 each width: 50, 80, 105, 120 mm. |        |            |     |
| Item No   | EAN*   | Dimensions | Qty |
| 65R   | 165033 |            | 25  |

| Japanese spatula, single, stainless                                   |        |              |     |
|---|--------|--------------|-----|
| As Item No 65R, but individually packed, 12 pcs per size in a carton. |        |              |     |
| Item No   | EAN*   | Dimensions   | Qty |
| 66R/5   | 166344 | 50 x 90 mm   | 12  |
| 66R/8   | 166313 | 80 x 120 mm  | 12  |
| 66R/10,5  | 166320 | 105 x 120 mm | 12  |
| 66R/12  | 166337 | 120 x 120 mm | 12  |

| Japanese spatulas, set (no illustration)   |        |            |     |
|--|--------|------------|-----|
| As Item No 65R, but hardened, polished spring band steel, each set packaged in a red plastic pouch, set consists of 1 each width: 50, 80, 105, 120 mm. |        |            |     |
| Item No  | EAN*   | Dimensions | Qty |
| 65   | 165002 |            | 25  |

| Japanese spatula, single (no illustration)                           |        |              |     |
|--|--------|--------------|-----|
| As Item No 65, but individually packed, 12 pcs per size in a carton. |        |              |     |
| Item No  | EAN*   | Dimensions   | Qty |
| 66/5   | 166054 | 50 x 90 mm   | 12  |
| 66/8   | 166085 | 80 x 120 mm  | 12  |
| 66/10,5  | 166153 | 105 x 120 mm | 12  |
| 66/12  | 166122 | 120 x 120 mm | 12  |
| 66/14  | 166146 | 140 x 120 mm | 12  |
| 66/16  | 166160 | 160 x 120 mm | 12  |

| Japanese spatula, single, stainless, standard version (no illustration) |        |            |     |
|---|--------|------------|-----|
| As Item No 65R, but each set in a polythene bag.                        |        |            |     |
| Item No   | EAN*   | Dimensions | Qty |
| 8165R   | 667117 |            | 25  |

| Japanese spatula, set, standard version (no illustration) |        |            |     |
|---|--------|------------|-----|
| As Item No 65, but each set in a polythene bag.           |        |            |     |
| Item No   | EAN*   | Dimensions | Qty |
| 8165  | 667018 |            | 25  |

| Japanese spatula, single, standard version (no illustration)         |        |              |     |
|--|--------|--------------|-----|
| As Item No 65, but individually packed, 12 pcs per size in a carton. |        |              |     |
| Item No  | EAN*   | Dimensions   | Qty |
| 8166/5   | 667216 | 50 x 90 mm   | 12  |
| 8166/8   | 667315 | 80 x 120 mm  | 12  |
| 8166/10,5  | 667414 | 105 x 120 mm | 12  |
| 8166/12  | 667513 | 120 x 120 mm | 12  |

# Japanese Spatulas

III Made in Germany  
Made by Pajarito





**Japanese spatulas, stainless, plastic spine, set**

Hardened, polished stainless spring band steel, 0.3 mm thick, plastic spine, each set packaged in a transparent plastic pouch, set consists of 1 each width: 50, 80, 105, 120 mm.

| Item No | EAN*   | Qty |
|---------|--------|-----|
| 8065R   | 505150 | 12  |

**Japanese spatulas, plastic spine, set (no illustration)**

As Item No 8065R, but not stainless.

|      |        |    |
|------|--------|----|
| 8065 | 706601 | 12 |
|------|--------|----|

**Japanese spatula, plastic spine, single (no illustration)**

As Item No 8065, but individually packed, 12 pcs per size in a carton.

| Item No   | EAN*   | Dimensions   | Qty |
|-----------|--------|--------------|-----|
| 8066/5    | 706625 | 50 x 90 mm   | 12  |
| 8066/8    | 706632 | 80 x 120 mm  | 12  |
| 8066/10,5 | 706649 | 105 x 120 mm | 12  |
| 8066/12   | 706656 | 120 x 120 mm | 12  |

Made in Germany  
Made by Pajarito



**Plastic spatulas, set**

Plastic, 1mm thick, qualified solvent resistance, set package consists of 1 each width: 50, 80, 105, 120 mm.

| Item No | EAN*   | Qty |
|---------|--------|-----|
| 67      | 167006 | 12  |



**Plastic spatulas, set**

Plastic, solvent resistant, standard version, set package consists of 1 each width: 50, 80, 105, 120 mm.

| Item No | EAN*   | Qty |
|---------|--------|-----|
| 8067    | 706700 | 12  |

Please note: image scale of products may vary.

# Proper job!

**Own tool design and construction, high class assortment, short delivery times, competent advice. Success is an upward curve with Pajarito as your partner.**  
**Pajarito: Brand, not bulk. Since 1923.**

| Plastic spatulas, set  |        |             |     |
|--|--------|-------------|-----|
| Plastic, solvent resistant, tapered, set package consists of 1 each width: 100, 130, 150 mm. |        |             |     |
| Item No  | EAN*   |             | Qty |
| 067  | 567004 |             | 12  |
| Plastic spatula  |        |             |     |
| As Item No 067, but individually packed, 12 pcs per size in a carton.                        |        |             |     |
| Item No  | EAN*   | Width       | Qty |
| 067L/A   | 567028 | 150 x 90 mm | 12  |
| 067L/B   | 567035 | 130 x 80 mm | 12  |
| 067L/C   | 567042 | 100 x 70 mm | 12  |



| Bodywork spatula                                      |        |             |     |
|---|--------|-------------|-----|
| Elastic, transparent plastic, acid and lye resistant. |        |             |     |
| Item No   | EAN*   | Dimensions  | Qty |
| 8035  | 000044 | 115 x 85 mm | 12  |



| Plastic spatula   |        |        |     |
|---|--------|--------|-----|
| Trapezoid shaped, nitro resistant, coloured plastic, beaded ridge back. |        |        |     |
| Item No   | EAN*   | Width  | Qty |
| 8034  | 101222 | 140 mm | 12  |



| Rubber spatula                    |        |             |     |
|-----------------------------------|--------|-------------|-----|
| Semi hard rubber, 4 mm thickness. |        |             |     |
| Item No                           | EAN*   | Dimensions  | Qty |
| 89A                               | 508908 | 80 x 120 mm | 12  |
| 89B                               | 508915 | 65 x 100 mm | 12  |
| 89C                               | 508922 | 50 x 75 mm  | 12  |

**Made in Germany**  
**Made by Pajarito**



| Rubber spatula                  |        |             |     |
|---------------------------------|--------|-------------|-----|
| As Item No 89, but soft rubber. |        |             |     |
| Item No                         | EAN*   | Dimensions  | Qty |
| 89W/A                           | 508939 | 80 x 120 mm | 12  |
| 89W/B                           | 508946 | 65 x 100 mm | 12  |
| 89W/C                           | 508953 | 50 x 75 mm  | 12  |

**Made in Germany**  
**Made by Pajarito**



Made in Germany  
Made by Pajarito



**Rapid spreader, stainless**

Hardened, polished stainless spring band steel blade, slightly curved at the working edge, 100 mm visible blade height, adjustable backing plate, 35 mm wide waxed wood handle.

| Item No | EAN*   | Width  | Qty |
|---------|--------|--------|-----|
| 446R/12 | 144748 | 120 mm | 12  |
| 446R/15 | 144656 | 150 mm | 12  |
| 446R/20 | 144663 | 200 mm | 12  |
| 446R/27 | 144670 | 270 mm | 6   |
| 446R/35 | 144731 | 350 mm | 6   |

**Rapid spreader (no illustration)**

As Item No 446R, but not stainless.

|        |        |        |    |
|--------|--------|--------|----|
| 446/12 | 144601 | 120 mm | 12 |
| 446/15 | 144618 | 150 mm | 12 |
| 446/20 | 144625 | 200 mm | 12 |
| 446/27 | 144632 | 270 mm | 6  |
| 446/35 | 144649 | 350 mm | 6  |

**Rapid spreader, stainless, standard version**

As Item No 446R. Standard version.

|          |        |        |    |
|----------|--------|--------|----|
| 8446R/15 | 105619 | 150 mm | 10 |
| 8446R/20 | 105626 | 200 mm | 10 |
| 8446R/27 | 105633 | 270 mm | 10 |

**Rapid spreader, standard version (no illustration)**

As Item No 446. Standard version.

|         |        |        |    |
|---------|--------|--------|----|
| 8446/15 | 001645 | 150 mm | 10 |
| 8446/20 | 001652 | 200 mm | 10 |
| 8446/27 | 001669 | 270 mm | 10 |

Made in Germany  
Made by Pajarito



**Rapid spreader, stainless**

As Item No 446R, but with rounded edges, ideal application tool for laquering, waxing, oiling of parquet flooring.

| Item No | EAN*   | Width  | Qty |
|---------|--------|--------|-----|
| 447R/20 | 025191 | 200 mm | 12  |
| 447R/27 | 105442 | 270 mm | 6   |

Made in Germany  
Made by Pajarito



Pajarito  
GERMANY  
1864 / 220cm

...der Fachmann  
weiß warum  
GERMANY  
33-222-569-0506  
INTERNATIONAL  
1515B-459490

Made in Germany  
Made by Pajarito

**Door spreader**

Hardened, polished spring band steel blade, 105 mm visible blade height, 40 mm wide waxed wood handle.

| Item No | EAN*   | Width  | Qty |
|---------|--------|--------|-----|
| 64/16   | 164166 | 160 mm | 12  |
| 64/20   | 164203 | 200 mm | 12  |
| 64/30   | 164302 | 300 mm | 6   |
| 64/40   | 164401 | 400 mm | 6   |
| 64/50   | 164500 | 500 mm | 6   |

Please note: image scale of products may vary.



**We like to be extraordinary.**  
Always looking for new solutions.

1

**Stuccoworker trowel, stainless.**

Hardened, 0.8 mm thick, stainless spring band steel blade, spot welded to stainless steel bar tang, wooden handle.

| Item No | EAN*   | Width  | Qty |
|---------|--------|--------|-----|
| 104R/4  | 110446 | 40 mm  | 12  |
| 104R/5  | 110453 | 50 mm  | 12  |
| 104R/6  | 110460 | 60 mm  | 12  |
| 104R/7  | 110477 | 70 mm  | 12  |
| 104R/8  | 110484 | 80 mm  | 12  |
| 104R/10 | 110415 | 100 mm | 12  |
| 104R/12 | 110422 | 120 mm | 12  |

III Made in Germany  
Made by Pajarito

**Stuccoworker trowel, stainless**

As Item No 104R, but standard version.

| Item No  | EAN*   | Width  | Qty |
|----------|--------|--------|-----|
| 8104R/4  | 682202 | 40 mm  | 12  |
| 8104R/5  | 682301 | 50 mm  | 12  |
| 8104R/6  | 500919 | 60 mm  | 12  |
| 8104R/7  | 682400 | 70 mm  | 12  |
| 8104R/8  | 500926 | 80 mm  | 12  |
| 8104R/10 | 500933 | 100 mm | 12  |
| 8104R/12 | 500940 | 120 mm | 12  |

III Made in Germany  
Made by Pajarito

**Stuccoworker trowel, stainless**

Polished, stainless steel, spot welded to stainless steel bar tang, ergonomically shaped 2-component plastic handle.

| Item No  | EAN*   | Width  | Qty |
|----------|--------|--------|-----|
| 5104R/6  | 100324 | 60 mm  | 12  |
| 5104R/8  | 505556 | 80 mm  | 12  |
| 5104R/10 | 505563 | 100 mm | 12  |

III Made in Germany  
Made by Pajarito



# PAJAFIX

## Embrasure spatula

1

### Smooth window and door embrasures in one go:

- + Guaranteed quick and smooth application
- + No snagging on window fixings
- + Made in Germany – Made by Pajarito

Ergonomically shaped  
2-component handle



Reinforced working edge for  
smooth, quick application



#### PAJAFIX embrasure spatula

The PAJAFIX embrasure spatula from Pajarito allows a trouble free and quick plastering of window and door embrasures in one go. The 2-component plastic handle is ergonomically shaped for safe handling. The aluminium profile with reinforced work edge guarantees a quick and smooth application.

| Item No | EAN*   | Width  | Qty |
|---------|--------|--------|-----|
| 5656/20 | 005278 | 200 mm | 3   |
| 5656/30 | 005285 | 300 mm | 3   |
| 5656/40 | 005308 | 400 mm | 3   |

# Environmentally friendly Comfort **cork handles**

1

## **Professional tools with environmentally friendly cork handles!**

Helps the environment: the newly developed handles made from natural cork are breathable and open pored, shock absorbing and better for joints, sweat-absorbing and regulate humidity between hand and handle. These give you a comfortable experience. Made in Germany.

**Better grab some!**

Joint friendly cork handles from our new eco-line.

---



The new cork handle programme can be found on the next pages.

**Tel.:** +49 2104/3000-0 **Fax:** +49 2104/16249 **Internet:** [www.pajarito.de](http://www.pajarito.de) <sup>19</sup>

# Cork handle scrapers

1



**III Made in Germany**  
**Made by Pajarito**

**Stripping scraper**  
 Hardened, flexible, dry-fined steel blade, ergonomically shaped cork handle.

| Item No | EAN*   | Width | Qty |
|---------|--------|-------|-----|
| 3002/6  | 026532 | 60 mm | 12  |
| 3002/8  | 026549 | 80 mm | 12  |



**III Made in Germany**  
**Made by Pajarito**



**Stuccoworker trowel, stainless**  
 Polished, stainless steel, spot welded to stainless steel bar tang, ergonomically shaped cork handle.

| Item No  | EAN*   | Length | Qty |
|----------|--------|--------|-----|
| 3104R/8  | 026570 | 80 mm  | 12  |
| 3104R/10 | 026693 | 100 mm | 12  |



**III Made in Germany**  
**Made by Pajarito**



**Plasterer trowel, stainless**  
 Polished stainless spring band steel blade, spot welded-on hardened, stainless steel bar tang, ergonomically shaped cork handle.

| Item No  | EAN*   | Length | Qty |
|----------|--------|--------|-----|
| 3100R/18 | 026525 | 180 mm | 6   |



**III Made in Germany**  
**Made by Pajarito**



**Plasterer bucket trowel, Bernese style, stainless**  
 Polished stainless spring band steel blade, spot welded-on hardened, stainless steel bar tang, ergonomically shaped cork handle..

| Item No  | EAN*   | Length | Qty |
|----------|--------|--------|-----|
| 3325R/16 | 026686 | 160 mm | 6   |

Please note: image scale of products may vary.

# Naturally in your hand.

## Taping knife with bit, stainless

Hardened, mirror finish spring band steel blade, 0.5 mm thick, stainless reinforcing plate, cork handle with inserted Phillips type bit.

| Item No | EAN*   | Width  | Qty |
|---------|--------|--------|-----|
| 3634R/B | 026518 | 150 mm | 6   |



III Made in Germany  
Made by Pajarito



## Plastic finishing trowel

Grey, impact resistant hard PVC blade, 190 mm long, plastic bonded backing, light alloy mounting, cork handle.

| Item No   | EAN*   | Dimensions       | Qty |
|-----------|--------|------------------|-----|
| 3092STG/2 | 026556 | 280 x 135 x 2 mm | 5   |



III Made in Germany  
Made by Pajarito

## Finishing trowel, stainless

Polished stainless steel blade, light alloy mounting, ergonomically shaped cork handle.

| Item No | EAN*   | Dimensions   | Qty |
|---------|--------|--------------|-----|
| 3093R   | 026563 | 280 x 130 mm | 5   |



III Made in Germany  
Made by Pajarito



## Cork grip spreader, stainless

Hardened, polished spring band steel, 0.4 mm thick, straight edges, machine fitted aluminium profile, cork handle, visible blade height 45 mm.

| Item No  | EAN*   | Width  | Qty |
|----------|--------|--------|-----|
| 3655R/25 | 029199 | 250 mm | 10  |
| 3655R/40 | 029205 | 400 mm | 10  |
| 3655R/50 | 029212 | 500 mm | 10  |
| 3655R/60 | 029229 | 600 mm | 10  |



III Made in Germany  
Made by Pajarito



1

# Trowels

1



**III Made in Germany**  
**Made by Pajarito**



**Plasterer trowel, stainless**

Hardened, high polished, stainless spring band steel blade, 1.0 mm thick, spot welded-on hardened, fine bright, stainless steel bar tang, wooden handle.

| Item No        | EAN*   | Length | Qty |
|----------------|--------|--------|-----|
| <b>100R/16</b> | 110163 | 160 mm | 6   |
| <b>100R/18</b> | 110187 | 180 mm | 6   |



**III Made in Germany**  
**Made by Pajarito**



**Plasterer trowel, stainless**

As Item No 100R, but standard version.

| Item No         | EAN*   | Length | Qty |
|-----------------|--------|--------|-----|
| <b>8100R/16</b> | 504870 | 160 mm | 6   |
| <b>8100R/18</b> | 500902 | 180 mm | 6   |



**III Made in Germany**  
**Made by Pajarito**



**Plasterer trowel, stainless**

Polished stainless spring band steel blade, spot welded-on hardened, stainless steel bar tang, ergonomically shaped 2-component plastic handle.

| Item No         | EAN*   | Length | Qty |
|-----------------|--------|--------|-----|
| <b>5100R/16</b> | 100300 | 160 mm | 6   |
| <b>5100R/18</b> | 505549 | 180 mm | 6   |



**III Made in Germany**  
**Made by Pajarito**



**Plasterer bucket trowel, Bernese style, stainless**

Hardened, polished stainless spring band steel blade, 1.0 mm thick, spot welded-on straight stainless steel bar tang, wooden handle.

| Item No        | EAN*   | Length | Qty |
|----------------|--------|--------|-----|
| <b>325R/14</b> | 132509 | 140 mm | 6   |
| <b>325R/16</b> | 132516 | 160 mm | 6   |



**III Made in Germany**  
**Made by Pajarito**



**Plasterer bucket trowel, stainless**

As Item No 325R, but standard version.

| Item No         | EAN*   | Length | Qty |
|-----------------|--------|--------|-----|
| <b>8325R/14</b> | 566298 | 140 mm | 6   |
| <b>8325R/16</b> | 501312 | 160 mm | 6   |



**III Made in Germany**  
**Made by Pajarito**



**Plast. trowel, Bern. style, stainless**

Polished stainless spring band steel blade, spot welded-on hardened, stainless steel bar tang, ergonomically shaped 2-component plastic handle.

| Item No         | EAN*   | Length | Qty |
|-----------------|--------|--------|-----|
| <b>5325R/14</b> | 505532 | 140 mm | 6   |
| <b>5325R/16</b> | 100560 | 160 mm | 6   |



**III Made in Germany**  
**Made by Pajarito**



**Trowel, French style, stainless**

French style: cat's tongue, hardened, high polished, stainless spring band steel blade, 0.7 mm thick, spot welded-on hardened, fine bright, stainless steel bar tang, wooden handle.

| Item No        | EAN*   | Length | Qty |
|----------------|--------|--------|-----|
| <b>181R/14</b> | 100188 | 140 mm | 6   |

Please note: image scale of products may vary.

**Rustication trowel, stainless**

Polished stainless steel blade, spot welded-on stainless steel bar tang, with plastic attachments, 1x tapered, 2x trapezoid.

| Item No | EAN*   | Dimensions   | Qty |
|---------|--------|--------------|-----|
| 102R    | 110439 | 110 x 120 mm | 1   |

**Trapezoid-replacement wedge, small**

| Item No | EAN*   | L x B x H        | Qty |
|---------|--------|------------------|-----|
| 102E/1  | 013518 | 103 x 25 x 16 mm | 1   |

**Trapezoid-replacement wedge, large**

|        |        |                  |   |
|--------|--------|------------------|---|
| 102E/2 | 013525 | 103 x 38 x 16 mm | 1 |
|--------|--------|------------------|---|

**Tapered-replacement wedge**

|        |        |                  |   |
|--------|--------|------------------|---|
| 102E/3 | 013532 | 103 x 26 x 13 mm | 1 |
|--------|--------|------------------|---|

III Made in Germany  
Made by Pajarito



Art.-Nr. 102E/2

Art.-Nr. 102E/1

Art.-Nr. 102E/3

**Inside corner trowel, stainless**

Acute angled, hardened, high polished, stainless spring band steel blade, 0.7 mm thick, stainless steel bar tang, wooden handle

| Item No | EAN*   | Dimensions   | Qty |
|---------|--------|--------------|-----|
| 309AR   | 103929 | 130 x 100 mm | 2   |
| 309AR/2 | 103943 | 65 x 65 mm   | 6   |

III Made in Germany  
Made by Pajarito

**Inside corner trowel, stainless, standard version**

Acute angled, hardened, high polished, stainless spring band steel blade, spot welded-on, stainless steel bar tang, wooden handle. Standard version.

| Item No | EAN*   | Dimensions  | Qty |
|---------|--------|-------------|-----|
| 8309R   | 610076 | 75 x 100 mm | 3   |

III Made in Germany  
Made by Pajarito

**Outside corner trowel, stainless**

Acute angled, hardened, high polished, stainless spring band steel blade, 0.7 mm thick, stainless steel bar tang, wooden handle

| Item No | EAN*   | Dimensions   | Qty |
|---------|--------|--------------|-----|
| 310AR   | 103363 | 130 x 100 mm | 2   |
| 310AR/2 | 103387 | 65 x 65 mm   | 6   |

III Made in Germany  
Made by Pajarito

**Outside corner trowel, stainless, standard version**

Acute angled, hardened, high polished, stainless spring band steel blade, spot welded-on, stainless steel bar tang, wooden handle. Standard version.

| Item No | EAN*   | Dimensions  | Qty |
|---------|--------|-------------|-----|
| 8310R   | 610120 | 75 x 100 mm | 3   |

III Made in Germany  
Made by Pajarito

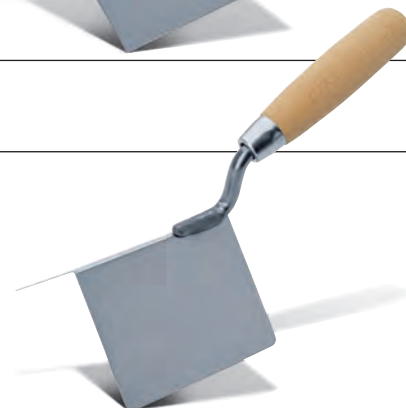



**Stuccoworker detail tool**

Hardened, fine ground, flexible flat steel blade, plastic sheath shank.

| Item No | EAN*   | Dimensions | Qty |
|---------|--------|------------|-----|
| 105/6   | 501053 | 6 mm       | 12  |
| 105/8   | 501060 | 8 mm       | 12  |
| 105/10  | 501077 | 10 mm      | 12  |
| 105/12  | 501084 | 12 mm      | 12  |
| 105/14  | 501091 | 14 mm      | 12  |
| 105/16  | 501107 | 16 mm      | 12  |
| 105/18  | 501114 | 18 mm      | 12  |
| 105/20  | 501121 | 20 mm      | 12  |
| 105/22  | 501138 | 22 mm      | 12  |
| 105/26  | 501145 | 26 mm      | 12  |
| 105/30  | 501169 | 30 mm      | 12  |

**Stuccoworker detail tool, stainless**

Hardened, fine ground, flexible flat stainless steel blade, plastic sheath shank.

|         |        |       |    |
|---------|--------|-------|----|
| 105R/10 | 009559 | 10 mm | 12 |
| 105R/16 | 009566 | 16 mm | 12 |
| 105R/20 | 009573 | 20 mm | 12 |
| 105R/26 | 009580 | 26 mm | 12 |
| 105R/30 | 009597 | 30 mm | 12 |

Made in Germany  
Made by Pajarito



**Pointing trowel**

Hardened, fine ground, flexible flat steel blade, wooden handle, 170 mm overall length.

| Item No | EAN*   | Dimensions | Qty |
|---------|--------|------------|-----|
| 106/6   | 501176 | 6 mm       | 12  |
| 106/8   | 501183 | 8 mm       | 12  |
| 106/10  | 501190 | 10 mm      | 12  |
| 106/12  | 501206 | 12 mm      | 12  |

Made in Germany  
Made by Pajarito



**Finishing trowel 'Golden Hit', stainless**

Extra tough, hardened, highly polished flat stainless steel blade, 0.7 mm thick, light alloy mounting, stainless steel rivets, curved wooden handle.

|       |        |              |   |
|-------|--------|--------------|---|
| 9292R | 192923 | 280 x 130 mm | 5 |
|-------|--------|--------------|---|

Made in Germany  
Made by Pajarito



**Finishing trowel, stainless**

Hardened, highly polished flat stainless steel blade, 0.7 mm thick, light alloy mounting, stainless steel rivets, curved wooden handle.

|     |        |              |   |
|-----|--------|--------------|---|
| 92R | 192312 | 280 x 130 mm | 5 |
|-----|--------|--------------|---|

Made in Germany  
Made by Pajarito









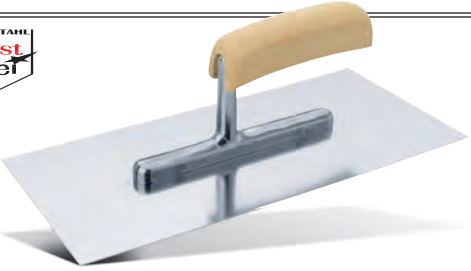

**Finishing trowel, stainless**

As Item No 92R, but with ergonomically shaped 2-component plastic handle.

|        |        |              |   |
|--------|--------|--------------|---|
| 5092RS | 017493 | 280 x 130 mm | 5 |
|--------|--------|--------------|---|

Please note: image scale of products may vary.

| <p><b>Finishing trowel, stainless, standard version</b></p> <p>Polished stainless steel blade, light alloy mounting, ergonomically shaped 2-component plastic handle.</p> <table border="1"> <thead> <tr> <th>Item No</th> <th>EAN*</th> <th>Dimensions</th> <th>Qty</th> </tr> </thead> <tbody> <tr> <td>5093R</td> <td>506836</td> <td>280 x 130 mm</td> <td>10</td> </tr> </tbody> </table>  | Item No | EAN*             | Dimensions | Qty | 5093R     | 506836 | 280 x 130 mm     | 10 | <p>Made in Germany<br/>Made by Pajarito</p>   |        |                  |    |  |        |                  |   |  |
|---|---------|------------------|------------|-----|-----------|--------|------------------|----|--|--------|------------------|----|--|--------|------------------|---|--|
| Item No   | EAN*    | Dimensions       | Qty        |     |           |        |                  |    |  |        |                  |    |  |        |                  |   |  |
| 5093R   | 506836  | 280 x 130 mm     | 10         |     |           |        |                  |    |  |        |                  |    |  |        |                  |   |  |
| <p><b>Finishing trowel, stainless</b></p> <p>Hardened, polished stainless steel blade, light alloy mounting, wooden handle. Standard version.</p> <table border="1"> <thead> <tr> <th>Item No</th> <th>EAN*</th> <th>Dimensions</th> <th>Qty</th> </tr> </thead> <tbody> <tr> <td>8092R</td> <td>570929</td> <td>280 x 130 mm</td> <td>10</td> </tr> </tbody> </table>  | Item No | EAN*             | Dimensions | Qty | 8092R     | 570929 | 280 x 130 mm     | 10 | <p>Made in Germany<br/>Made by Pajarito</p>   |        |                  |    |  |        |                  |   |  |
| Item No   | EAN*    | Dimensions       | Qty        |     |           |        |                  |    |  |        |                  |    |  |        |                  |   |  |
| 8092R   | 570929  | 280 x 130 mm     | 10         |     |           |        |                  |    |  |        |                  |    |  |        |                  |   |  |
| <p><b>Finishing trowel</b></p> <p>Hardened, highly polished spring band stainless steel blade, 0.7 mm thick, light alloy mounting, stainless steel rivets, round wooden handle.</p> <p>Also available with bevels on 3 sides:<br/>Item No 90 BW.</p> <table border="1"> <thead> <tr> <th>Item No</th> <th>EAN*</th> <th>Dimensions</th> <th>Qty</th> </tr> </thead> <tbody> <tr> <td>90/28</td> <td>190288</td> <td>280 x 135 mm</td> <td>5</td> </tr> <tr> <td>90BW</td> <td>190295</td> <td>280 x 140 mm</td> <td>10</td> </tr> </tbody> </table>                                     | Item No | EAN*             | Dimensions | Qty | 90/28     | 190288 | 280 x 135 mm     | 5  | 90BW   | 190295 | 280 x 140 mm     | 10 | <p>Made in Germany<br/>Made by Pajarito</p>    |        |                  |   |  |
| Item No   | EAN*    | Dimensions       | Qty        |     |           |        |                  |    |  |        |                  |    |  |        |                  |   |  |
| 90/28   | 190288  | 280 x 135 mm     | 5          |     |           |        |                  |    |  |        |                  |    |  |        |                  |   |  |
| 90BW  | 190295  | 280 x 140 mm     | 10         |     |           |        |                  |    |  |        |                  |    |  |        |                  |   |  |
| <p><b>Plastic finishing trowel with wooden handle</b></p> <p>Grey, impact resistant hard PVC blade, 190 mm long, plastic bonded backing, light alloy mounting, curved wooden handle.</p> <table border="1"> <thead> <tr> <th>Item No</th> <th>EAN*</th> <th>Dimensions</th> <th>Qty</th> </tr> </thead> <tbody> <tr> <td>092STG/1</td> <td>109303</td> <td>280 x 135 x 1 mm</td> <td>5</td> </tr> <tr> <td>092STG/2</td> <td>109273</td> <td>280 x 135 x 2 mm</td> <td>5</td> </tr> <tr> <td>092STG/3</td> <td>109280</td> <td>280 x 135 x 3 mm</td> <td>5</td> </tr> </tbody> </table> | Item No | EAN*             | Dimensions | Qty | 092STG/1  | 109303 | 280 x 135 x 1 mm | 5  | 092STG/2   | 109273 | 280 x 135 x 2 mm | 5  | 092STG/3   | 109280 | 280 x 135 x 3 mm | 5 | <p>Made in Germany<br/>Made by Pajarito</p>  |
| Item No   | EAN*    | Dimensions       | Qty        |     |           |        |                  |    |  |        |                  |    |  |        |                  |   |  |
| 092STG/1  | 109303  | 280 x 135 x 1 mm | 5          |     |           |        |                  |    |  |        |                  |    |  |        |                  |   |  |
| 092STG/2  | 109273  | 280 x 135 x 2 mm | 5          |     |           |        |                  |    |  |        |                  |    |  |        |                  |   |  |
| 092STG/3  | 109280  | 280 x 135 x 3 mm | 5          |     |           |        |                  |    |  |        |                  |    |  |        |                  |   |  |
| <p><b>Plastic finishing trowel with soft-grip handle</b></p> <p>Grey, impact resistant hard PVC blade, 190 mm long, plastic bonded backing, light alloy mounting, soft-grip handle.</p> <table border="1"> <thead> <tr> <th>Item No</th> <th>EAN*</th> <th>Dimensions</th> <th>Qty</th> </tr> </thead> <tbody> <tr> <td>5092STG/2</td> <td>027270</td> <td>280 x 135 x 2 mm</td> <td>5</td> </tr> <tr> <td>5092STG/3</td> <td>029243</td> <td>280 x 135 x 3 mm</td> <td>5</td> </tr> </tbody> </table>  | Item No | EAN*             | Dimensions | Qty | 5092STG/2 | 027270 | 280 x 135 x 2 mm | 5  | 5092STG/3  | 029243 | 280 x 135 x 3 mm | 5  | <p>Made in Germany<br/>Made by Pajarito</p>  |        |                  |   |  |
| Item No   | EAN*    | Dimensions       | Qty        |     |           |        |                  |    |  |        |                  |    |  |        |                  |   |  |
| 5092STG/2   | 027270  | 280 x 135 x 2 mm | 5          |     |           |        |                  |    |  |        |                  |    |  |        |                  |   |  |
| 5092STG/3   | 029243  | 280 x 135 x 3 mm | 5          |     |           |        |                  |    |  |        |                  |    |  |        |                  |   |  |
| <p><b>Plastic finishing trowel</b></p> <p>Blade and backing from PVC, 3.0 mm thick, light alloy mounting, wooden handle. Standard version.</p> <table border="1"> <thead> <tr> <th>Item No</th> <th>EAN*</th> <th>Dimensions</th> <th>Qty</th> </tr> </thead> <tbody> <tr> <td>8092ST</td> <td>630067</td> <td>280 x 130 mm</td> <td>5</td> </tr> </tbody> </table>   | Item No | EAN*             | Dimensions | Qty | 8092ST    | 630067 | 280 x 130 mm     | 5  | <p>Made in Germany<br/>Made by Pajarito</p>    |        |                  |    |  |        |                  |   |  |
| Item No   | EAN*    | Dimensions       | Qty        |     |           |        |                  |    |  |        |                  |    |  |        |                  |   |  |
| 8092ST  | 630067  | 280 x 130 mm     | 5          |     |           |        |                  |    |  |        |                  |    |  |        |                  |   |  |
| <p><b>Plastic finishing trowel</b></p> <p>Rigid PVC blade, 3.0 mm thick, plastic mounting and plastic handle. Standard version.</p> <table border="1"> <thead> <tr> <th>Item No</th> <th>EAN*</th> <th>Dimensions</th> <th>Qty</th> </tr> </thead> <tbody> <tr> <td>8092STG</td> <td>300939</td> <td>280 x 140 mm</td> <td>5</td> </tr> </tbody> </table>   | Item No | EAN*             | Dimensions | Qty | 8092STG   | 300939 | 280 x 140 mm     | 5  | <p>Made in Germany<br/>Made by Pajarito</p>    |        |                  |    |  |        |                  |   |  |
| Item No   | EAN*    | Dimensions       | Qty        |     |           |        |                  |    |  |        |                  |    |  |        |                  |   |  |
| 8092STG   | 300939  | 280 x 140 mm     | 5          |     |           |        |                  |    |  |        |                  |    |  |        |                  |   |  |

# Plastic finishing trowels

1

Made in Germany  
Made by Pajarito

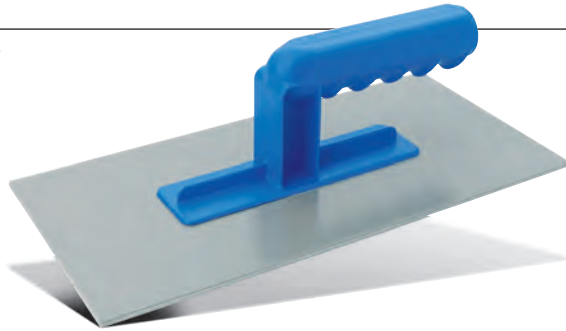

### Plastic finishing trowel 'Römerkelle'

Rigid PVC blade, 3.0 mm thick, plastic mounting and plastic handle.

| Item No | EAN*   | Dimensions   | Qty |
|---------|--------|--------------|-----|
| 8095    | 692409 | 280 x 135 mm | 5   |

Made in Germany

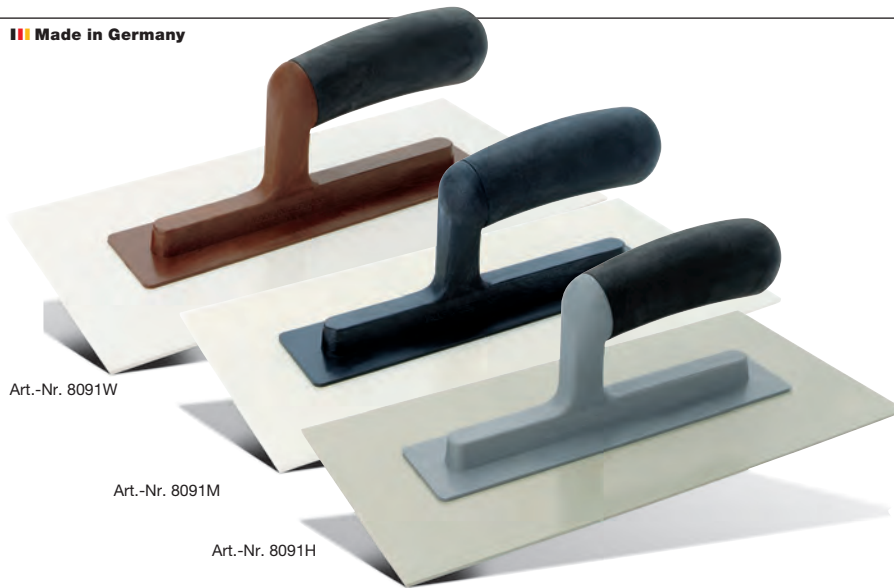

### Plastic finishing trowel, soft

Soft PVC blade, 3.0 mm thick, plastic mounting, ergonomical plastic soft grip handle, for coarse granulation > 3 mm.

| Item No | EAN*   | Dimensions   | Qty |
|---------|--------|--------------|-----|
| 8091W/2 | 009832 | 280 x 140 mm | 10  |

### Plastic finishing trowel, medium

As Item No 8091W, but with semi-rigid PVC blade, for medium granulation 2 – 3 mm.

|         |        |              |    |
|---------|--------|--------------|----|
| 8091M/3 | 009856 | 280 x 140 mm | 10 |
|---------|--------|--------------|----|

### Plastic finishing trowel, hard

As Item No 8091W, but with hard PVC blade, for fine granulation < 2 mm.

|         |        |              |    |
|---------|--------|--------------|----|
| 8091H/3 | 009863 | 280 x 140 mm | 10 |
|---------|--------|--------------|----|

Made in Germany  
Made by Pajarito



### Plastic finishing trowel

Grey, impact resistant hard PVC blade, 3.0 mm thick, 190 mm long, one blade end pointed with bevelled facet, plastic bonded backing, light alloy mounting, curved wooden handle.

| Item No | EAN*   | Dimensions   | Qty |
|---------|--------|--------------|-----|
| 092SP/3 | 109259 | 240 x 135 mm | 5   |

Made in Germany  
Made by Pajarito



### Plastic finishing trowel

PVC blade, 3.0 mm thick, one blade end pointed with bevelled facet, PVC backing, light alloy mounting, wooden handle. Standard version.

| Item No | EAN*   | Dimensions   | Qty |
|---------|--------|--------------|-----|
| 8092SP  | 630012 | 280 x 130 mm | 5   |

Please note: image scale of products may vary.

# Plastic finishing trowels

## Plastic mini trowel

Impact resistant hard PVC blade, 3.0 mm thick, plastic bonded backing, wooden handle.

III Made in Germany  
Made by Pajarito



| Item No | EAN*   | Dimensions  | Qty |
|---------|--------|-------------|-----|
| 092K    | 109228 | 160 x 80 mm | 6   |
| 092KS   | 109235 | 160 x 40 mm | 6   |

## Mini plastic trowel

Light coloured ABS-plastic blade, chamfered flanges. soft-grip handle, standard version.

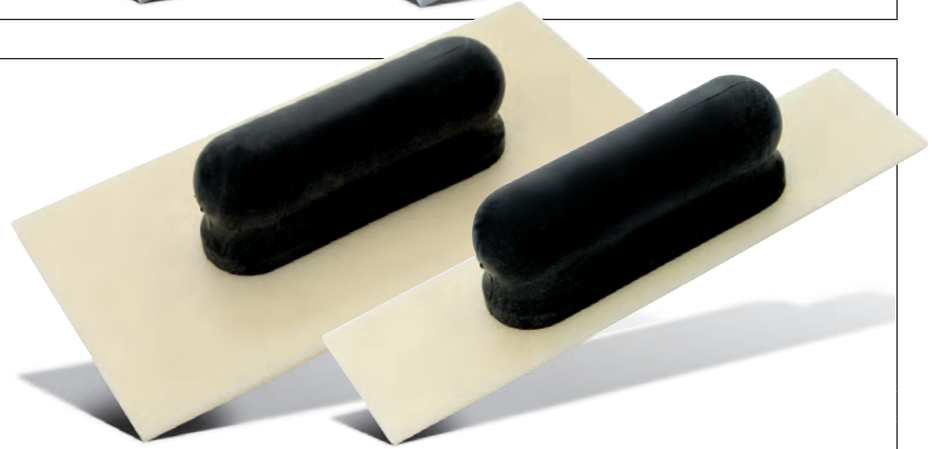

| Item No | EAN*   | Dimensions  | Qty |
|---------|--------|-------------|-----|
| 8092K   | 630081 | 160 x 80 mm | 10  |
| 8092KS  | 662105 | 160 x 40 mm | 10  |

## Mini plastic trowel

As Item No 092K, but one blade end pointed.

III Made in Germany  
Made by Pajarito



| Item No | EAN*   | Dimensions  | Qty |
|---------|--------|-------------|-----|
| 092SPK  | 109242 | 160 x 80 mm | 6   |

## Mini plastic trowel

As Item No 8092K, but one blade end pointed. Standard version.

| Item No | EAN*   | Dimensions  | Qty |
|---------|--------|-------------|-----|
| 8092SPK | 630166 | 160 x 40 mm | 10  |

## Mini plastic trowel

As Item No 092K, but round blade.

III Made in Germany  
Made by Pajarito



| Item No | EAN*   | Diameter | Qty |
|---------|--------|----------|-----|
| 092R    | 109297 | 100 mm   | 6   |

## Mini plastic trowel

As Item No 8092K, but round blade. Standard version.

| Item No | EAN*   | Diameter | Qty |
|---------|--------|----------|-----|
| 8092RK  | 630180 | 100 mm   | 10  |



| Float, polystyrene                    |        |              |     |
|---------------------------------------|--------|--------------|-----|
| Rectangular shape, 20 mm thick plate. |        |              |     |
| Item No                               | EAN*   | Dimensions   | Qty |
| 377                                   | 003960 | 270 x 130 mm | 5   |



| Float, polystyrene                      |        |              |     |
|---|--------|--------------|-----|
| Acute pointed shape. 25 mm thick plate. |        |              |     |
| Item No                                 | EAN*   | Dimensions   | Qty |
| 378                                     | 003977 | 320 x 180 mm | 5   |



| Float, plastic                               |        |              |     |
|--|--------|--------------|-----|
| Plate and handle made from expanded plastic. |        |              |     |
| Item No                                      | EAN*   | Dimensions   | Qty |
| 195K/28                                      | 519577 | 280 x 140 mm | 3   |

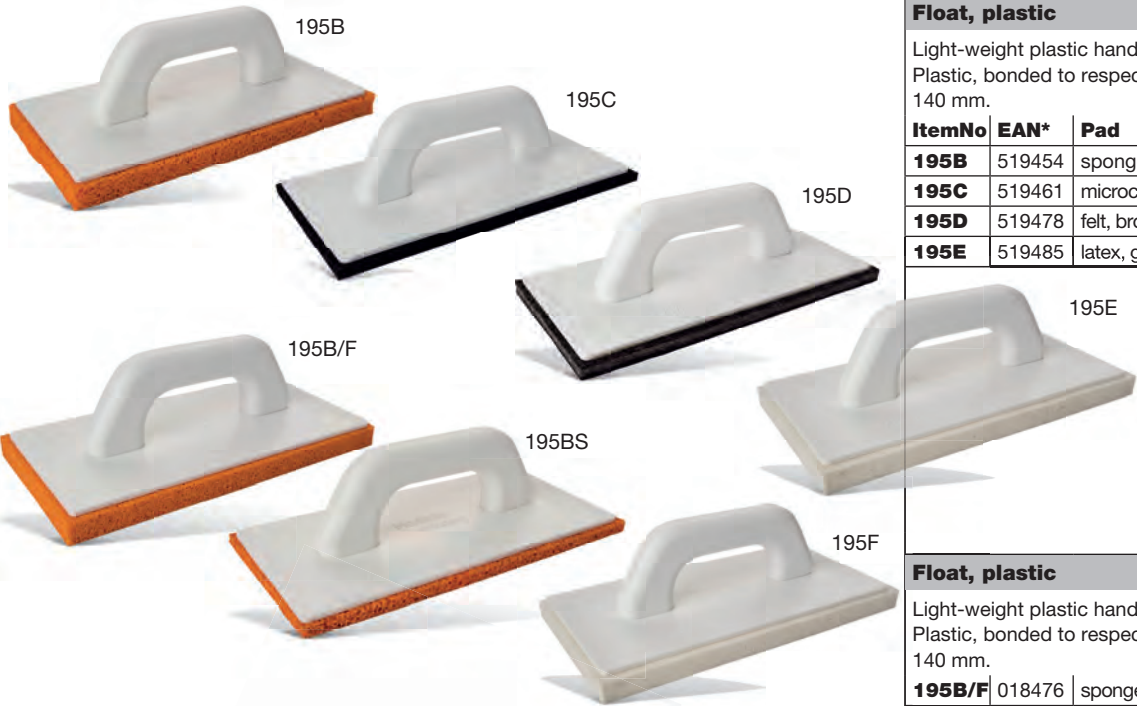

| Float, plastic   |        |                         |     |
|--|--------|-------------------------|-----|
| Light-weight plastic handle and backing plate<br>Plastic, bonded to respective pads size 280 x 140 mm. |        |                         |     |
| ItemNo   | EAN*   | Pad                     | Qty |
| 195B   | 519454 | sponge rubber 20mm      | 3   |
| 195C   | 519461 | microcell rubber, black | 3   |
| 195D   | 519478 | felt, brown             | 3   |
| 195E   | 519485 | latex, grey             | 3   |
| Float, plastic   |        |                         |     |
| Light-weight plastic handle and backing plate<br>Plastic, bonded to respective pads size 280 x 140 mm. |        |                         |     |
| 195B/F   | 018476 | sponge rubber, fine     | 3   |
| 195BS  | 024941 | sponge rubber, 10 mm    | 3   |
| 195F   | 017981 | neoprene                | 3   |



| Egalisette with aluminium handle  |        |              |     |
|---|--------|--------------|-----|
| Aluminium plate, bonded red sponge rubber, 20 mm thick, swivel mounted attachment for telescopic aluminium handle.<br>Handle is adjustable from 120 cm to 200 cm. |        |              |     |
| Item No   | EAN*   | Dimensions   | Qty |
| 857   | 668213 | 400 x 200 mm | 1   |

Please note: image scale of products may vary.

**Finishing trowel, stainless**

Hardened, polished stainless steel blade, stainless screws, screwed-on wooden handle.

| Item No | EAN*   | Dimensions         | Qty |
|---------|--------|--------------------|-----|
| 189R/13 | 118947 | 500 x 130 x 0,7 mm | 5   |
| 189R/18 | 118954 | 500 x 180 x 1,0 mm | 3   |

**Finishing trowel, standard version, stainless (no illustration)**

As Item No 189R. Standard version.

| Item No | EAN*   | Dimensions         | Qty |
|---------|--------|--------------------|-----|
| 8189R   | 505143 | 480 x 130 x 0,7 mm | 5   |

III Made in Germany  
Made by Pajarito

**Finishing trowel**

Hardened, polished spring band steel blade, screwed-on wooden handle. Also available 4-sided bevelled (Item No 189BW/14).

| Item No  | EAN*   | Dimensions         | Qty |
|----------|--------|--------------------|-----|
| 189/14   | 118916 | 500 x 130 x 0,7 mm | 5   |
| 189BW/14 | 118909 | 500 x 180 x 1,0 mm | 5   |
| 189/18   | 118923 | 500 x 180 x 1,0 mm | 3   |

**Finishing trowel (no illustration)**

As Item No 189, standard version.

| Item No | EAN*   | Width              | Qty |
|---------|--------|--------------------|-----|
| 8189    | 004233 | 480 x 130 x 0,7 mm | 5   |

III Made in Germany  
Made by Pajarito

**Finishing trowel for screeders**

Hardened, polished rectangular spring steel blade, 0,7 mm thick, light-alloy mounting, ergonomically shaped wooden handle.

| Item No | EAN*   | Dimensions   | Qty |
|---------|--------|--------------|-----|
| 860/30  | 186038 | 300 x 115 mm | 5   |
| 860/40  | 186045 | 400 x 115 mm | 3   |
| 860/50  | 186052 | 500 x 115 mm | 3   |
| 860/60  | 186069 | 600 x 115 mm | 3   |

III Made in Germany  
Made by Pajarito

**Finishing trowel for screeders**

As Item No 860, but with pointed, rounded blade, width head 70 mm, heel 115 mm.

| Item No | EAN*   | Dimensions | Qty |
|---------|--------|------------|-----|
| 861/50  | 186151 | 500 mm     | 5   |
| 861/60  | 186158 | 600 mm     | 3   |
| 861/70  | 186175 | 700 mm     | 3   |

III Made in Germany  
Made by Pajarito

**Finishing trowel for screeders**

Polished, non-hardened steel blade, 2,0 mm thick, bent up rear corners, mild-steel mounting wooden handle, blade width head 90 mm, heel 160 mm.

| Item No | EAN*   | Dimensions | Qty |
|---------|--------|------------|-----|
| 671/2   | 167105 | 470 mm     | 2   |

III Made in Germany  
Made by Pajarito

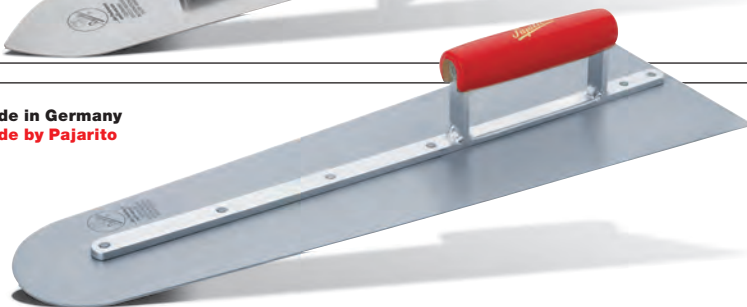
**Floorlayer trowel**

Long mounting, red handle, standard version. Item No 8302LS/60 = version with long mounting

| Item No   | EAN*   | Dimensions | Qty |
|-----------|--------|------------|-----|
| 8302/40   | 011958 | 400 mm     | 5   |
| 8302/50   | 011965 | 500 mm     | 5   |
| 8302/60   | 011972 | 600 mm     | 5   |
| 8302/70   | 011996 | 700 mm     | 3   |
| 8302/80   | 012009 | 800 mm     | 5   |
| 8302LS/60 | 011989 | 600 mm     | 5   |

III Made in Germany  
Made by Pajarito

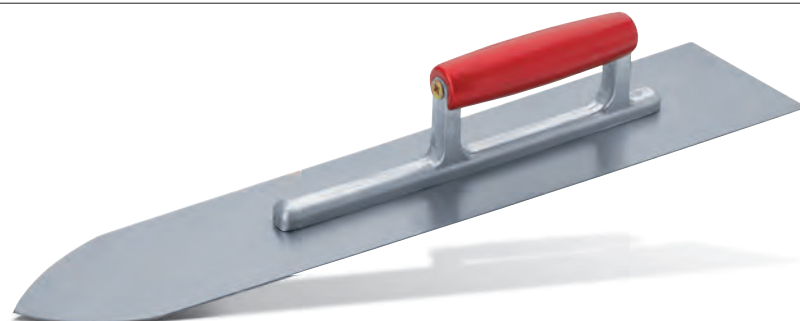

1

# Hands on.

**Order and tools, craftsman and producer: in terms of collaboration our customers give us top grades. We are your partner for tools. Always there for you as a competent contact. Promised! Pajarito: building on trust; since 1923.**

1



**EDELSTAHL Rost frei**

**Floor finishing trowel, stainless**

Head and heel rounded stainless blade, reinforced light-alloy mounting, large rifled wooden handle.

| Item No        | EAN*   | Dimensions       | Qty |
|----------------|--------|------------------|-----|
| <b>860R/42</b> | 027362 | 425 x 125 x 1 mm | 3   |

**Made in Germany Made by Pajarito**



**EDELSTAHL Rost frei**

**Marble-effect spatula, stainless**

Hardened, special stainless steel, 0.6 mm thick, rounded edges, absolutely ridge-free and polished flanges, fibreglass reinforced bracket, ergonomically shaped 2-component plastic handle. Delivered with edge-protection strips.

| Item No        | EAN*   | Dimensions      | Qty |
|----------------|--------|-----------------|-----|
| <b>863R/20</b> | 002048 | 200 x 80/70     | 5   |
| <b>863R/24</b> | 002055 | 240 x 100/80 mm | 5   |
| <b>863R/28</b> | 002062 | 280 x 100/90 mm | 5   |

**Made in Germany Made by Pajarito**



**EDELSTAHL Rost frei**

**Marble-effect spatula, stainless**

Hardened, special stainless steel, 0.6 mm thick, edges ridge-free, fibreglass reinforced bracket, unpainted wooden handle. Delivered with edge-protection strips.

| Item No        | EAN*   | Dimensions      | Qty |
|----------------|--------|-----------------|-----|
| <b>864R/20</b> | 101093 | 200 x 80 mm     | 5   |
| <b>864R/24</b> | 002079 | 240 x 100/90 mm | 5   |
| <b>864R/28</b> | 101086 | 280 x 100/90 mm | 5   |



**EDELSTAHL Rost frei**

**Venetian style spatula, stainless**

Hardened, polished special stainless steel, 0.6 mm thick, rounded edges, absolutely ridge free and polished flanges, light alloy mounting, ergonomically shaped 2-component plastic handle. Standard version.

| Item No         | EAN*   | Dimensions       | Qty |
|-----------------|--------|------------------|-----|
| <b>8862R/20</b> | 681670 | 200 x 80 mm      | 5   |
| <b>8862R/24</b> | 681779 | 240 x 110/90 mm  | 5   |
| <b>8862R/28</b> | 681809 | 240 x 120/100 mm | 5   |

Please note: image scale of products may vary.

# Finishing trowel **PAJAQUICK**

1

## For optimally finished Q3 and Q4 surfaces

- + Lighter with novel plastic support
- + Almost ridge-free finish
- + Blade from 0.5 mm special stainless steel
- + Available in 300 and 350 mm
- + Made in Germany –  
Made by Pajarito

Waxed wooden handle  
Item No 866R



Ergonomically shaped soft  
grip handle Item No 5866R



### Finishing trowel PAJAQUICK

The new PAJAQUICK finishing trowel meets the latest demands for optimally finished surfaces according to Q3 and Q4.

The blade made from special stainless steel has rounded edges to enable an almost ridge-free finish on walls and ceilings. Simultaneously, the weight reduction through the novel light-weight plastic support is a huge plus for the user. Available with ergonomically shaped soft grip handle or waxed wooden handle.

| Item No                    | EAN*   | Dimensions   | Qty |
|----------------------------|--------|--------------|-----|
| <b>Waxed wooden handle</b> |        |              |     |
| 866R/30                    | 027393 | 300 x 110 mm | 5   |
| 866R/35                    | 027409 | 350 x 110 mm | 3   |
| <b>Soft grip handle</b>    |        |              |     |
| 5866R/30                   | 029069 | 300 x 110 mm | 5   |
| 5866R/35                   | 029076 | 350 x 110 mm | 3   |

Developed in conjunction with leading  
filler producers.



# Finishing spreader **PAJAQUICK**

1

## **Timesaving, ergonomical, accurate**

- + Finish Q3 und Q4 surfaces in one go
- + Anodised aluminium holder for accurate, timesaving work
- + Exchangeable stainless steel blades for different applications
- + Made in Germany – Made by Pajarito

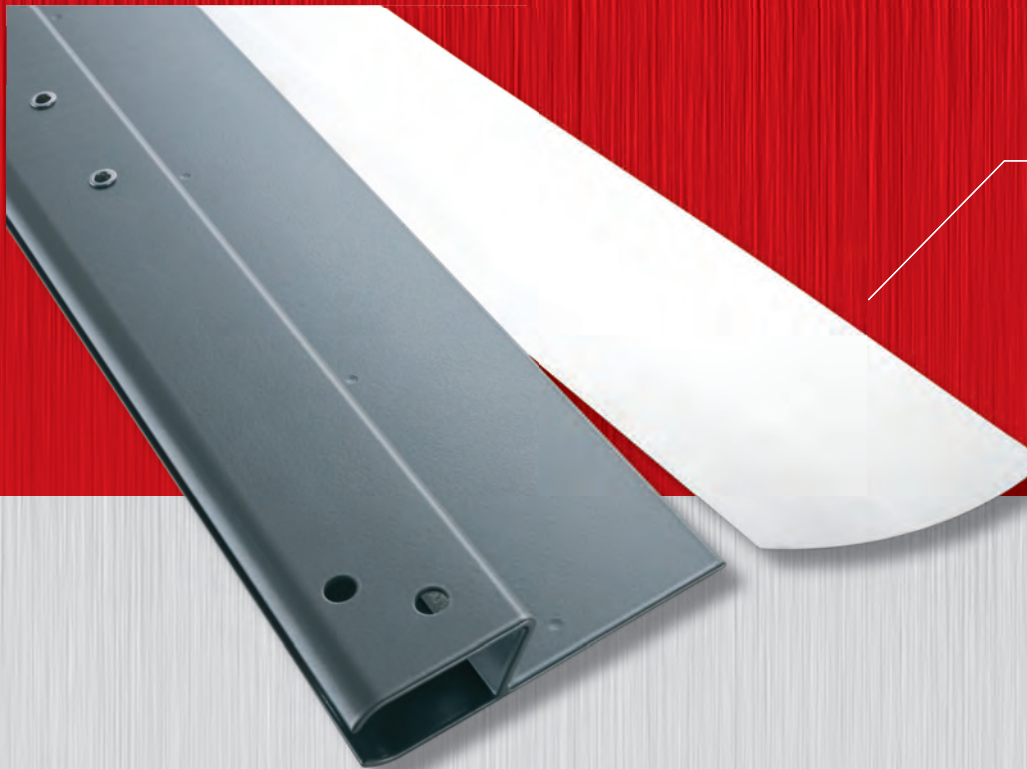

Exchangeable stainless  
blades included



Convincing speed and best results!

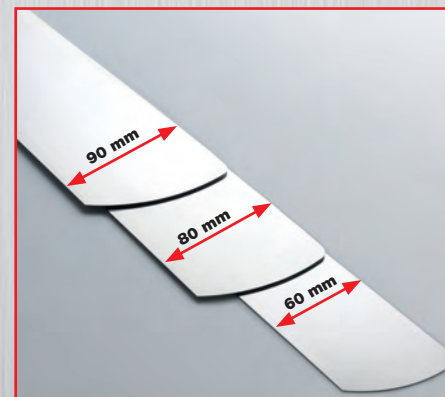



## For Q3 to Q4 surfaces, 30-200 cm wide.

### PAJAQUICK Plus 6

- + Stainless steel blade 60 mm wide, 0.5 mm thick.
- + Precise, sharp edged smoothing-over in one go.
- + Ideally suited for cement and lime-cement plaster.

### PAJAQUICK Plus 8 Optimised for up to quality level Q3

- + Stainless steel blade 80 mm wide, 0.5 mm thick.
- + Precise, sharp edged smoothing-over and simultaneous finishing. Depending on the material, an additional finishing, i.e. with a finishing trowel, can be dispensed with.
- + Ideally suited for finishing of gypsum and fibrous plaster, as well as mesh-embedding and filling of gypsum-board joints.

### PAJAQUICK Plus 9 Optimised for up to quality level Q4

- + Stainless steel blade 90 mm wide, 0.3 mm thick.
- + For simple, large surface finishing.
- + Ideally suited for smoothing-over of spray render, thin coat render and synthetic render.

### Finishing spreader PAJAQUICK

incl. 1 hardened, polished, stainless spring band steel blade

|           | Plus 6 60 x 0.5 mm |        | Plus 8 80 x 0.5 mm |        | Plus 9 90 x 0.3 mm |        |
|-----------|--------------------|--------|--------------------|--------|--------------------|--------|
| Length cm | Item No            | EAN*   | Item No            | EAN*   | Item No            | EAN*   |
| 30        | 7656R/30/6         | 024170 | 7656R/30/8         | 024194 | 7656R/30/9         | 024217 |
| 40        | 7656R/40/6         | 024187 | 7656R/40/8         | 024200 | 7656R/40/9         | 024224 |
| 60        | 7656R/60/6         | 021353 | 7656R/60/8         | 021360 | 7656R/60/9         | 021377 |
| 80        | 7656R/80/6         | 021384 | 7656R/80/8         | 021391 | 7656R/80/9         | 021407 |
| 100       | 7656R/100/6        | 021261 | 7656R/100/8        | 021278 | 7656R/100/9        | 021285 |
| 120       | 7656R/120/6        | 021292 | 7656R/120/8        | 021308 | 7656R/120/9        | 021315 |
| 150       | 7656R/150/6        | 021322 | 7656R/150/8        | 021339 | 7656R/150/9        | 021346 |
| 200       | 7656R/200/6        | 021643 | 7656R/200/8        | 021650 | -                  | -      |

### Spare blades

Hardened, polished, stainless spring band steel, for all finishing spreaders PAJAQUICK Plus 6 up to Plus 9.

|           | Plus 6 60 x 0.5 mm |        | Plus 8 80 x 0.5 mm |        | Plus 9 90 x 0.3 mm |        |
|-----------|--------------------|--------|--------------------|--------|--------------------|--------|
| Length cm | Item No            | EAN*   | Item No            | EAN*   | Item No            | EAN*   |
| 30        | 7656RE/30/6        | 024231 | 7656RE/30/8        | 024255 | 7656RE/30/9        | 024279 |
| 40        | 7656RE/40/6        | 024248 | 7656RE/40/8        | 024262 | 7656RE/40/9        | 024286 |
| 60        | 7656RE/60/6        | 021513 | 7656RE/60/8        | 021520 | 7656RE/60/9        | 021537 |
| 80        | 7656RE/80/6        | 021544 | 7656RE/80/8        | 021551 | 7656RE/80/9        | 021568 |
| 100       | 7656RE/100/6       | 021421 | 7656RE/100/8       | 021438 | 7656RE/100/9       | 021445 |
| 120       | 7656RE/120/6       | 021452 | 7656RE/120/8       | 021469 | 7656RE/120/9       | 021476 |
| 150       | 7656RE/150/6       | 021483 | 7656RE/150/8       | 021490 | 7656RE/150/9       | 021506 |
| 200       | 7656RE/200/6       | 021674 | 7656RE/200/8       | 021681 | -                  | -      |

Notched blades available on request.

## Useful accessories for finishing spreader PAJAQUICK:



### Accessories

**Hinge set - Quick holders**  
for overhead or floor applications.

| Item No | EAN*   | Illustration |
|---------|--------|--------------|
| 7661    | 021704 | 1            |

**Aluminium shaft for hinge set**  
Aluminium tube, 1500 mm long, 30 mm dia., for overhead or floor applications.

|      |        |   |
|------|--------|---|
| 7658 | 021711 | 2 |
|------|--------|---|

**Height adjustment set**

|      |        |   |
|------|--------|---|
| 7659 | 021728 | 3 |
|------|--------|---|

**Handle knob for cleaning u. Smoothness spatula**

|      |        |   |
|------|--------|---|
| 7660 | 031932 | 4 |
|------|--------|---|

# Professional Loam plaster trowel

1

## Perfection trowels – Made in Japan!

- + Even more flexible through laser cutting technology
- + The right trowel for any render: from the first roughing to the perfect finish



Highly flexible support through laser cutting technology.



**Finishing** work with plastic blade

### Japanese finishing trowel

Fine, flexible, special plastic blade, 1.0 mm thick. Particularly useful for finishing work.

| Item No | EAN*   | Dimensions      | Qty |
|---------|--------|-----------------|-----|
| 903/18  | 017578 | 180 x 55 x 1 mm | 6   |
| 903/21  | 017585 | 210 x 60 x 1 mm | 6   |



## Coarse work

### Japanese finishing trowel, stainless

Very fine, rectangular, flexible, hardened, polished stainless steel blade, 0.4 mm thick. Highly flexible support through laser cutting technology. Particularly useful for initial coarse work.

| Item No | EAN*   | Dimensions        | Qty |
|---------|--------|-------------------|-----|
| 900/24  | 017509 | 240 x 75 x 0,4 mm | 6   |
| 900/27  | 017516 | 270 x 85 x 0,4 mm | 6   |



## Intermediate work

### Japanese finishing trowel, stainless

As Item No 900, but with rounded blade head, 0.3 mm thick. Particularly useful for intermediate work.

| Item No | EAN*   | Dimensions        | Qty |
|---------|--------|-------------------|-----|
| 901/24  | 017523 | 240 x 80 x 0,3 mm | 6   |
| 901/27  | 017530 | 270 x 90 x 0,3 mm | 6   |



## Finishing work

### Japanese finishing trowel, stainless

As Item No 900, but with pointed blade head, 0.3 mm thick. Particularly useful for finishing work.

| Item No | EAN*   | Dimensions        | Qty |
|---------|--------|-------------------|-----|
| 902/15  | 017547 | 150 x 55 x 0,3 mm | 6   |
| 902/18  | 017554 | 180 x 55 x 0,3 mm | 6   |
| 902/21  | 017561 | 210 x 65 x 0,3 mm | 6   |

# Rabo-Speed

1



Made in Germany  
Made by Pajarito



### Rabo-Speed, stainless

Render scraper for fast removal of plaster sinter layer, newly styled grip for even better handling traction.

| Item No | EAN*   | Dimensions   | Qty |
|---------|--------|--------------|-----|
| 613     | 007104 | 260 x 260 mm | 1   |



Made in Germany  
Made by Pajarito



### Rabo-Speed mini, stainless

Render scraper for removal of plaster sinter layer and scraping of wall and ceiling areas.

| Item No | EAN*   | Dimensions   | Qty |
|---------|--------|--------------|-----|
| 613K    | 007340 | 180 x 180 mm | 1   |



Made in Germany  
Made by Pajarito



### Rabo - Speed Mini

As Item No 613K, but with hinge for shaft instead of a handle.

| Item No | EAN*   | Dimensions   | Qty |
|---------|--------|--------------|-----|
| 613K/G  | 027416 | 180 x 180 mm | 5   |

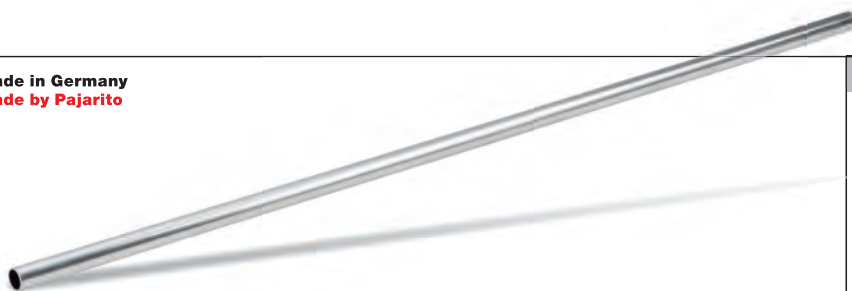

Made in Germany  
Made by Pajarito

### Aluminium shaft

Aluminium tube, 1.500 mm long, 30 mm dia., for overhead or floor applications.

| Item No | EAN*   | Dimensions        | Qty |
|---------|--------|-------------------|-----|
| 7658    | 021711 | 150cm - 30mm dia. | 1   |

Please note: image scale of products may vary.

| <b>Stucco scratcher</b>   |        |             |     |
|---|--------|-------------|-----|
| Hardened, pointed steel pins, 20 mm visible length, plastic body, web loop. |        |             |     |
| Item No   | EAN*   | Dimensions  | Qty |
| 326   | 503262 | 170 x 90 mm | 6   |

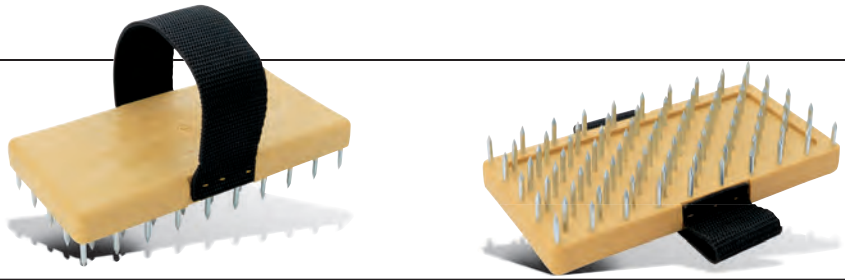

| <b>Roughcast applicator, Tyrolean, complete</b>  |        |                                  |     |
|--|--------|----------------------------------|-----|
| Aluminium body, adjustable tension bar, bearing bushes, armrest, lid. Delivery includes handle and spring steel comb assembly, 140 mm diameter.. |        |                                  |     |
| Item No  | EAN*   |                                  | Qty |
| 2000N  | 027287 |                                  | 1   |
| 2000NE   | 027294 | Spare spring steel comb assembly | 1   |

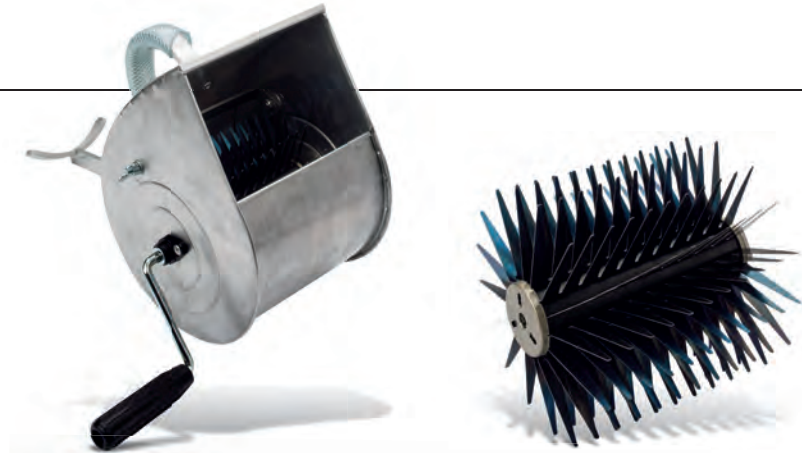

| <b>Plasterer plane grid, notched</b>                    |        |              |     |
|---|--------|--------------|-----|
| Zinc-plated steel, ergonomically shaped plastic handle. |        |              |     |
| Item No   | EAN*   | Dimensions   | Qty |
| 614Z  | 020769 | 280 x 140 mm | 1   |



| <b>Plasterer plane grid</b>                             |        |              |     |
|---|--------|--------------|-----|
| Zinc-plated steel, ergonomically shaped plastic handle. |        |              |     |
| Item No   | EAN*   | Dimensions   | Qty |
| 614   | 506140 | 280 x 140 mm | 1   |

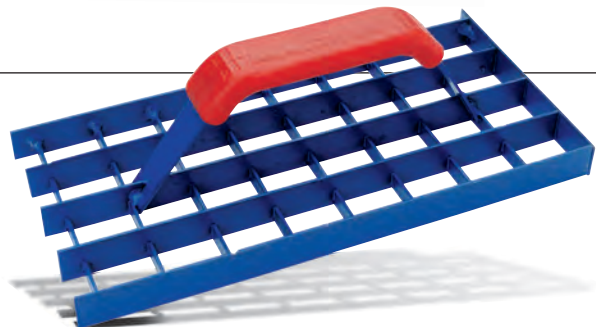

| <b>Angle plane</b>                      |        |             |     |
|---|--------|-------------|-----|
| Light alloy, trapezoid, 8 steel blades. |        |             |     |
| Item No                                 | EAN*   | Dimensions  | Qty |
| 615                                     | 506157 | 445 x 90 mm | 1   |

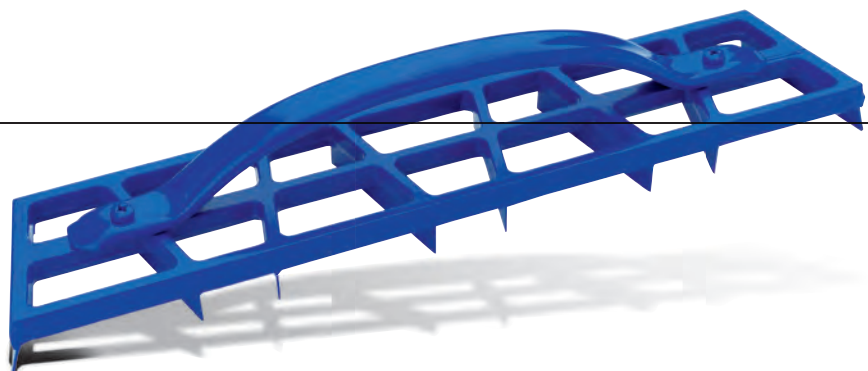

1



Made in Germany  
Made by Pajarito  
EDELSTAHL  
Rost  
frei

**Spreader trowel, stainless**

Polished stainless steel blade, light alloy mounting, ergonomically shaped 2-component plastic handle. Head edge and one side edge notched. Following choice of notch styles. (See also pages 46/47.)

| Item No     | EAN*   | Dimensions   | Qty |
|-------------|--------|--------------|-----|
| 5093RZ/2/C1 | 027423 | 280 x 130 mm | 5   |
| 5093RZ/2/C2 | 018483 | 280 x 130 mm | 5   |
| 5093RZ/2/C4 | 018490 | 280 x 130 mm | 5   |
| 5093RZ/2/C5 | 018506 | 280 x 130 mm | 5   |
| 5093RZ/2/T9 | 027461 | 280 x 130 mm | 5   |
| 5093RZ/2/M1 | 027478 | 280 x 130 mm | 5   |
| 5093RZ/2/HO | 027485 | 280 x 130 mm | 5   |



Made in Germany  
Made by Pajarito  
EDELSTAHL  
Rost  
frei

**Spreader trowel, stainless**

Hardened, polished stainless steel blade, light alloy mounting, wooden handle. Head edge and one side edge notched. Following choice of notch styles. (See also pages 46/47.)

| Item No     | EAN*   | Dimensions   | Qty |
|-------------|--------|--------------|-----|
| 8092RZ/2/C1 | 101260 | 280 x 130 mm | 5   |
| 8092RZ/2/C2 | 570936 | 280 x 130 mm | 5   |
| 8092RZ/2/C4 | 693208 | 280 x 130 mm | 5   |
| 8092RZ/2/C5 | 570943 | 280 x 130 mm | 5   |
| 8092RZ/2/T9 | 101277 | 280 x 130 mm | 5   |
| 8092RZ/2/M1 | 027492 | 280 x 130 mm | 5   |
| 8092RZ/2/HO | 027508 | 280 x 130 mm | 5   |



Made in Germany  
Made by Pajarito

**Spreader trowel for large areas**

Hardened, polished spring band steel blade, 0.7 mm thick, screwed-on wooden handle. Head edge and one side edge notched with either TKB notch styles C1, C2, C3 or C4, as well as Pajarito notch styles 48, 70 or 71. (See also pages 46/47.)

| Item No | EAN*   | Dimensions   | Qty |
|---------|--------|--------------|-----|
| 189Z/C1 | 100966 | 500 x 140 mm | 5   |
| 189Z/C2 | 100539 | 500 x 140 mm | 5   |
| 189Z/C3 | 100522 | 500 x 140 mm | 5   |
| 189Z/C4 | 100980 | 500 x 140 mm | 5   |
| 189Z/48 | 100973 | 500 x 140 mm | 5   |
| 189Z/70 | 100997 | 500 x 140 mm | 5   |
| 189Z/71 | 101000 | 500 x 140 mm | 5   |



Made in Germany  
Made by Pajarito

**Notching nippers**

Nickel-plated steel, for re-notching of spreader notches, exchangeable die and die plate.

| Item No                | EAN*   | Qty |
|------------------------|--------|-----|
| 940                    | 594031 | 1   |
| <b>Spare die</b>       |        |     |
| 940E                   | 594048 | 1   |
| <b>Spare die plate</b> |        |     |
| 940ES                  | 594055 | 1   |

Please note: image scale of products may vary.

**Spreader**

Hardened, polished spring band steel blade, 0.7 mm thick, 40 mm wide waxed wood handle. Choice of TKB notch styles A1, A2, B1, B2, or B3, as well as Pajarito notch style 4. (See also pages 46/47.)

| Item No   | EAN*   | Dimensions   | Qty |
|-----------|--------|--------------|-----|
| 390/18/A1 | 139027 | 180 x 100 mm | 12  |
| 390/18/A2 | 139386 | 180 x 100 mm | 12  |
| 390/18/4  | 139614 | 180 x 100 mm | 12  |
| 390/18/B1 | 139010 | 180 x 100 mm | 12  |
| 390/18/B2 | 139423 | 180 x 100 mm | 12  |
| 390/18/B3 | 139430 | 180 x 100 mm | 12  |
| 390/25/A1 | 139058 | 250 x 100 mm | 6   |
| 390/25/A2 | 139508 | 250 x 100 mm | 6   |
| 390/25/4  | 139621 | 250 x 100 mm | 6   |
| 390/25/B1 | 139041 | 250 x 100 mm | 6   |
| 390/25/B2 | 139546 | 250 x 100 mm | 6   |
| 390/25/B3 | 139553 | 250 x 100 mm | 6   |

**Spreader, stainless (no illu.)**

As Item No 390, but stainless. Choice of TKB notch styles A1, A2, or B.

| Item No    | EAN*   | Dimensions   | Qty |
|------------|--------|--------------|-----|
| 390R/18/A1 | 100928 | 180 x 100 mm | 12  |
| 390R/18/A2 | 100935 | 180 x 100 mm | 12  |
| 390R/18/B1 | 100942 | 180 x 100 mm | 12  |



Made in Germany  
Made by Pajarito

**Notched spreader (no illustration)**

Trapezoid steel blade and wooden handle, Choice of TKB notch styles A3, B1, or C1. Standard version.

| Item No | EAN*   | Dimensions  | Qty |
|---------|--------|-------------|-----|
| 8391/A3 | 630890 | 180 x 85 mm | 12  |
| 8391/B1 | 630906 | 180 x 85 mm | 12  |
| 8391/C1 | 630913 | 180 x 85 mm | 12  |

**Notched spreader**

Trapezoid steel blade and wooden handle, Choice of TKB notch styles A3, B1, or C1. Standard version. (See also pages 46/47.)

| Item No | EAN*   | Dimensions  | Qty |
|---------|--------|-------------|-----|
| 8392/A3 | 631019 | 250 x 85 mm | 12  |
| 8392/B1 | 631064 | 250 x 85 mm | 12  |
| 8392/C1 | 631309 | 250 x 85 mm | 12  |



Made in Germany  
Made by Pajarito

**Notched applying spreader**

Hardened, polished spring band steel blade, 0.4 mm thick, 50 mm wide waxed wood handle. Blade with TKB notch style B1. (See also pages 46/47.)

| Item No | EAN*   | Dimensions   | Qty |
|---------|--------|--------------|-----|
| 64Z/20  | 164227 | 200 x 100 mm | 12  |
| 64Z/30  | 164319 | 300 x 100 mm | 6   |
| 64Z/50  | 164517 | 500 x 100 mm | 6   |



Made in Germany  
Made by Pajarito

**Applying knife, notched**

Hardened, flexible, dry-fined steel blade, gently curved, waxed beech handle, riveted full-length tang. Blade with TKB notch style B1. (See also pages 46/47.)

| Item No | EAN*   | Dimensions | Qty |
|---------|--------|------------|-----|
| 2Z/6    | 102366 | 60 mm      | 12  |
| 2Z/8    | 102373 | 80 mm      | 12  |
| 2Z/10   | 102380 | 100 mm     | 12  |
| 2Z/12   | 102397 | 120 mm     | 12  |



Made in Germany  
Made by Pajarito

**Notched spreader**

Plastic, 4 differently notched sides.

| Item No | EAN*   | Dimensions  | Qty |
|---------|--------|-------------|-----|
| 8632    | 763208 | 130 x 90 mm | 12  |

# PAJARITO- Exchangeable trowel

1

## Any work – one handle

- + Innovative mounting system
- + Left or right handed use, as the notched side can be mounted either way
- + High longevity
- + Made in Germany – Made by Pajarito

Ergonomically shaped  
2-component plastic handle

Waxed wooden handle



**Finishing trowel application:**  
spreading and finishing.

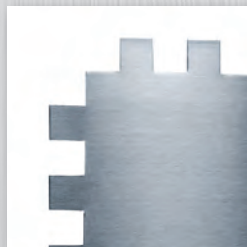

**Finishing trowel application C2:**  
applying tile-cement or reinforcement adhesive (i.e. wall tiles or material).



**Finishing trowel application C5:**  
For applying tile-cement or reinforcement adhesive (i.e. floor tiles or insulation blocks).



**The Innovative PAJARITO mounting system.**

### Spreader trowel

Hardened, polished stainless steel. Head side and right side notched with TKB notch style C5 (10x10x10 mm).

### Spreader trowel

Hardened, polished stainless steel. Head side and right side notched with TKB notch style C2 (6x6x6 mm).

### Finishing trowel

Smooth version. All 3 blades made from polished, stainless steel.

Fixation points for the mounting system.



1

### Accessory: Spare plastic blade 998E/K

To be used as a float attachment.



### Any work - one handle

| Item No     | EAN*     | Dimensions                             | Qty |
|-------------|----------|--|-----|
| <b>998H</b> | 022336   | <b>Trowel blade set wooden handle</b>  | 1   |
|             | Content: | 1x each 998E, 998E/Z/26, 998E/Z77      |     |
| <b>998S</b> | 022343   | <b>Trowel blade set plastic handle</b> | 1   |
|             | Content: | 1x each 998E, 998E/Z/26, 998E/Z77      |     |

### Accessories

|                  |        |                                      |   |
|------------------|--------|--------------------------------------|---|
| <b>998E</b>      | 022374 | Spare blade, stainless, smooth       | 1 |
| <b>998E/Z/26</b> | 022381 | Spare blade, stainless, notch TKB C2 | 1 |
| <b>998E/Z/77</b> | 022398 | Spare blade, stainless, notch TKB C5 | 1 |
| <b>998E/K</b>    | 022640 | Spare blade, plastic 2 mm            | 1 |
| <b>998E/H</b>    | 022350 | Spare handle, wood                   | 1 |
| <b>998E/S</b>    | 022367 | Spare handle, plastic                | 1 |
| <b>998E/VK</b>   | 022404 | Sealable caps, 2 pcs.                | 1 |

Made in Germany  
Made by Pajarito



**Coloquick spreader**

To be used with exchangeable hard aluminium notched blades, welded-on holder. Notched blade not included. For notch styles see pages 46/47.

| Item No           | EAN*   | Dimensions   | Qty |
|-------------------|--------|--------------|-----|
| <b>777/18/O.Z</b> | 177722 | 180 x 130 mm | 10  |
| <b>777/28/O.Z</b> | 177760 | 280 x 130 mm | 10  |

Made in Germany  
Made by Pajarito



**Spreader, stainless**

To be used with exchangeable notched blades, with hardened, highly polished stainless steel blade, welded-on holder, 40 mm wide wooden handle. Notched blade not included. For notch styles see pages 46/47.

| Item No        | EAN*   | Dimensions   | Qty |
|----------------|--------|--------------|-----|
| <b>779R/18</b> | 177944 | 180 x 100 mm | 12  |
| <b>779R/21</b> | 177951 | 210 x 100 mm | 6   |
| <b>779R/28</b> | 177968 | 280 x 100 mm | 6   |

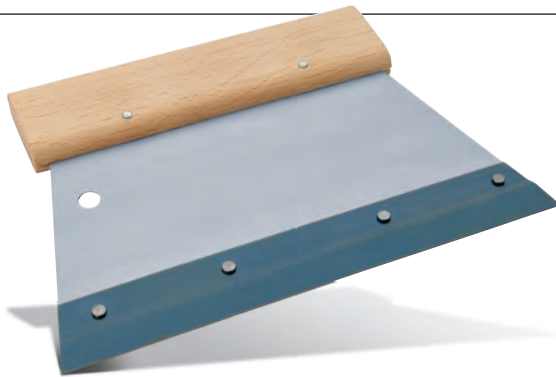

**Spreader**

As Item No 779R, but not stainless. Standard version.

| Item No        | EAN*   | Dimensions   | Qty |
|----------------|--------|--------------|-----|
| <b>8779/18</b> | 019930 | 180 x 100 mm | 12  |
| <b>8779/21</b> | 007692 | 210 x 100 mm | 6   |
| <b>8779/28</b> | 017936 | 280 x 100 mm | 6   |

Made in Germany  
Made by Pajarito



**Spreader trowel, stainless**

To be used with exchangeable notched blades, with hardened, highly polished stainless spring band steel blade, 0.6 mm thick, welded-on stainless, light alloy mounting, round wooden handle.

Notched blade not included. For notch styles see pages 46/47.

| Item No          | EAN*   | Dimensions   | Qty |
|------------------|--------|--------------|-----|
| <b>999R/O.Z.</b> | 199892 | 280 x 100 mm | 6   |

Made in Germany  
Made by Pajarito



**Spreader trowel, stainless**

As Item No 999R/O.Z., but with ergonomically shaped plastic handle.

| Item No           | EAN*   | Dimensions   | Qty |
|-------------------|--------|--------------|-----|
| <b>5999R/O.Z.</b> | 014348 | 280 x 100 mm | 6   |

Please note: image scale of products may vary.



Pajarito Warenhandels-gesellschaft mbH

**PAJARITO**  
WERKZEUGE



# Inking & Paint rollers



[www.pajarito.de](http://www.pajarito.de)

**Please request our inking and paint roller  
catalogue: +49 2104 / 3000-0**

# Notched blades Standard

III Made in Germany  
Made by Pajarito

Art.-Nr. 779E/18/A

Art.-Nr. 779E/21/A

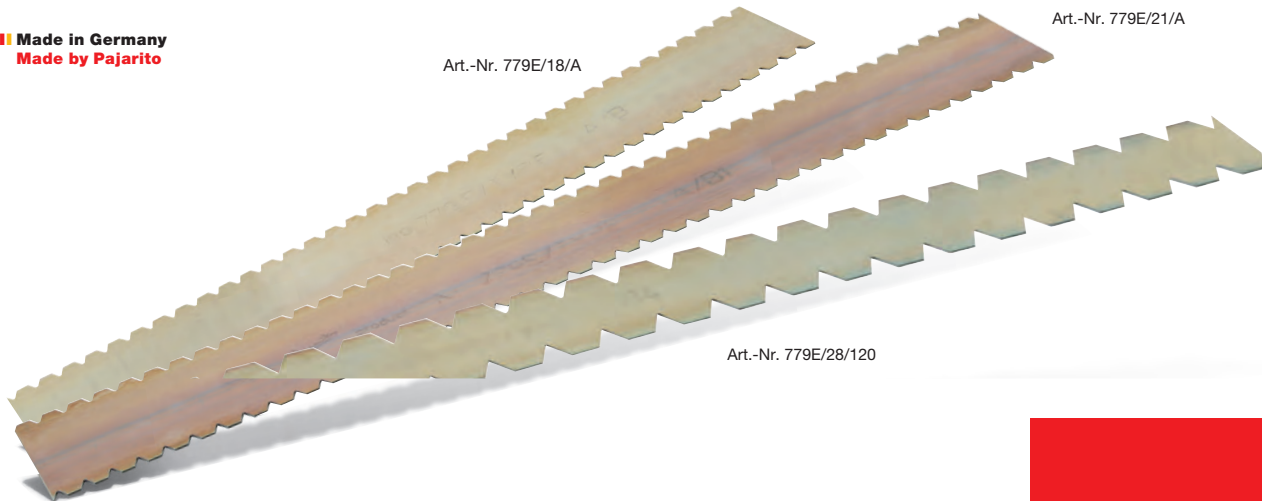

Art.-Nr. 779E/28/120

### Notched blade, standard

Hardened, spring band steel, 0.5 mm thick, 25 mm wide. Available in these length: 180 mm, 210 mm and 280 mm.  
**Available only with TKB notch styles.**  
For notch styles in original size, see pages 46/47.  
Packing unit: 12 pcs.

## TKB notch styles

| Notched blade standard 180 mm length |         |        |
|--------------------------------------|---------|--------|
| Item No                              | Type No | EAN*   |
| 779E/18/                             | A1      | 951018 |
| 779E/18/                             | A2      | 951032 |
| 779E/18/                             | A3      | 951230 |
| 779E/18/                             | A4      | 951407 |
| 779E/18/                             | A5      | 951643 |
| 779E/18/                             | B1      | 941019 |
| 779E/18/                             | B2      | 941033 |
| 779E/18/                             | B3      | 941149 |
| 779E/18/                             | B5      | 003342 |
| 779E/18/                             | B6      | 001584 |
| 779E/18/                             | B7      | 002635 |
| 779E/18/                             | B8      | 026730 |
| 779E/18/                             | B9      | 001904 |
| 779E/18/                             | B10     | 001874 |
| 779E/18/                             | B11     | 174059 |
| 779E/18/                             | B12     | 023487 |
| 779E/18/                             | B13     | 005001 |
| 779E/18/                             | B14     | 014720 |
| 779E/18/                             | B15     | 002628 |
| 779E/18/                             | B16     | 014201 |
| 779E/18/                             | B17     | 013129 |
| 779E/18/                             | C1      | 961369 |
| 779E/18/                             | C2      | 961260 |
| 779E/18/                             | C3      | 961352 |
| 779E/18/                             | C4      | 961499 |
| 779E/18/                             | C5      | 003724 |
| 779E/18/                             | S1      | 015024 |
| 779E/18/                             | S2      | 001591 |
| 779E/18/                             | S3      | 022633 |
| 779E/18/                             | S4      | 961673 |
| 779E/18/                             | R1      | 003809 |
| 779E/18/                             | R2      | 003830 |
| 779E/18/                             | R3      | 022619 |

| Notched blade standard 210 mm length |         |        |
|--------------------------------------|---------|--------|
| Item No                              | Type No | EAN*   |
| 779E/21/                             | A1      | 952015 |
| 779E/21/                             | A2      | 952039 |
| 779E/21/                             | A3      | 952237 |
| 779E/21/                             | A4      | 952404 |
| 779E/21/                             | A5      | 952640 |
| 779E/21/                             | B1      | 942016 |
| 779E/21/                             | B2      | 942030 |
| 779E/21/                             | B3      | 942146 |
| 779E/21/                             | B5      | 007661 |
| 779E/21/                             | B6      | 011873 |
| 779E/21/                             | B7      | 003588 |
| 779E/21/                             | B8      | 003526 |
| 779E/21/                             | B9      | 001911 |
| 779E/21/                             | B10     | 001881 |
| 779E/21/                             | B11     | 174035 |
| 779E/21/                             | B12     | 002413 |
| 779E/21/                             | B13     | 005018 |
| 779E/21/                             | B14     | 003649 |
| 779E/21/                             | B15     | 017752 |
| 779E/21/                             | B16     | 003670 |
| 779E/21/                             | B17     | 003700 |
| 779E/21/                             | C1      | 962366 |
| 779E/21/                             | C2      | 962267 |
| 779E/21/                             | C3      | 962359 |
| 779E/21/                             | C4      | 001621 |
| 779E/21/                             | C5      | 003731 |
| 779E/21/                             | S1      | 025832 |
| 779E/21/                             | S2      | 001607 |
| 779E/21/                             | S3      | 025658 |
| 779E/21/                             | S4      | 962670 |
| 779E/21/                             | R1      | 003816 |
| 779E/21/                             | R2      | 024910 |
| 779E/21/                             | R3      | 003861 |

| Notched blade standard 280 mm length |         |        |
|--------------------------------------|---------|--------|
| Item No                              | Type No | EAN*   |
| 779E/28/                             | A1      | 953012 |
| 779E/28/                             | A2      | 953036 |
| 779E/28/                             | A3      | 953234 |
| 779E/28/                             | A4      | 953401 |
| 779E/28/                             | A5      | 953647 |
| 779E/28/                             | B1      | 943013 |
| 779E/28/                             | B2      | 943037 |
| 779E/28/                             | B3      | 943143 |
| 779E/28/                             | B5      | 019602 |
| 779E/28/                             | B6      | 015109 |
| 779E/28/                             | B7      | 003595 |
| 779E/28/                             | B8      | 003533 |
| 779E/28/                             | B9      | 001928 |
| 779E/28/                             | B10     | 001898 |
| 779E/28/                             | B11     | 174042 |
| 779E/28/                             | B12     | 007494 |
| 779E/28/                             | B13     | 022626 |
| 779E/28/                             | B14     | 002024 |
| 779E/28/                             | B15     | 002017 |
| 779E/28/                             | B16     | 014195 |
| 779E/28/                             | B17     | 003717 |
| 779E/28/                             | C1      | 963363 |
| 779E/28/                             | C2      | 963264 |
| 779E/28/                             | C3      | 963356 |
| 779E/28/                             | C4      | 963493 |
| 779E/28/                             | C5      | 003748 |
| 779E/28/                             | S1      | 001980 |
| 779E/28/                             | S2      | 001614 |
| 779E/28/                             | S3      | 006428 |
| 779E/28/                             | S4      | 963677 |
| 779E/28/                             | R1      | 001973 |
| 779E/28/                             | R2      | 001997 |
| 779E/28/                             | R3      | 019558 |

## Ordering notched blades is really simple

### 1. Choose notch quality:

You have the choice between 2 grades: The standard Quality (Item No. 779e) for normal use and high-quality special steel (Item No. 777E) with a longer life for harder use.

### 2. Choose notch length:

You can choose between 180, 210 and 280 mm Length at normal execution or 180 and 280 mm for the special steel version. The figure for the length is placed after the item number (e.g. B. Item No. 777E / 28 for a special steel notched blade with a length of 280 mm).

### 3. Choose notch style:

On page 46/47 all notch profiles are shown in actual size. Pick what you want or, when re-ordering, match your sample with a pattern of the printed notch profiles. If you have the matching notch pattern, write the pattern number (Type No, black column) after the item number with the length (i.e. Item No. 777E / 28 / B7 for a special steel notched blade in 280 mm length with Pajarito tooth form B7).

**Sounds complicated at first, but is really quite simple in reality. Promised!**

| Notched blade special steel 560 mm length |         |        |
|---|---------|--------|
| Item No                                   | Type No | EAN*   |
| 779E/56/                                  | R1      | 001294 |
| 779E/56/                                  | R2      | 019763 |
| 779E/56/                                  | R3      | 003519 |

Please note: image scale of products may vary.

# Notched blades Special steel

Made in Germany  
Made by Pajarito

Art.-Nr. 777E/28/A

Art.-Nr. 777E/18/A

## Notched blade, special steel

Strong, especially abrasion resistant, tough special steel, 0.5 mm thick, 25 mm wide.

Available in these length:  
180 mm and 280 mm.

**Available with TKB and Pajarito notch styles.**

For notch styles in original size, see pages 46/47.

Packing unit: 12 pcs.

## TKB notch styles

| Notched blade special steel<br>180 mm length |         |        | Notched blade special steel<br>280 mm length |         |        |
|--|---------|--------|--|---------|--------|
| Item No                                      | Type No | EAN*   | Item No                                      | Type No | EAN*   |
| 777E/18/                                     | A1      | 921011 | 777E/28/                                     | A1      | 923015 |
| 777E/18/                                     | A2      | 921035 | 777E/28/                                     | A2      | 923039 |
| 777E/18/                                     | A3      | 921233 | 777E/28/                                     | A3      | 923237 |
| 777E/18/                                     | A4      | 921400 | 777E/28/                                     | A4      | 923404 |
| 777E/18/                                     | A5      | 921646 | 777E/28/                                     | A5      | 923640 |
| 777E/18/                                     | B1      | 911012 | 777E/28/                                     | B1      | 913016 |
| 777E/18/                                     | B2      | 911036 | 777E/28/                                     | B2      | 913030 |
| 777E/18/                                     | B3      | 911142 | 777E/28/                                     | B3      | 913146 |
| 777E/18/                                     | B5      | 931560 | 777E/28/                                     | B5      | 933564 |
| 777E/18/                                     | B6      | 001249 | 777E/28/                                     | B6      | 001256 |
| 777E/18/                                     | B7      | 001263 | 777E/28/                                     | B7      | 001270 |
| 777E/18/                                     | B8      | 001287 | 777E/28/                                     | B8      | 003335 |
| 777E/18/                                     | B9      | 001300 | 777E/28/                                     | B9      | 001317 |
| 777E/18/                                     | B10     | 001324 | 777E/28/                                     | B10     | 001331 |
| 777E/18/                                     | B11     | 911944 | 777E/28/                                     | B11     | 913948 |
| 777E/18/                                     | B12     | 001348 | 777E/28/                                     | B12     | 018643 |
| 777E/18/                                     | B13     | 001362 | 777E/28/                                     | B13     | 001379 |
| 777E/18/                                     | B14     | 001386 | 777E/28/                                     | B14     | 001393 |
| 777E/18/                                     | B15     | 001409 | 777E/28/                                     | B15     | 001416 |
| 777E/18/                                     | B16     | 001423 | 777E/28/                                     | B16     | 001430 |
| 777E/18/                                     | B17     | 001126 | 777E/28/                                     | B17     | 001119 |
| 777E/18/                                     | C1      | 931362 | 777E/28/                                     | C1      | 933366 |
| 777E/18/                                     | C2      | 931263 | 777E/28/                                     | C2      | 933267 |
| 777E/18/                                     | C3      | 931355 | 777E/28/                                     | C3      | 933359 |
| 777E/18/                                     | C4      | 931492 | 777E/28/                                     | C4      | 933496 |
| 777E/18/                                     | C5      | 931775 | 777E/28/                                     | C5      | 933779 |
| 777E/18/                                     | S1      | 931058 | 777E/28/                                     | S1      | 933052 |
| 777E/18/                                     | S2      | 931935 | 777E/28/                                     | S2      | 933939 |
| 777E/18/                                     | S3      | 001447 | 777E/28/                                     | S3      | 001454 |
| 777E/18/                                     | S4      | 931676 | 777E/28/                                     | S4      | 933670 |
| 777E/18/                                     | R1      | 931461 | 777E/28/                                     | R1      | 933465 |
| 777E/18/                                     | R2      | 931553 | 777E/28/                                     | R2      | 933557 |
| 777E/18/                                     | R3      | 931973 | 777E/28/                                     | R3      | 933977 |

## Pajarito notch styles

| Notched blade special steel<br>180 mm length |         |        | Notched blade special steel<br>280 mm length |         |        |
|--|---------|--------|--|---------|--------|
| Item No                                      | Type No | EAN*   | Item No                                      | Type No | EAN*   |
| 777E/18/                                     | E       | 911067 | 777E/28/                                     | E       | 913061 |
| 777E/18/                                     | K       | 921073 | 777E/28/                                     | K       | 923077 |
| 777E/18/                                     | 4       | 911043 | 777E/28/                                     | 4       | 913047 |
| 777E/18/                                     | 7       | 931072 | 777E/28/                                     | 7       | 933076 |
| 777E/18/                                     | 11      | 921110 | 777E/28/                                     | 11      | 923114 |
| 777E/18/                                     | 17      | 911173 | 777E/28/                                     | 17      | 913177 |
| 777E/18/                                     | 25      | 911258 | 777E/28/                                     | 25      | 913252 |
| 777E/18/                                     | 29      | 931294 | 777E/28/                                     | 29      | 933298 |
| 777E/18/                                     | 30      | 931300 | 777E/28/                                     | 30      | 933304 |
| 777E/18/                                     | 34      | 921349 | 777E/28/                                     | 34      | 923343 |
| 777E/18/                                     | 44      | 931447 | 777E/28/                                     | 44      | 933441 |
| 777E/18/                                     | 48      | 931485 | 777E/28/                                     | 48      | 933489 |
| 777E/18/                                     | 54      | 931546 | 777E/28/                                     | 54      | 933540 |
| 777E/18/                                     | 61      | 921615 | 777E/28/                                     | 61      | 923619 |
| 777E/18/                                     | 66      | 911661 | 777E/28/                                     | 66      | 913665 |
| 777E/18/                                     | 68      | 911685 | 777E/28/                                     | 68      | 913689 |
| 777E/18/                                     | 69      | 911692 | 777E/28/                                     | 69      | 913696 |
| 777E/18/                                     | 78      | 931782 | 777E/28/                                     | 78      | 933786 |
| 777E/18/                                     | 79      | 931799 | 777E/28/                                     | 79      | 933793 |
| 777E/18/                                     | 92      | 931928 | 777E/28/                                     | 92      | 933922 |
| 777E/18/                                     | 95      | 931959 | 777E/28/                                     | 95      | 933953 |

## Notched blade special steel 180 mm length

| Item No  | Type No | EAN*   |
|----------|---------|--------|
| 777E/56/ | R1      | 005216 |
| 777E/56/ | R2      | 934004 |
| 777E/56/ | R3      | 005223 |

# TKB notch styles (full-scale)

## TKB-A

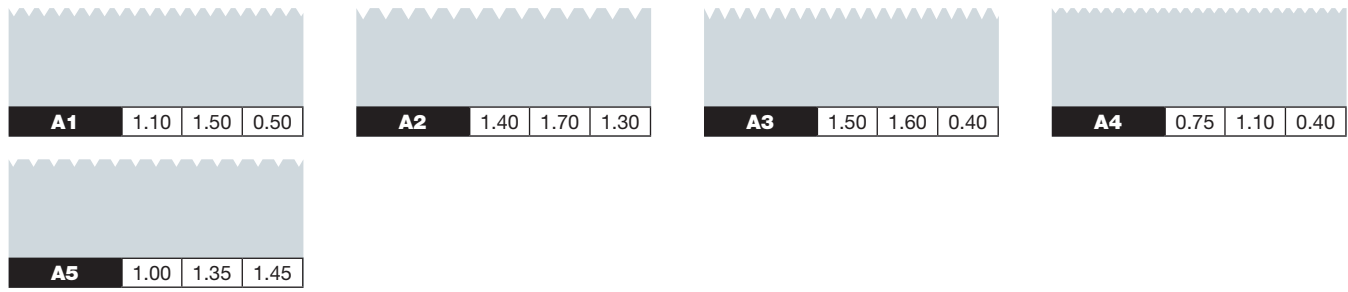

## TKB-B

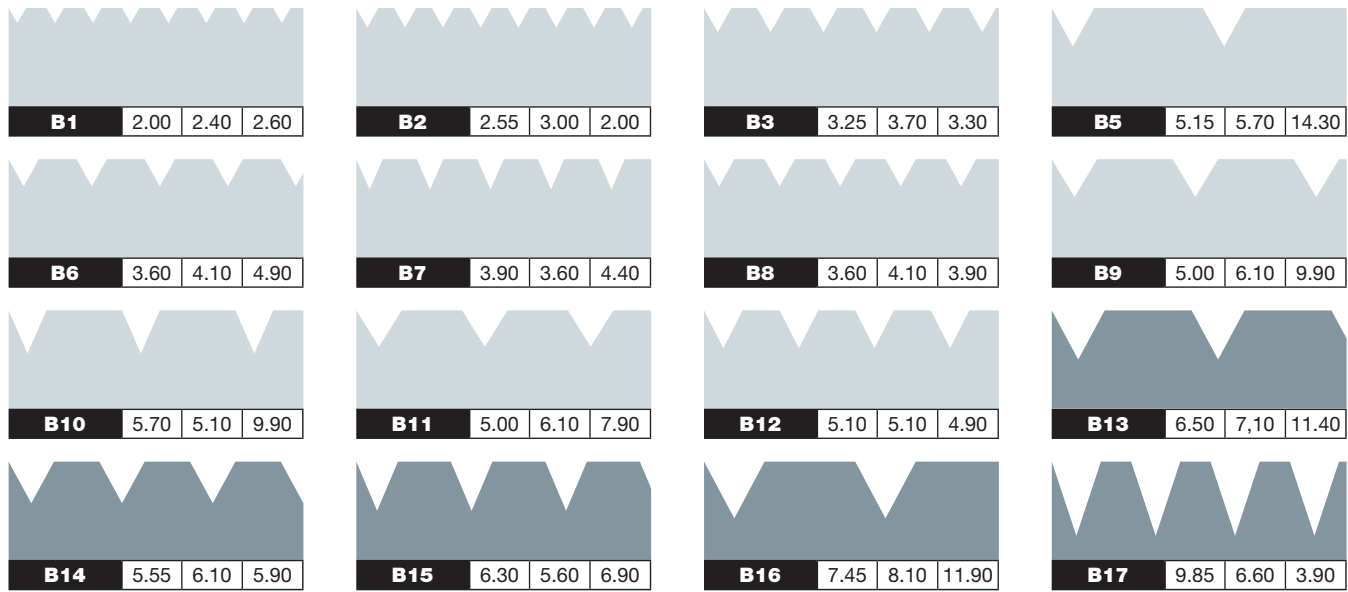

## TKB-C

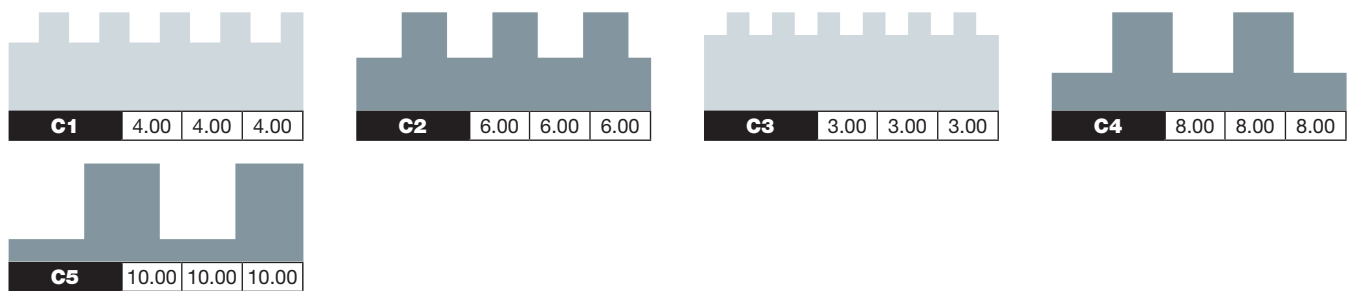

## TKB-S

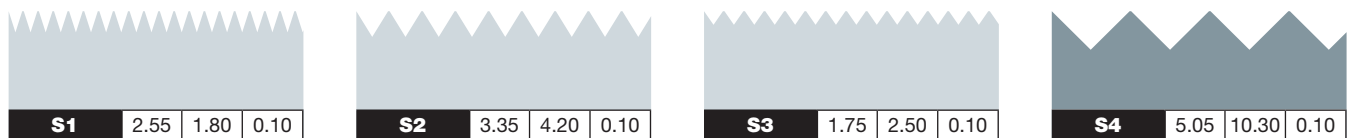

## TKB-R

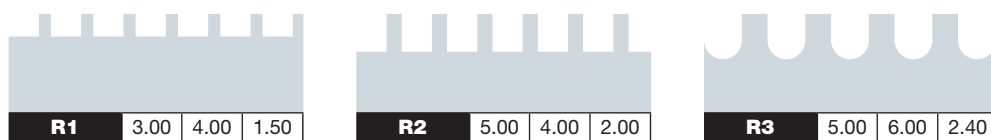

## TKB-M trowel notches (not available as notched blades!)

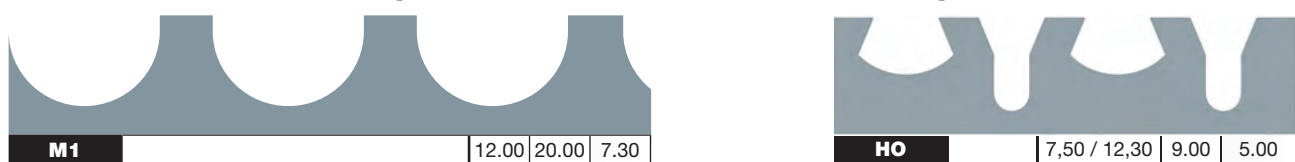

Please note: image scale of products may vary.

# Pajarito notch styles (full-scale)

## Pajarito coarse

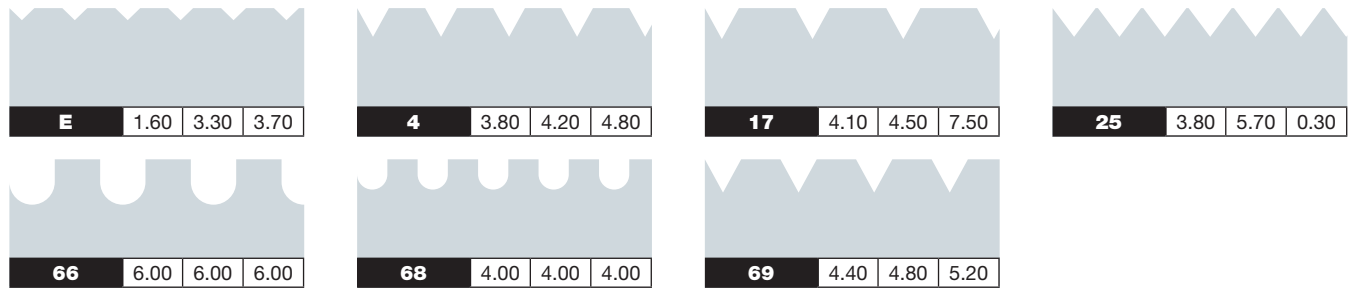

## Pajarito fine

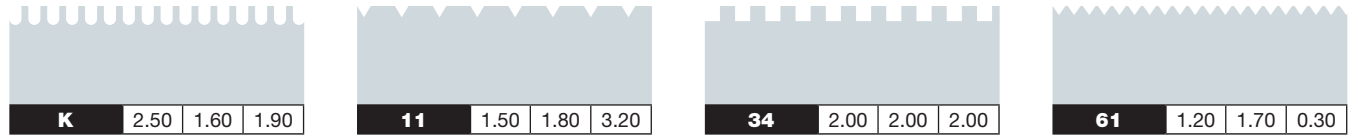

## Pajarito special

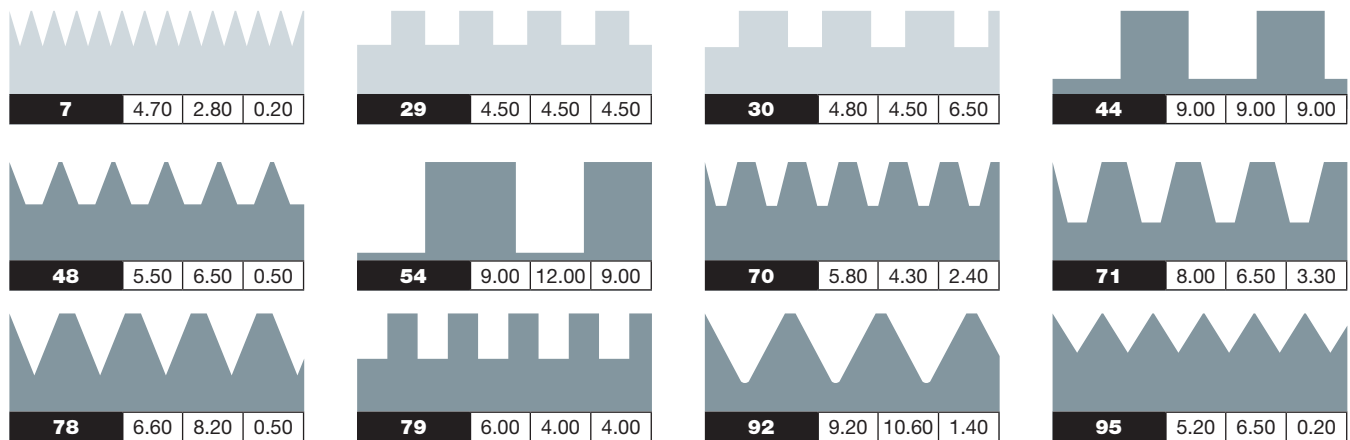

## Pajarito trowel notches (not available as notched blades!)

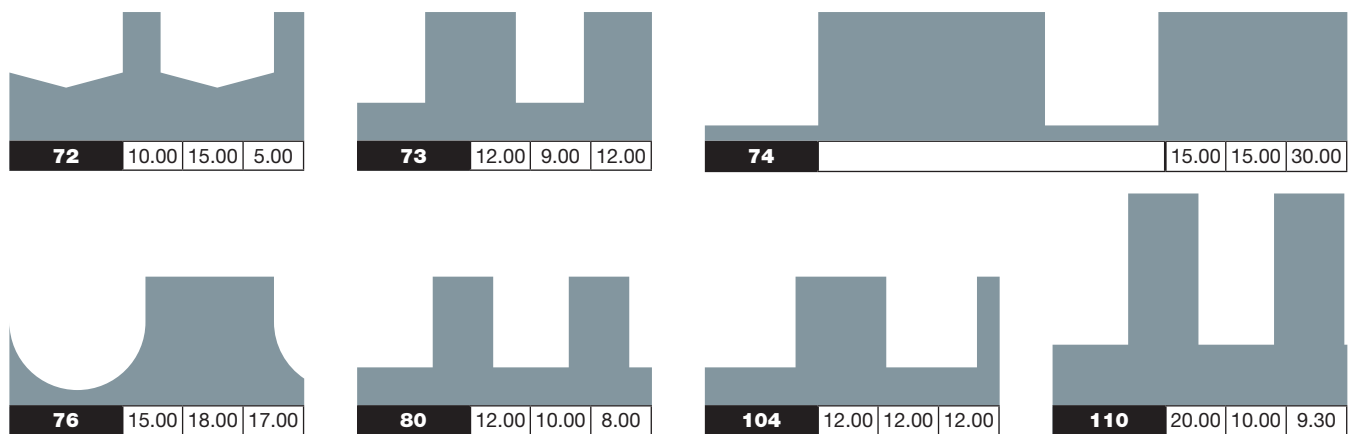

## What do the figures and colours mean?

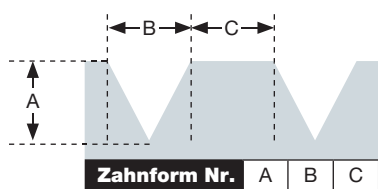

A = notch depth, B = gap width, C = notch width



Notched on both sides.



Notched on one side only.



# Manufactured where we are at home

**Availability and competent consultation, sustainable manufacturing processes, location and perspective, German workmanship and international success: that is the world of Pajarito.**

The location for us is absolutely non-negotiable. In Mettmann, North Rhine-Westphalia, we find ideal conditions for the manufacture and sale of our quality products – and this not just in terms of availability and delivery periods.

In Germany we benefit from motivated staff with an eye for detail and experts with the ideas that

have made Pajarito to what we are today. All our employees work outstandingly well here every day: simply high-class workmanship.

**Tools from Pajarito: produced in Germany and exported to the entire world.**

# Cutting, grinding, scraping, sawing

Highlight product: **PAJARITO-ProfiCut** – a new style of scissors with the straight line.

2



Soft rubber insert for maximum comfort

Permanently sharp through precision ground

Large 4-finger eye ring for maximum control

Straight line for precision

Special facet for cutting to the mark.  
Straight cuts right to the point.

Best of Pajarito! Especially developed for the new generation of fleece wallpaper, in cooperation with 'wallpaper expert' Lothar Steinbrecher, the new stainless scissors line ProfiCut promises extreme precision at work. Due to the newly developed precision blades it cuts even soggy wallpaper cleanly to the point. The eye rings, with rubber inserts for maximum control, accommodate 4 fingers. Made in Germany – Made by Pajarito.

PAJARITO-ProfiCut scissors can be found on 58.



Knives from page 50



Cutters from page 54



Saws from page 61



Paintscrapers on page 68

# Sharp cuts!



## Professional floorlayer tools

Once you have used these, you will never use anything else!

2



| Professional floorlayer knife  |        |  |     |
|--|--------|--|-----|
| Essential for any floorlayer! Ergonomically shaped light-alloy grip panels. For quick and safe working. Blade is additionally affixed by a magnet. Fast blade change through milled screw. |        |  |     |
| Item No  | EAN*   |  | Qty |
| 555  | 016397 |  | 6   |



III Made in Germany  
Made by Pajarito

| Utility knife   |        |  |     |
|---|--------|--|-----|
| Zink die-cast grip panels, grey hammer finish, screw fixes both grip panels and blade, continuously adjustable, with 5 straight blades Item No 57E. |        |  |     |
| Item No   | EAN*   |  | Qty |
| 57  | 505709 |  | 24  |



| Safety knife  |        |  |     |
|---|--------|--|-----|
| Automatic blade retraction, blade magnetically held and adjusted, pusher mechanism for easy open and closing, secure blade reservoir in the handle, includes 3 straight blades. |        |  |     |
| Item No   | EAN*   |  | Qty |
| 570S  | 007265 |  | 10  |



| Utility knife, lacquered   |        |  |     |
|--|--------|--|-----|
| Zink die-cast grip panels, light version, includes 5 straight blades.. |        |  |     |
| Item No  | EAN*   |  | Qty |
| 8575   | 757504 |  | 10  |

Please note: image scale of products may vary.

| Straight blades   |        |     |
|---|--------|-----|
| Cryogenically hardened, polished special steel, 0.65 mm thick, individually wrapped in waxed paper, pack of 12. |        |     |
| Item No   | EAN*   | Qty |
| 57E   | 505785 | 25  |



III Made in Germany  
Made by Pajarito

| Hooked blades                             |        |     |
|---|--------|-----|
| Quality as Item No 57E, but not deep-cut. |        |     |
| Item No                                   | EAN*   | Qty |
| 57H                                       | 505808 | 25  |



III Made in Germany  
Made by Pajarito

| Combination blades  |        |     |
|---|--------|-----|
| Quality as Item No 57E, but pointed (as Item No 57E) and hooked (as Item No 57H) on both sides. |        |     |
| Item No   | EAN*   | Qty |
| 57D   | 505815 | 25  |



III Made in Germany  
Made by Pajarito

| Utility blades  |        |     |
|---|--------|-----|
| Quality as Item No 57E, but additionally edged on both short sides. |        |     |
| Item No   | EAN*   | Qty |
| 57U   | 505822 | 25  |



III Made in Germany  
Made by Pajarito

| Concave blades   |        |     |
|--|--------|-----|
| Quality as Item No 57E, but with concave edge on one side. |        |     |
| Item No  | EAN*   | Qty |
| 57R  | 505839 | 25  |

III Made in Germany  
Made by Pajarito



| Snap-off blades  |        |     |
|--|--------|-----|
| Quality as Item No 57E, but with 4 snap-off sections on both sides (only to be used with utility knives Item Nos 57 and 57K), individually wrapped in waxed paper, pack of 12. |        |     |
| Item No  | EAN*   | Qty |
| 57LG   | 505846 | 10  |

III Made in Germany  
Made by Pajarito

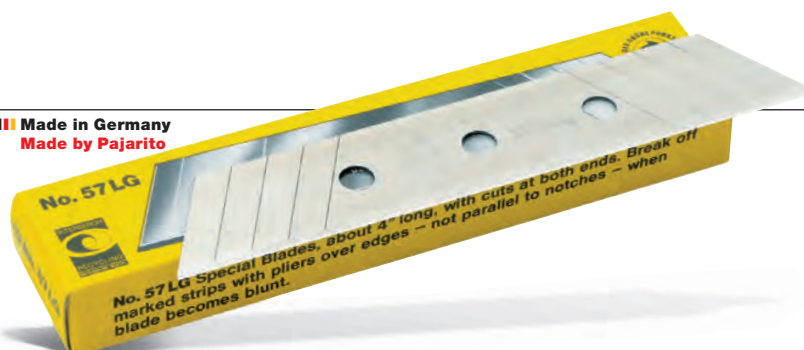

2



|          | <p><b>Straight blades</b><br/>Cryogenically hardened steel, 0.65 mm thick, packed in plastic dispenser, 10 x 10 in carton.</p> <table border="1"> <thead> <tr> <th>Item No</th> <th>EAN*</th> <th>Qty</th> </tr> </thead> <tbody> <tr> <td>570E/K</td> <td>557050</td> <td>10</td> </tr> </tbody> </table> <p><b>Straight blades (no illustration)</b><br/>Quality as Item No 570E/K, but economy pack 100 pcs (20 x 5) in carton.</p> <table border="1"> <tbody> <tr> <td>570E/100</td> <td>557043</td> <td>5</td> </tr> </tbody> </table> | Item No | EAN* | Qty | 570E/K | 557050 | 10 | 570E/100 | 557043 | 5 |
|----------|---|---------|------|-----|--------|--------|----|----------|--------|---|
| Item No  | EAN*  | Qty     |      |     |        |        |    |          |        |   |
| 570E/K   | 557050  | 10      |      |     |        |        |    |          |        |   |
| 570E/100 | 557043  | 5       |      |     |        |        |    |          |        |   |
|          | <p><b>Hook blades</b><br/>Quality as Item No 570E/K, but with deep cut hook.</p> <table border="1"> <thead> <tr> <th>Item No</th> <th>EAN*</th> <th>Qty</th> </tr> </thead> <tbody> <tr> <td>570H/K</td> <td>557104</td> <td>10</td> </tr> </tbody> </table> <p><b>Hook blades (no illustration)</b><br/>Quality as Item No 570H/K, but economy pack.</p> <table border="1"> <tbody> <tr> <td>570H/100</td> <td>557098</td> <td>5</td> </tr> </tbody> </table>  | Item No | EAN* | Qty | 570H/K | 557104 | 10 | 570H/100 | 557098 | 5 |
| Item No  | EAN*  | Qty     |      |     |        |        |    |          |        |   |
| 570H/K   | 557104  | 10      |      |     |        |        |    |          |        |   |
| 570H/100 | 557098  | 5       |      |     |        |        |    |          |        |   |
|          | <p><b>Hook blades, large</b><br/>Quality as Item No 570H/K, but with extra large deep cut hook.</p> <table border="1"> <thead> <tr> <th>Item No</th> <th>EAN*</th> <th>Qty</th> </tr> </thead> <tbody> <tr> <td>570G/K</td> <td>557128</td> <td>10</td> </tr> </tbody> </table>   | Item No | EAN* | Qty | 570G/K | 557128 | 10 |          |        |   |
| Item No  | EAN*  | Qty     |      |     |        |        |    |          |        |   |
| 570G/K   | 557128  | 10      |      |     |        |        |    |          |        |   |
|          | <p><b>Double edge blades</b><br/>Quality as Item No 570E/K, but edged on both sides (as Item No 570E/K) and hook (as Item No 570H/K).</p> <table border="1"> <thead> <tr> <th>Item No</th> <th>EAN*</th> <th>Qty</th> </tr> </thead> <tbody> <tr> <td>570D/K</td> <td>557029</td> <td>10</td> </tr> </tbody> </table>   | Item No | EAN* | Qty | 570D/K | 557029 | 10 |          |        |   |
| Item No  | EAN*  | Qty     |      |     |        |        |    |          |        |   |
| 570D/K   | 557029  | 10      |      |     |        |        |    |          |        |   |
|          | <p><b>Mozart straight blades</b><br/>Cryogenically hardened steel, 0.65 mm thick, packed in 10 x 10 pcs dispenser =100 pcs.</p> <table border="1"> <thead> <tr> <th>Item No</th> <th>EAN*</th> <th>Qty</th> </tr> </thead> <tbody> <tr> <td>575E</td> <td>621195</td> <td>10</td> </tr> </tbody> </table>   | Item No | EAN* | Qty | 575E   | 621195 | 10 |          |        |   |
| Item No  | EAN*  | Qty     |      |     |        |        |    |          |        |   |
| 575E     | 621195  | 10      |      |     |        |        |    |          |        |   |
|          | <p><b>Mozart hook blades</b><br/>Cryogenically hardened steel, 0.65 mm thick, packed in 10 x 10 dispenser =100 pcs. in carton.</p> <table border="1"> <thead> <tr> <th>Item No</th> <th>EAN*</th> <th>Qty</th> </tr> </thead> <tbody> <tr> <td>575H</td> <td>621294</td> <td>10</td> </tr> </tbody> </table>  | Item No | EAN* | Qty | 575H   | 621294 | 10 |          |        |   |
| Item No  | EAN*  | Qty     |      |     |        |        |    |          |        |   |
| 575H     | 621294  | 10      |      |     |        |        |    |          |        |   |
|          | <p><b>Mozart hook blades, large</b><br/>Cryogenically hardened steel, 0.65 mm thick, packed in 10 x 10 pcs dispenser =100 pcs.</p> <table border="1"> <thead> <tr> <th>Item No</th> <th>EAN*</th> <th>Qty</th> </tr> </thead> <tbody> <tr> <td>575G</td> <td>670223</td> <td>10</td> </tr> </tbody> </table>  | Item No | EAN* | Qty | 575G   | 670223 | 10 |          |        |   |
| Item No  | EAN*  | Qty     |      |     |        |        |    |          |        |   |
| 575G     | 670223  | 10      |      |     |        |        |    |          |        |   |
|          | <p><b>Straight blades</b><br/>Fitting all standard utility knives, in 10 x 10 pcs dispenser =100 pcs.</p> <table border="1"> <thead> <tr> <th>Item No</th> <th>EAN*</th> <th>Qty</th> </tr> </thead> <tbody> <tr> <td>8057E</td> <td>705741</td> <td>10</td> </tr> </tbody> </table>  | Item No | EAN* | Qty | 8057E  | 705741 | 10 |          |        |   |
| Item No  | EAN*  | Qty     |      |     |        |        |    |          |        |   |
| 8057E    | 705741  | 10      |      |     |        |        |    |          |        |   |
|          | <p><b>Hook blades</b><br/>Fitting all standard utility knives, in 10 x 10 pcs dispenser =100 pcs.</p> <table border="1"> <thead> <tr> <th>Item No</th> <th>EAN*</th> <th>Qty</th> </tr> </thead> <tbody> <tr> <td>8057H</td> <td>705765</td> <td>10</td> </tr> </tbody> </table>  | Item No | EAN* | Qty | 8057H  | 705765 | 10 |          |        |   |
| Item No  | EAN*  | Qty     |      |     |        |        |    |          |        |   |
| 8057H    | 705765  | 10      |      |     |        |        |    |          |        |   |

Please note: image scale of products may vary.

| <b>Heavy duty blade, 3-hole</b>  |        |  |     |
|--|--------|--|-----|
| Cryogenically hardened, polished steel, 0.15 mm thick, with rounded side edges, individually wrapped in waxed paper, pack of 10. |        |  |     |
| Item No  | EAN*   |  | Qty |
| 155E   | 501558 |  | 10  |

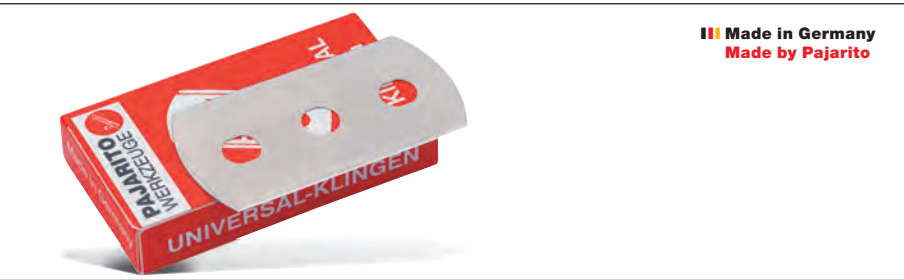

| <b>Industrial heavy duty blade, 3-hole</b>  |        |  |     |
|---|--------|--|-----|
| Polished steel, 0.3 mm thick, with rounded side edges, individually wrapped in waxed paper, pack of 10. |        |  |     |
| Item No   | EAN*   |  | Qty |
| 665E  | 566519 |  | 10  |
| <b>Industrial blade, 3-hole (no illustration)</b>   |        |  |     |
| As Item No 665E, but with straight side edges.  |        |  |     |
| 665EG   | 566526 |  | 10  |



| <b>Utility knife</b>                            |        |  |     |
|---|--------|--|-----|
| Fixed, hardened, polished blade, wooden handle. |        |  |     |
| Item No   | EAN*   |  | Qty |
| 19A   | 501916 |  | 12  |



| <b>Weld seam groover</b>  |        |  |     |
|---|--------|--|-----|
| Plastic handle with chuck and exchangeable round blade Item No 658E/1 for shaving off weld-rods in coverings. |        |  |     |
| Item No   | EAN*   |  | Qty |
| 658   | 565802 |  | 1   |
| <b>Spare blade</b>  |        |  |     |
| Size 1, 2, 3 or 4 in PVC-pouch with 2 each.   |        |  |     |
| 658E/1  | 565819 |  | 20  |
| 658E/2  | 565826 |  | 20  |
| 658E/3  | 565833 |  | 20  |
| 658E/4  | 565840 |  | 20  |

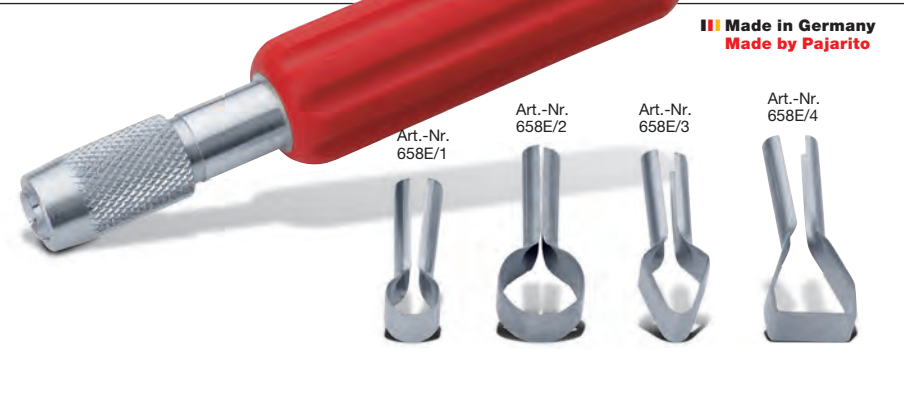

| <b>Floor covering knife</b>  |        |  |     |
|------------------------------|--------|--|-----|
| <b>Handle, without blade</b> |        |  |     |
| Item No                      | EAN*   |  | Qty |
| 349A                         | 534914 |  | 6   |
| <b>Spare blades</b>          |        |  |     |
| 349/1                        | 534921 |  | 10  |
| 349/2                        | 534938 |  | 10  |
| 349/4                        | 534952 |  | 10  |



# Cutter 18 mm

2



**NT-Cutter L-2000RP, auto-lock**  
Robust metal barrel, metal liner, blade cartridge for 6 blades, automatic lock.  
Includes 2 NT-blades.

| Item No | EAN*   | Dimensions | Qty |
|---------|--------|------------|-----|
| 5719    | 502043 | 18 mm      | 10  |



**NT-Cutter L-500G**  
Robust metal barrel, metal liner, blade cartridge for 6 blades, screw lock.  
Includes 1 NT-blade.

| Item No | EAN*   | Dimensions | Qty |
|---------|--------|------------|-----|
| 5720    | 500155 | 18 mm      | 10  |



**NT-Cutter L-500GR, auto-lock**  
As Item No 5720, but with automatic lock.

| Item No | EAN*   | Dimensions | Qty |
|---------|--------|------------|-----|
| 5725    | 013815 | 18 mm      | 10  |



**NT-Cutter L-700RP, auto-lock**  
Plastic barrel, metal liner, blade cartridge for up to 6 blades, automatic lock.  
Includes 2 NT-blades.

| Item No | EAN*   | Dimensions | Qty |
|---------|--------|------------|-----|
| 5721    | 690603 | 18 mm      | 10  |



**NT-Cutter L-500**  
Plastic barrel, metal liner, screw lock.  
Includes 3 NT-blades.

| Item No | EAN*   | Dimensions | Qty |
|---------|--------|------------|-----|
| 5717    | 501947 | 18 mm      | 10  |



**Snap-off knife**  
Sturdy plastic barrel, metal liner, screw lock, finger lock, 0.5 mm thick snap-off blade.  
Includes 3 blades.

| Item No | EAN*   | Dimensions | Qty |
|---------|--------|------------|-----|
| 5715    | 457299 | 18 mm      | 10  |



**Snap-off knife, auto-lock**  
Impact proof plastic barrel, sturdy, metal liner, automatic lock.  
Includes: knife loaded with 18 mm snap-off blade and 2 spare blades in the barrel reservoir.

| Item No | EAN*   | Dimensions | Qty |
|---------|--------|------------|-----|
| 87170   | 007012 | 18 mm      | 10  |

Please note: image scale of products may vary.

# Top service since 1923

**Contact and trust. Advice and sales. Training, service and representation with long standing customer relationships. Pajarito: since 1923.**

## Snap-off knife, auto-lock

Plastic barrel, metal liner, blade cartridge for 2 blades, automatic lock. Securely locking blade release withstands compression/tension load of 200 N (20 kg). Includes 3 blades.

| Item No | EAN*   | Dimensions | Qty |
|---------|--------|------------|-----|
| 57170   | 571704 | 18 mm      | 10  |



## Snap-off knife

Plastic barrel, metal liner, screw lock. Includes 3 snap-off blades, 0.5 mm thick.

| Item No | EAN*   | Dimensions | Qty |
|---------|--------|------------|-----|
| 5713    | 457282 | 18 mm      | 12  |

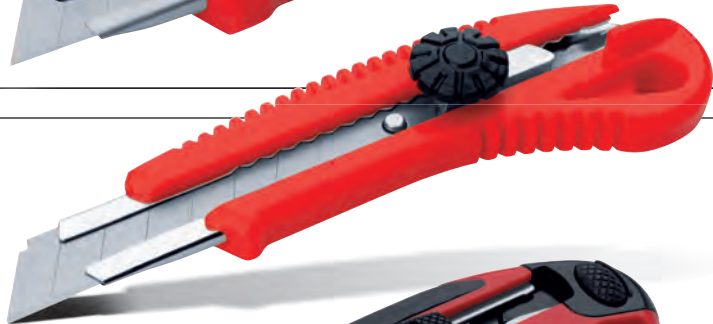

## Snap-off knife, auto-lock

2-component plastic barrel, metal liner, automatic lock. Blade-feed from cartridge containing 3 blades. Includes 4 blades in total.

| Item No | EAN*   | Dimensions | Qty |
|---------|--------|------------|-----|
| 8719    | 002208 | 18 mm      | 12  |



## Snap-off knife

Plastic barrel, metal liner, screw lock. Includes 3 blades.

| Item No | EAN*   | Dimensions | Qty |
|---------|--------|------------|-----|
| 8717    | 691303 | 18 mm      | 12  |



## Snap-off knife

Plastic barrel, metal liner, lock. Includes 1 snap-off blade, 0.5 mm thick.

| Item No | EAN*   | Dimensions | Qty |
|---------|--------|------------|-----|
| 8712    | 630401 | 18 mm      | 24  |



## Snap-off knife

Plastic barrel, lock. Includes 1 snap-off blade, 0.5 mm thick. Economy version.

| Item No | EAN*   | Dimensions | Qty |
|---------|--------|------------|-----|
| 8711    | 457145 | 18 mm      | 48  |

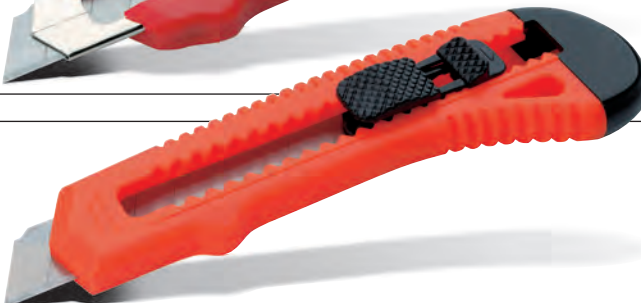

# Cutter 9 mm

2



**NT-Cutter A-1000RP, auto-lock**  
Sturdy metal barrel, metal liner, blade cartridge with 2 replacement blades.

| Item No | EAN*   | Dimensions | Qty |
|---------|--------|------------|-----|
| 5724    | 004493 | 9 mm       | 10  |



**NT-Cutter A-300GR, auto-lock**  
Metal barrel with slide-lock mechanism, auto-lock.  
Includes 1 NT-blade.

| Item No | EAN*   | Dimensions | Qty |
|---------|--------|------------|-----|
| 5728    | 024897 | 9 mm       | 20  |



**NT-Cutter K-200RP, auto-lock**  
Metal barrel with slide-lock mechanism, auto-lock.  
Includes 1 NT-blade.

| Item No | EAN*   | Dimensions | Qty |
|---------|--------|------------|-----|
| 5718    | 501961 | 9 mm       | 20  |



**Snap-off knife**  
Plastic barrel, metal liner, lock.  
Includes 1 snap-off blade, 0.45 mm thick.

| Item No | EAN*   | Dimensions | Qty |
|---------|--------|------------|-----|
| 5709    | 557302 | 9 mm       | 24  |



**Snap-off knife**  
Plastic barrel, lock.  
Includes 1 snap-off blade, 0.45 mm thick.  
Economy version.

| Item No | EAN*   | Dimensions | Qty |
|---------|--------|------------|-----|
| 8710    | 457107 | 9 mm       | 60  |

# Cutter-blades 18 mm



**Made in Germany  
Made by Pajarito**

**Snap-off blades**  
Hardened, polished steel, 18 mm wide, 0.5 mm thick, 7 snap-off sections, wrapped in waxed paper, 5 blades per PVC-packet (10 packets per tear-off package).

| Item No | EAN*   | Dimensions | Qty |
|---------|--------|------------|-----|
| 5711E   | 557258 | 18 mm      | 10  |



**Made in Germany  
Made by Pajarito**

**Snap-off blades**  
As Item No 5711E, but with 10 pcs plastic dispenser and 20 x 10 pcs in a carton.

| Item No | EAN*   | Dimensions | Qty |
|---------|--------|------------|-----|
| 5711EK  | 557265 | 18 mm      | 20  |

Please note: image scale of products may vary.

**NT Replacement blades, BL10-P**

0.45 mm thick, 18 mm wide, 7 snap-off sections, plastic box of 10.

| Item No | EAN*   | Dimensions | Qty |
|---------|--------|------------|-----|
| 5717E   | 501954 | 18 mm      | 20  |

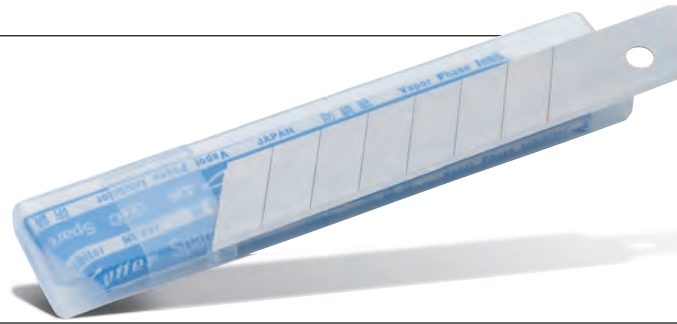
**Snap-off blades**

Hardened, polished steel, 0.5 mm thick, 7 snap-off sections, plastic box of 10. Standard version.

| Item No | EAN*   | Dimensions | Qty |
|---------|--------|------------|-----|
| 8711E   | 557272 | 18 mm      | 20  |

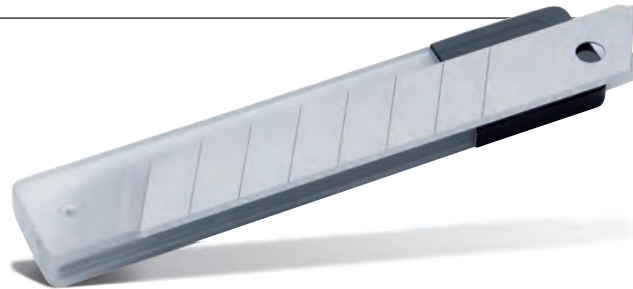

# Cutter blades 9 mm

**Snap-off blades**

Hardened, polished steel, 0.5 mm thick, 12 snap-off sections, wrapped in waxed paper, pack of 10 in PVC packet (10 packets in tear-off package).

| Item No | EAN*   | Dimensions | Qty |
|---------|--------|------------|-----|
| 5710E   | 557234 | 9 mm       | 10  |

III Made in Germany  
Made by Pajarito

**Snap-off blades**

Quality and version as Item No 5710E, but with 10 pcs in plastic dispenser, 20 x 10 pcs in a carton.

| Item No | EAN*   | Dimensions | Qty |
|---------|--------|------------|-----|
| 5710EK  | 557241 | 9 mm       | 20  |

III Made in Germany  
Made by Pajarito

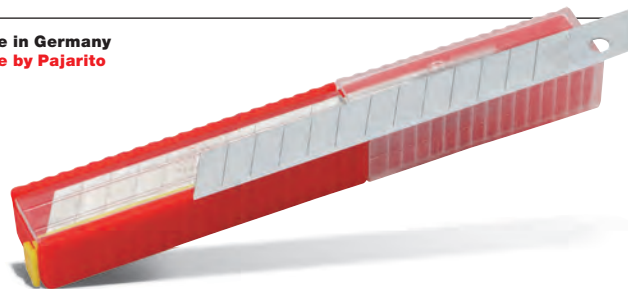
**NT-Spare blades BA-10P**

0,40 mm thick, 12 snap-off sections, pack of 10 in plastic box.

| Item No | EAN*   | Dimensions | Qty |
|---------|--------|------------|-----|
| 5718E   | 501978 | 9 mm       | 20  |

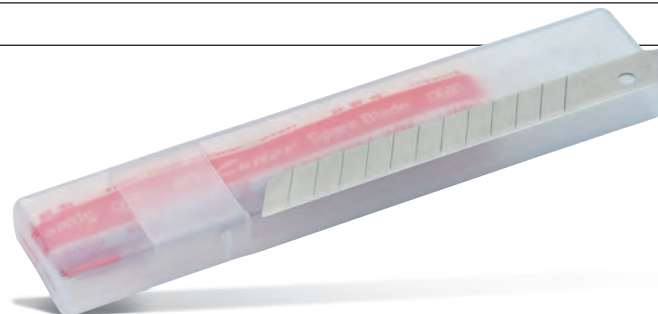
**Snap-off blades**

Hardened, polished steel, 0.5 mm thick, 12 snap-off sections, plastic box of 10. Standard version.

| Item No | EAN*   | Dimensions | Qty |
|---------|--------|------------|-----|
| 8710E   | 757108 | 9 mm       | 10  |

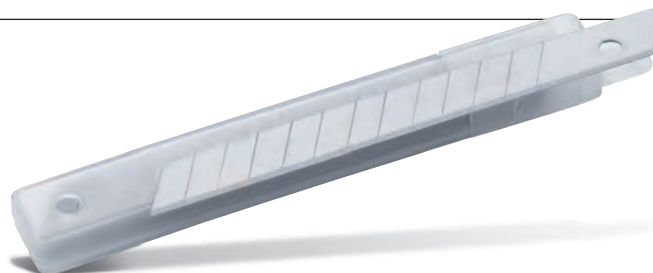

# Wallpaper scissors ProfiCut

## Wallpaper scissors Profi Cut

Stainless wallpaping and paper scissors with fibreglass-reinforced break-resistant ergonomically moulded plastic handles and comfortable soft rubber inserts. Extra large four-finger eye for maximum control, stainless, heat-treated special steel for noticeably longer life, straight lines suitable for sliding section. Traditionally executed hollow ground and finely polished blades on precision grinding machines of the latest generation. Bilateral facet tips for millimetre-precise marking and cutting. Adjustable conical, stainless steel special screw.

| Item No | EAN*   | Dimensions | Qty |
|---------|--------|------------|-----|
| 01500   | 021735 | 280 mm     | 6   |

**Woodchip wallpaper scissors, stainless**  
Especially suited for woodchip, finely serrated on one side. Top quality: every pair of scissors checked individually and test-cut.

|        |        |        |   |
|--------|--------|--------|---|
| 01500R | 021742 | 280 mm | 6 |
|--------|--------|--------|---|

Made in Germany  
Made by Pajarito



Permanently sharp through precision grinding.

Soft rubber insert for maximum comfort.

Large 4-finger eye ring for maximum control.

Straight line for precision.

Special facet for cutting to the mark. Straight cuts right to the point.



reddot design award

2





**Wallpaper scissors, stainless**  
Hollow stamped handles, mirror finish, stainless special steel, moulded-on plastic rings.

| Item No | EAN*   | Dimensions | Qty |
|---------|--------|------------|-----|
| 01535   | 515395 | 260 mm     | 12  |





**Left handed scissors, stainless**  
Hardened stainless steel, with impact resistant ABS-plastic rings.

| Item No | EAN*   | Dimensions | Qty |
|---------|--------|------------|-----|
| 01536L  | 007098 | 260 mm     | 6   |





**Wallpaper scissors, stainless**  
Molded-on plastic rings.

| Item No | EAN*   | Dimensions | Qty |
|---------|--------|------------|-----|
| 8976    | 641575 | 300 mm     | 6   |





**Wallpaper scissors, stainless**  
Molded-on plastic rings. Standard version.

| Item No | EAN*   | Dimensions | Qty |
|---------|--------|------------|-----|
| 8153    | 415305 | 280 mm     | 12  |

Please note: image scale of products may vary.

**Textile scissors, stainless**

Special scissors, stainless, for decorative wallpapers and felts, extra slanted cutting edges, mirror finish in and out, plastic rings with soft component.

Made in Germany  
Made by Pajarito



| Item No | EAN*   | Dimensions | Qty |
|---------|--------|------------|-----|
| 075R/23 | 027430 | 200 mm     | 6   |

**Scissors holster**

Plastic, with practical clip for hooking on belt, smock, overall or folding-rule pocket.

Made in Germany  
Made by Pajarito



| Item No | EAN*   | Dimensions | Qty |
|---------|--------|------------|-----|
| 799     | 507994 |            | 6   |

**Wallpaper scissors**

Forged, polished, teflonised steel, plastic covered rings.

| Item No | EAN*   | Dimensions | Qty |
|---------|--------|------------|-----|
| 2075/25 | 520757 | 250 mm     | 6   |

**Woodchip wallpaper scissors**

As Item No 2075/25, but one cutting edge finely serrated.

|          |        |        |   |
|----------|--------|--------|---|
| 2075R/25 | 520771 | 250 mm | 6 |
|----------|--------|--------|---|



**Carpet scissors, stainless**

Heavy-duty, polished, stainless special steel, moulded-on soft rings.

Made in Germany  
Made by Pajarito



| Item No | EAN*   | Dimensions | Qty |
|---------|--------|------------|-----|
| 074/26  | 503736 | 260 mm     | 6   |

**Carpet scissors serrated, stainless**

As Item No 074/26, but one cutting edge finely serrated.

|         |        |        |   |
|---------|--------|--------|---|
| 074R/26 | 503750 | 260 mm | 6 |
|---------|--------|--------|---|

**Linoleum scissors**

Forged steel, fine polished blades, black enamel handles and rings, high screw

Made in Germany  
Made by Pajarito



| Item No | EAN*   | Dimensions | Qty |
|---------|--------|------------|-----|
| 74/21   | 574217 | 210 mm     | 6   |
| 74/26   | 574262 | 265 mm     | 6   |
| 74/30   | 574309 | 300 mm     | 6   |

**Duckbill nap shears**

Nickel-plated forged steel, with bent-up, soft-plastic coated bows.

| Item No | EAN*   | Dimensions | Qty |
|---------|--------|------------|-----|
| 360     | 536000 | 185 mm     | 6   |



# Mitre & special shears

2



| Mitre cutting shears  |        |            |     |
|---|--------|------------|-----|
| 45° locations and markings for cuts of 15°, 30° and 90°. Suitable for mitre-cuts on tile end strips, wooden and decor strips. |        |            |     |
| Item No   | EAN*   | Dimensions | Qty |
| 159   | 501596 | 200 mm     | 1   |
| Spare blade (no illustration)   |        |            |     |
| 159M  | 500056 |            | 1   |
| Spare mitre plate (no illustration)   |        |            |     |
| 159G  | 500049 |            | 1   |



| Baseboard shears   |        |            |     |
|--|--------|------------|-----|
| For skirting boards, with lever transmission and 90° stop plate, cutting length 85 mm. |        |            |     |
| Item No  | EAN*   | Dimensions | Qty |
| 1590   | 681908 | 225 mm     | 1   |
| Spare blade (no illustration)  |        |            |     |
| 1590M  | 000815 |            | 1   |
| Spare stop plate 45° (no illustration)   |        |            |     |
| 1590G  | 002086 |            | 1   |
| Spare stop plate 90° (no illustration)   |        |            |     |
| 1590A  | 000808 |            | 1   |



| Mitre shears with straight blade   |        |              |     |
|--|--------|--------------|-----|
| 45° locations and markings, suitable for mitre-cuts in rubber lips with fabric reinforced tape, plastic tile decor strips or plaster stop beads. |        |              |     |
| Item No  | EAN*   | Dimensions   | Qty |
| 159S   | 017134 | 220 mm       | 1   |
| 159SE  | 027300 | Spare blades | 4   |



| Special snips for leather and rubber  |        |            |     |
|---|--------|------------|-----|
| Forged steel, one serrated cutting-edge, lacquered handles, polished head, with spring-action and safety latch. |        |            |     |
| Item No   | EAN*   | Dimensions | Qty |
| 174   | 501749 | 250 mm     | 1   |



| Zinc-sheet and hole cutting snips            |        |            |     |
|--|--------|------------|-----|
| Forged steel, bright edges, for right cuts.. |        |            |     |
| Item No                                      | EAN*   | Dimensions | Qty |
| 760  | 576006 | 250 mm     | 6   |



| Leverage metal snips  |        |            |     |
|---|--------|------------|-----|
| Hardened, black lacquered steel, leverage assistance, cutting thickness up to 1.5 mm sheet-metal. |        |            |     |
| Item No   | EAN*   | Dimensions | Qty |
| 764   | 503583 | 225 mm     | 1   |

Please note: image scale of products may vary.

# Saws

## Moulding saw, stainless

Hardened, polished spring band steel blade, 0.6 mm thick, reinforced back, wooden handle.



| Item No | EAN*   | Dimensions  | Qty |
|---------|--------|-------------|-----|
| 260/30  | 526025 | 300 x 80 mm | 6   |

## Sash saw, stainless

Hardened, polished spring band steel blade, 0.7 mm thick, induction hardened teeth, closed plastic handle, with rounded blade point also toothed.

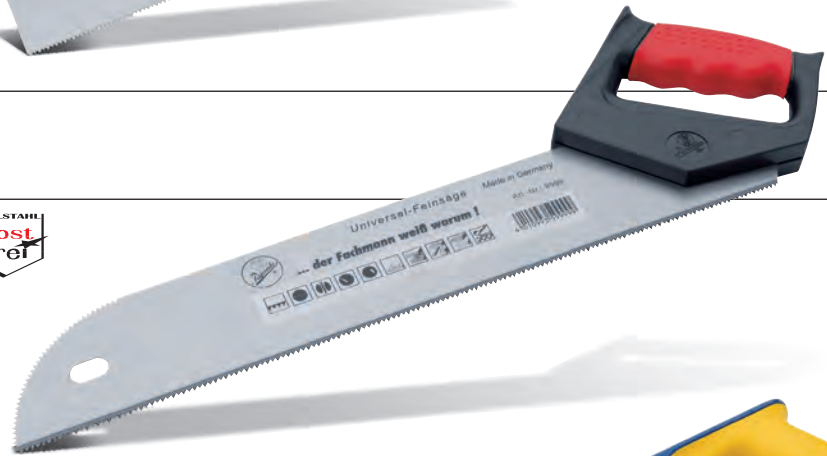

| Item No | EAN*   | Dimensions  | Qty |
|---------|--------|-------------|-----|
| 9999    | 599999 | 400 x 70 mm | 6   |
| 9999A   | 599982 | 320 x 70 mm | 6   |

## Mitre saw

Hardened band steel, 1 mm thick, crosswise putted, induction herdenend teeth, closed 2-component plastic handle with 45° and 90° angle flange. Delivered with magnet-held plastic blade protector.



| Item No | EAN*   | Dimensions | Qty |
|---------|--------|------------|-----|
| 50307   | 000013 | 500 mm     | 4   |

## Japanese saw, pistol handle

Standard version, 265 mm blade length, standard toothing, for dry wood, plywood, plasterboard, plastics (excellent on Melamin), handle from impact resistant ABS-plastic.



| Item No | EAN*   | Dimensions  | Qty |
|---------|--------|-------------|-----|
| 9997    | 017035 | 265 mm      | 1   |
| 9997E   | 003564 | Spare blade | 1   |

## Japanese saw, straight handle

As Item No 9997, but with long, straight handle from impact resistant ABS-plastic and elastomer for better grip. The long handle allows for two-handed work.



| Item No | EAN*   | Dimensions  | Qty |
|---------|--------|-------------|-----|
| 9998    | 017028 | 265 mm      | 1   |
| 9997E   | 003564 | Spare blade | 1   |

2



| Hand saw   |        |  |     |
|--|--------|--|-----|
| Closed plastic handle, 440 mm long fine-toothed blade. |        |  |     |
| Item No  | EAN*   |  | Qty |
| 8266   | 702665 |  | 1   |



| Adjustable hacksaw   |        |            |     |
|--|--------|------------|-----|
| Adjustable handle, nickel-plated bow, exchangeable hack-saw blade. |        |            |     |
| Item No  | EAN*   | Dimensions | Qty |
| 414  | 541400 | 140 mm     | 12  |
| Spare blades for wood (no illustration)                            |        |            |     |
| 414E/H   | 541424 | 140 mm     | 12  |
| Spare blades for metal (no illustration)                           |        |            |     |
| 414E/M   | 541431 | 140 mm     | 12  |



| Household saw                                 |        |            |     |
|---|--------|------------|-----|
| Blade for wood and plastic. Standard version. |        |            |     |
| Item No                                       | EAN*   | Dimensions | Qty |
| 8414  | 441403 | 140 mm     | 12  |
| Spare blades, 12 x 5 pcs (no illustration)    |        |            |     |
| 8414E   | 441427 | 140 mm     | 1   |



| Hacksaw   |        |            |     |
|---|--------|------------|-----|
| Oval, nickel-plated tubular steel, metal cutting blade. |        |            |     |
| Item No   | EAN*   | Dimensions | Qty |
| 8415  | 441502 | 300 mm     | 6   |
| Spare blades (no illustration)                          |        |            |     |
| 8415E   | 741510 | 300 mm     | 12  |



■ ■ ■ Made in Germany  
 Made by Pajarito

EDELSTAHL  
Rost  
 frei

| Saw for rigid expanded PU, stainless  |        |              |     |
|---|--------|--------------|-----|
| Hardened, stainless steel blade, 0.7 mm thick, sturdy plastic handle, specially toothed blade for cutting sheet and profiled rigid PU foam. |        |              |     |
| Item No   | EAN*   | Dimensions   | Qty |
| 423   | 104230 | 500 x 100 mm | 1   |



| Saw for rigid expanded PU   |        |            |     |
|---|--------|------------|-----|
| Hardened, steel blade, 0.7 mm thick, sturdy plastic handle, specially toothed blade for cutting sheet and profiled rigid PU foam. |        |            |     |
| Item No   | EAN*   | Dimensions | Qty |
| 8423  | 620105 | 400 mm     | 1   |

Please note: image scale of products may vary.

# Mitre boxes

| Profile mitre box  |        |                    |     |
|--|--------|--------------------|-----|
| Double/walled plastic, sawing guides for 22,5° / 45° / 90°, 2 adjustable locking buttons in the base plate, cutting width up to 150 mm, cutting heights up to 120 mm. Dimensions: total length x cutting width x cutting height. |        |                    |     |
| Item No  | EAN*   | Total L x W x H    | Qty |
| 50309  | 000006 | 370 x 220 x 140 mm | 1   |



| Mitre box   |        |                  |     |
|---|--------|------------------|-----|
| Birch-plywood, side walls of Item No 262 are glued and pinned, Item No 262S glued and screwed. Dimensions: total length x cutting width x cutting height. |        |                  |     |
| Item No   | EAN*   | Total L x W x H  | Qty |
| 262   | 526209 | 300 x 53 x 40 mm | 3   |
| 262S  | 526261 | 300 x 70 x 70 mm | 2   |



Made in Germany  
Made by Pajarito



# Top-Set for pros

| Professional mitre box   |        |              |     |
|--|--------|--------------|-----|
| Cutting mouldings and chair rails from polystyrene, PUR, polyurethane, coated facade mouldings and wooden strips. Made for strong laminated wood, degree scale with 9 adjustable angles. |        |              |     |
| <b>Set content:</b> 1 mitre box, 1 saw for PS, 1 saw for PU, 1 delay rule, 1 graduated metal rule.   |        |              |     |
| Table-length 475 mm, cutting-width 180 mm, cutting-height 175 mm, total-width 200 mm, total-height 230 mm.   |        |              |     |
| Item No  | EAN*   | Dimensions   | Qty |
| 258  | 016588 | 230 x 250 mm | 1   |
| 258E/A   | 023777 | 500 mm       | 1   |
| 258E/B   | 023784 | 500 x 100 mm | 1   |

Made in Germany  
Made by Pajarito



# It's all a matter of habit!

For us good work is a tradition: smooth operations, short delivery times and the know-how of our qualified colleagues. Pajarito: Always a good experience. Since 1923.

 **Made in Germany**

2

## Grinding tools & abrasives



| Sanding block |        |                  |     |
|---------------|--------|------------------|-----|
| Pressed cork. |        |                  |     |
| Item No       | EAN*   | Dimensions       | Qty |
| 8087B         | 708735 | 118 x 59 x 35 mm | 12  |



| Rubber sanding block             |        |                  |     |
|----------------------------------|--------|------------------|-----|
| Solid rubber with inserted pins. |        |                  |     |
| Item No                          | EAN*   | Dimensions       | Qty |
| 87                               | 508700 | 120 x 70 x 35 mm | 6   |



| Sanding block                       |        |                  |     |
|-------------------------------------|--------|------------------|-----|
| Black, soft PVC with inserted pins. |        |                  |     |
| Item No                             | EAN*   | Dimensions       | Qty |
| 8087A                               | 708711 | 130 x 70 x 30 mm | 12  |



| Hand sander   |        |              |     |
|---|--------|--------------|-----|
| Plastic, bonded-on sanding sponge pad, zinc-plated, spring loaded clamps. |        |              |     |
| Item No   | EAN*   | Dimensions   | Qty |
| 85A   | 500858 | 105 x 210 mm | 10  |
| 85B   | 500865 | 85 x 165 mm  | 10  |

Please note: image scale of products may vary.

**Sanding sponge**

Abrasive paper and sanding block in one, for wet and dry sanding. Grain: MF = medium/fine, MG = medium/coarse.

| Item No | EAN*   | Dimensions       | Qty |
|---------|--------|------------------|-----|
| 8191MF  | 693604 | 100 x 70 x 30 mm | 24  |
| 8191MG  | 693505 | 100 x 70 x 30 mm | 24  |



**Pole sander**

Large, light alloy backing plate, bonded-on 5mm thick open cell foam pad, clamps, steel swivel joint, threaded, wooden broom stick, 1200 mm long, included.

| Item No | EAN*   | Dimensions  | Qty |
|---------|--------|-------------|-----|
| 854     | 585404 | 240 x 85 mm | 1   |



**Pole sander**

Large, impact-resistant plastic backing plate, bonded-on 5 mm thick open cell foam pad, steel clamps, plastic swivel joint with nozzle to insert a pole. Standard version.

| Item No | EAN*   | Dimensions   | Qty |
|---------|--------|--------------|-----|
| 8854    | 666363 | 210 x 105 mm | 2   |



**Hand sander**

Backing plate, 5 mm thick, and handle from expanded plastic, bonded-on 10 mm thick open cell foam pad, plastic clamping brackets.

| Item No | EAN*   | Dimensions  | Qty |
|---------|--------|-------------|-----|
| 856     | 508564 | 235 x 80 mm | 2   |



**Sanding screens**

Used with hand sander Item Nos 854 and 8854, 290 x 115 mm.

| Item No  | EAN*   | Grain | Qty |
|----------|--------|-------|-----|
| 854E/60  | 666561 | 60    | 25  |
| 854E/100 | 585411 | 100   | 25  |
| 854E/180 | 666660 | 180   | 25  |

**Sanding screens**

Used for hand sander Item No 856, 285 x 93 mm.

|      |        |     |    |
|------|--------|-----|----|
| 856E | 585442 | 100 | 10 |
|------|--------|-----|----|



**Steel wool**

In rolls of 200 g, graded from 000 (ultra-fine) to 5 (coarse).

| Item No | EAN*   | Qty                |
|---------|--------|--------------------|
| 370/000 | 537007 | 24                 |
| 370/00  | 537014 | 24                 |
| 370/0   | 537021 | 24                 |
| 370/1   | 537038 | 24                 |
| 370/2   | 537045 | 24                 |
| 370/3   | 537052 | 24                 |
| 370/4   | 537069 | 24                 |
| 370/5   | 537076 | 24                 |
| 371/00  | 003571 | NEW: steel pads 12 |



**Edger**

Cast aluminium, plastic handle, replaceable blade. Use with plasterboard, breeze blocks, wood, fibre-board, and more.

| Item No | EAN*   | Dimensions  | Qty |
|---------|--------|-------------|-----|
| 830A    | 483007 | 250 x 42 mm | 2   |

**Spare blade**

|        |        |             |    |
|--------|--------|-------------|----|
| 830A/E | 483014 | 250 x 42 mm | 10 |
|--------|--------|-------------|----|



III Made in Germany  
Made by Pajarito



**Wall scraper**

Two exchangeable, hardened, polished spring steel blades, 0.3 mm thick, rounded corners, shaped wooden handle, nickel-plated bolts with knurled brass nuts.

| Item No                               | EAN*   | Dimensions | Qty |
|---------------------------------------|--------|------------|-----|
| <b>852/20</b>                         | 585206 | 200 mm     | 6   |
| <b>852/30</b>                         | 585213 | 300 mm     | 6   |
| <b>Spare blades (no illustration)</b> |        |            |     |
| <b>852E/20</b>                        | 585220 | 200 mm     | 6   |
| <b>852E/30</b>                        | 585237 | 300 mm     | 6   |

2

III Made in Germany  
Made by Pajarito



**Wall and ceiling scraper**

Holder from light-alloy, 3 nickel-plated bolts with wing nuts, exchangeable hardened, polished spring band steel blade, 0.3 mm thick, spring band steel comb plate, wooden pole, 650 mm long, included.

| Item No                               | EAN*   | Dimensions | Qty |
|---------------------------------------|--------|------------|-----|
| <b>851</b>                            | 585107 | 275 mm     | 2   |
| <b>Spare blades (no illustration)</b> |        |            |     |
| <b>851E/0,3</b>                       | 585114 | 0.3 mm     | 2   |
| <b>851E/1,2</b>                       | 585121 | 1.2 mm     | 2   |
| <b>Comb plate (no illustration)</b>   |        |            |     |
| Polished spring band steel.           |        |            |     |
| <b>851K</b>                           | 585138 | 0.8 mm     | 1   |

# Scraping tools

III Made in Germany  
Made by Pajarito



**Scraper handle**

Round bar steel, 8 mm diameter, round nut with 9 mm male square, washer, hex-nut, cross-riveted wooden handle.

| Item No     | EAN*   | Dimensions | Qty |
|-------------|--------|------------|-----|
| <b>131A</b> | 113157 | 250 mm     | 6   |

**Triangular blade**

Hardened, special steel, 3 mm thick, 9 mm square hole, bevelled on all sides, triangular.

| Item No       | EAN*   | Dimensions | Qty |
|---------------|--------|------------|-----|
| <b>131E/6</b> | 113133 | 60 mm      | 1   |
| <b>131E/8</b> | 113140 | 80 mm      | 1   |

**Drop shaped blade**

Quality as Item No 131E, but drop shaped.

| Item No       | EAN*   | Dimensions | Qty |
|---------------|--------|------------|-----|
| <b>132E/6</b> | 113270 | 45 x 60 mm | 1   |

**All-purpose blade**

Quality as Item No 131E, but with one straight, two convex contours and three concave contours.

| Item No       | EAN*   | Dimensions | Qty |
|---------------|--------|------------|-----|
| <b>133E/6</b> | 113379 | 50 x 60 mm | 1   |

**Rectangular blade**

Quality as Item No 131E, but rectangular, one short side rounded.

| Item No     | EAN*   | Dimensions | Qty |
|-------------|--------|------------|-----|
| <b>137E</b> | 113720 | 28 x 70 mm | 1   |

Please note: image scale of products may vary.

**Scraper handle**

Round bar steel, 8 mm diameter, washer, hex-nut, cross-riveted wooden handle. Standard version.

III Made in Germany  
Made by Pajarito

| Item No | EAN*   | Qty |
|---------|--------|-----|
| 8131A   | 313090 | 6   |

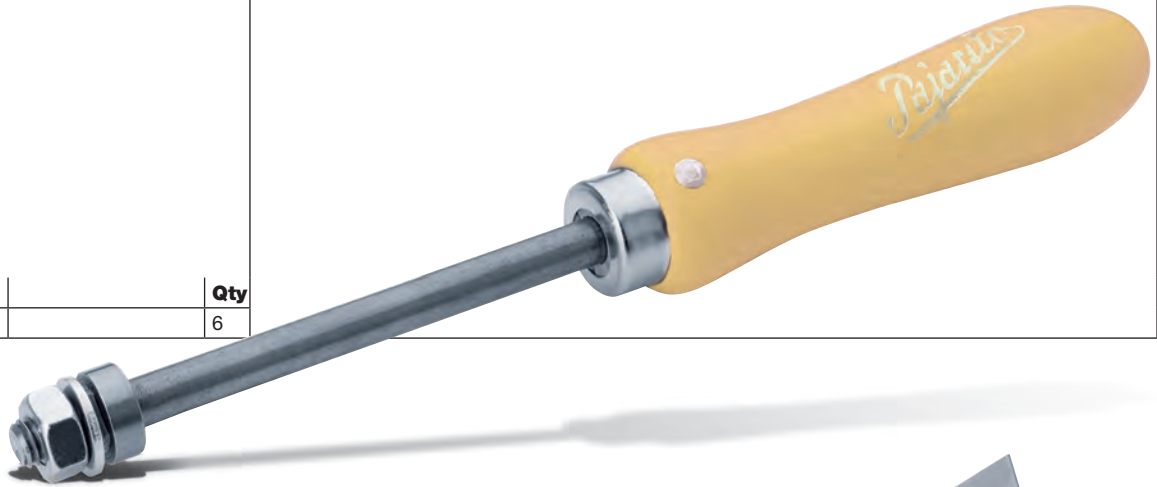

**Triangular blade**

**Spare blades**

Hardened, special steel, 1.4 mm thick, square hole, bevelled on all sides.

| Item No | EAN*   | Qty |
|---------|--------|-----|
| 8131E   | 313120 | 6   |

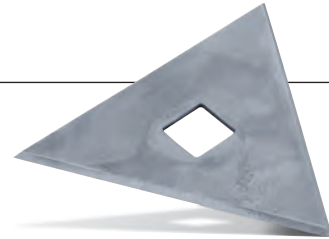

**Drop shaped blade**

**Spare blades**

Quality as Item No 8131E.

| Item No | EAN*   | Qty |
|---------|--------|-----|
| 8132E   | 313212 | 6   |

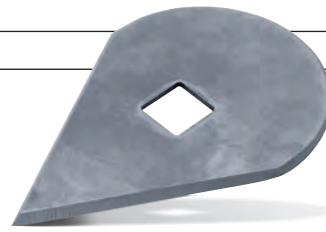

**All-purpose blade**

**Spare blades**

Quality as Item No 8131E.

| Item No | EAN*   | Qty |
|---------|--------|-----|
| 8133E   | 313311 | 6   |

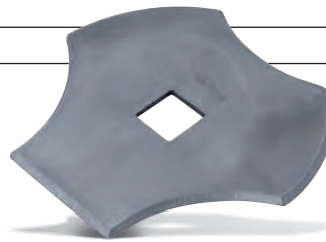

**NOVUS**  
**STEINEL**  
PROFESSIONAL



**We carry the complete Steinel Novus range!**

**Our sales team is there to advise you.**

**Catalogue orders phone +49 2104 / 30000**



| Paint scraper with holster  |        |             |     |
|---|--------|-------------|-----|
| Light alloy mounting, ergonomically shaped handle, triangular shape hard metal blade, 24 mm wide, bevelled on all sides, total length 190 mm. |        |             |     |
| Item No   | EAN*   | Blade width | Qty |
| 5600  | 591047 | 24 mm       | 5   |
| Sandvik-Spare blades  |        |             |     |
| Hard metal, used for Item No 5600.  |        |             |     |
| Item No   | EAN*   | Shape       | Qty |
| 5600E   | 591054 | Triangular  | 10  |
| 5600ER  | 591078 | Round       | 10  |
| 5600EB  | 591061 | Pear        | 10  |
| 5600ET  | 591085 | Drop        | 10  |



| Paint scraper   |        |             |     |
|---|--------|-------------|-----|
| Light alloy mounting, ergonomically shaped handle, two-sided hard metal blade, 50 mm wide, total length 250 mm. |        |             |     |
| Item No   | EAN*   | Blade width | Qty |
| 5601  | 591092 | 50 mm       | 5   |
| Spare blades (no illustration)  |        |             |     |
| 5601E   | 591108 | 50 mm       | 1   |



| Paint scraper   |        |             |     |
|---|--------|-------------|-----|
| Light alloy mounting, ergonomically shaped handle, plastic knob for additional pressure, two-sided hard metal blade, 64 mm wide, total length 250 mm. |        |             |     |
| Item No   | EAN*   | Blade width | Qty |
| 5602  | 591115 | 64 mm       | 5   |
| Spare blades (no illustration)  |        |             |     |
| 5602E   | 591122 | 64 mm       | 1   |



| Paint scraper MINI  |        |            |     |
|---|--------|------------|-----|
| Light alloy mounting, ergonomically shaped plastic handle, triangular shape hard metal blade, 24 mm wide, bevelled on all sides, total length 250 mm. Standard version. |        |            |     |
| Item No   | EAN*   | Dimensions | Qty |
| 8600  | 800071 | 24 mm      | 3   |
| Spare blades (no illustration)  |        |            |     |
| Hard metal, bevelled on all sides,  |        |            |     |
| 2600E   | 526049 | 24 mm      | 12  |



| Paint scraper UNIVERSAL  |        |            |     |
|--|--------|------------|-----|
| As Item No 2600, but with 50 mm wide, two-sided hard metal blade, total length 250 mm. Standard version. |        |            |     |
| Item No  | EAN*   | Dimensions | Qty |
| 8601   | 800088 | 50 mm      | 3   |
| Spare blades (no illustration)   |        |            |     |
| Hard metal, beveled on two sides.  |        |            |     |
| 2601E  | 526063 | 50 mm      | 12  |



| Paint scraper SUPER  |        |            |     |
|--|--------|------------|-----|
| As Item No 2600, but with plastic knob for additional pressure, two-sided hard metal blade, 64 mm wide, total length 300 mm. Standard version. |        |            |     |
| Item No  | EAN*   | Dimensions | Qty |
| 8602   | 800095 | 64 mm      | 3   |
| Spare blades (no illustration)   |        |            |     |
| Two-sided hard metal blade.  |        |            |     |
| 2602E  | 526087 | 64 mm      | 12  |

Please note: image scale of products may vary.



| Window and floor scraper   |        |             |     |
|--|--------|-------------|-----|
| Light alloy tubular shaft, plastic hand grip, blade holder for 100 mm wide special scraper blades, total length 250 mm. Blades are 0.4 mm thick and have a blunt edge on one side for rough scrape work and a sharp edge on the other side for delicate scraping and cleaning work. (For replacement blades see Item No 853E). |        |             |     |
| Item No  | EAN*   | Blade width | Qty |
| 853  | 585305 | 100 mm      | 6   |



| Window and floor scraper  |        |             |     |
|---|--------|-------------|-----|
| As Item No 853, but with 120 mm long hollow plastic handle for more delicate cleaning and scraping work, (For replacement blades see Item No 853E). |        |             |     |
| Item No   | EAN*   | Blade width | Qty |
| 853A  | 585329 | 100 mm      | 6   |



| Cleaning scraper   |        |             |     |
|--|--------|-------------|-----|
| Laquered metal, plastic handle, total length 300 mm, exchangeable blade. |        |             |     |
| Item No  | EAN*   | Blade width | Qty |
| 8853   | 708537 | 100 mm      | 10  |
| Replacement blades   |        |             |     |
| 10 x 10 pcs in plastic tear-off pouch, 0.4 mm thick.                     |        |             |     |
| Item No  | EAN*   | Blade width | Qty |
| 853E   | 585312 | 100 mm      | 10  |



| Scraper   |        |             |     |
|---|--------|-------------|-----|
| Steel shaft, plastic handle, quick release blade holder, 100 mm wide scraper blades (Item No 744E). |        |             |     |
| Item No   | EAN*   | Blade width | Qty |
| 744   | 504832 | 100 mm      | 6   |



| Scraper, long   |        |             |     |
|---|--------|-------------|-----|
| As Item No 744, but with a 500 mm long handle.  |        |             |     |
| Item No   | EAN*   | Blade width | Qty |
| 744L  | 005469 | 100 mm      | 6   |
| Spare blades for scrapers Item Nos 744 and 744L   |        |             |     |
| One blunt edge, one sharp edge 0.4 mm thick, 10 x 10 pcs in plastic tear-off pouch, 1 set = 10 pcs. |        |             |     |
| Item No   | EAN*   | Blade width | Qty |
| 744E  | 680307 | 100 mm      | 10  |



| Premium scraper SCR-L300   |        |             |     |
|--|--------|-------------|-----|
| Scraper with exchangeable blade, cast holder, reinforced shaft. For precision scrape work and tough chisel work. |        |             |     |
| Item No  | EAN*   | Blade width | Qty |
| 745  | 003632 | 110 mm      | 4   |
| 5711EK/O.K.  | 021070 | 18 mm       | 10  |

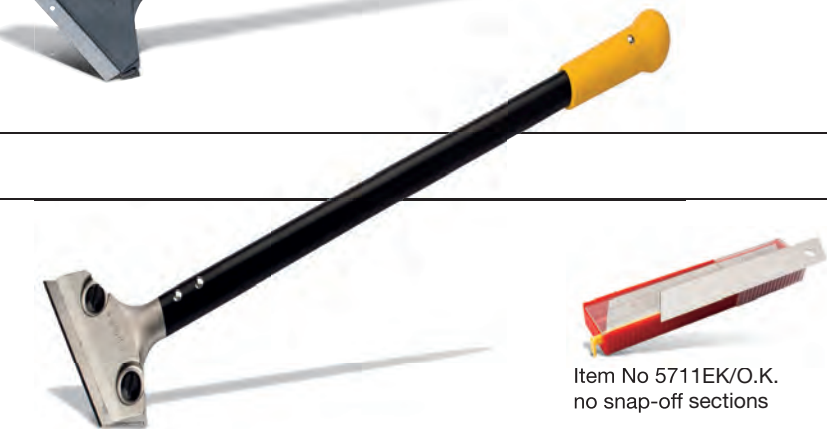

Item No 5711EK/O.K. no snap-off sections





**Made in Germany  
Made by Pajarito**

**Glass scraper**  
Nickel-plated steel, adjustable safety guard, wooden handle, exchangeable heavy-duty blade (Item No 155E see page 41).

| Item No | EAN*   | Qty |
|---------|--------|-----|
| 155     | 101550 | 12  |



**Glass cleaner**  
Plastic, blade guard, exchangeable heavy-duty blade (Item No 155E see page 41).

| Item No | EAN*   | Qty |
|---------|--------|-----|
| 652     | 506522 | 12  |



**Glass cleaner**  
Plastic, slide, exchangeable blade, 0.2 mm thick.

| Item No                                       | EAN*   | Qty |
|---|--------|-----|
| 8652  | 465201 | 20  |
| <b>Spare blades 0.20 mm (no illustration)</b> |        |     |
| 8652E   | 765219 | 100 |



**Paint and glass scraper**  
Stainless metal version, slide, exchangeable blade, 0.2 mm thick. (Item No 8652E).

| Item No | EAN*   | Dimensions | Qty |
|---------|--------|------------|-----|
| 8654    | 017127 | 40 mm      | 20  |



**Made in Germany  
Made by Pajarito**

**Glass cleaner set**  
Finger protection holder (Item No 172) and 25 blades (Item No 170), in plastic pouch.

| Item No   | EAN*   | Dimensions | Qty |
|---|--------|------------|-----|
| 171/60  | 517115 | 60 mm      | 12  |
| 171/80  | 517122 | 80 mm      | 12  |
| <b>Glass cleaner scraper</b>  |        |            |     |
| Cryogenically hardened, polished, lacquered steel, 0,2 mm thick, 25 pcs in plastic dispenser. |        |            |     |
| 170/60  | 517665 | 60 mm      | 25  |
| 170/80  | 517887 | 80 mm      | 25  |
| <b>Finger protection holder</b>   |        |            |     |
| Stainless steel, consisting of blade holder and safety guard.                                 |        |            |     |
| 172/60  | 517269 | 60 mm      | 1   |
| 172/80  | 517283 | 80 mm      | 1   |



**Made in Germany  
Made by Pajarito**

**Pulling scraper**  
Two hardened special steel blades, beveled on both sides, wooden handle holder.

| Item No                               | EAN*   | Dimensions | Qty |
|---------------------------------------|--------|------------|-----|
| 129/4                                 | 112945 | 40 mm      | 1   |
| 129/6                                 | 112969 | 60 mm      | 1   |
| 129/8                                 | 112983 | 80 mm      | 1   |
| <b>Spare blades (no illustration)</b> |        |            |     |
| Hardened special steel blades.        |        |            |     |
| 129E/4                                | 112938 | 40 mm      | 12  |
| 129E/6                                | 112921 | 60 mm      | 25  |
| 129E/8                                | 112914 | 80 mm      | 12  |

Please note: image scale of products may vary.

2

**Parquet flooring pull scraper**

Crucible cast steel, gently curved, sharpened blade, shaped wooden handle holder.

| Item No | EAN*   | Dimensions | Qty |
|---------|--------|------------|-----|
| 58/2    | 158202 | 20 mm      | 12  |
| 58/4    | 158400 | 40 mm      | 12  |
| 58/6    | 158608 | 60 mm      | 12  |
| 58/8    | 158806 | 80 mm      | 12  |
| 58/10   | 158103 | 100 mm     | 12  |
| 58/12   | 158127 | 120 mm     | 6   |



III Made in Germany  
Made by Pajarito

**Puller blade**

Rectangular shape, hardened, polished spring band steel, 150 x 60 mm.

| Item No | EAN*   | Dimensions | Qty |
|---------|--------|------------|-----|
| 59/0,8  | 159087 | 0,8 mm     | 12  |



III Made in Germany  
Made by Pajarito

**Rust chisel**

Hardened special steel, beveled on both sides, 220 mm long blade, 3 mm thick, 75 mm wide, beech handle, cross-riveted iron ferrule.

| Item No | EAN*   | Total length | Qty |
|---------|--------|--------------|-----|
| 128/60  | 112860 | 600 mm       | 1   |
| 128/80  | 112884 | 800 mm       | 1   |
| 128/100 | 112815 | 1000 mm      | 1   |

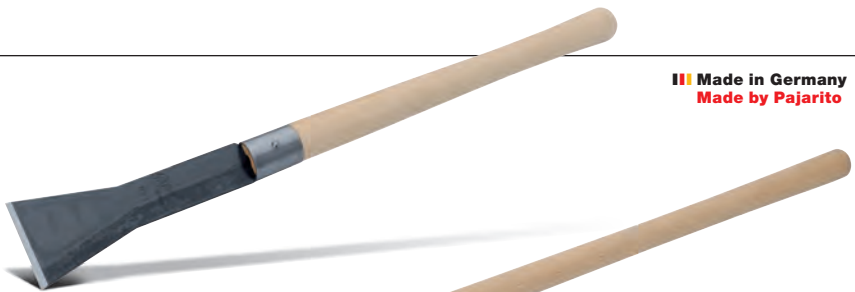

III Made in Germany  
Made by Pajarito

**Rust chisel**

Hardened special steel, beveled on both sides, 150 mm long blade, 3 mm thick, 85 mm wide, beech handle, cross-riveted iron ferrule.

| Item No | EAN*   | Total length | Qty |
|---------|--------|--------------|-----|
| 138     | 101383 | 950 mm       | 1   |



III Made in Germany  
Made by Pajarito

**Floorscraper, requires blade**

Tubular steel shaft, lacquered, 1400 mm long, with 300 mm wide, welded-on spine to take a steel blade. Delivery without blade, (required blade see Item No 850E).

| Item No | EAN*   | Total length | Qty |
|---------|--------|--------------|-----|
| 850A    | 185055 | 1400 mm      | 1   |

**Scraper blade**

Hardened, polished spring band steel, 0.8 mm thick, 115 mm height.

| Item No | EAN*   | Dimensions | Qty |
|---------|--------|------------|-----|
| 850E    | 185017 | 300 mm     | 1   |



III Made in Germany  
Made by Pajarito

**Push scraper**

Tubular steel shaft, lacquered, 1400 mm long, with 150 mm wide, welded-on spine to take a steel blade. Delivery without blade, (required blade see Item No 846E).

| Item No | EAN*   | Total length | Qty |
|---------|--------|--------------|-----|
| 846A    | 184638 | 1400 mm      | 1   |

**Push scraper blade**

Hardened, polished, beveled spring band steel, 2 mm thick, 150 mm height.

| Item No | EAN*   | Dimensions | Qty |
|---------|--------|------------|-----|
| 846E    | 184621 | 150 mm     | 1   |

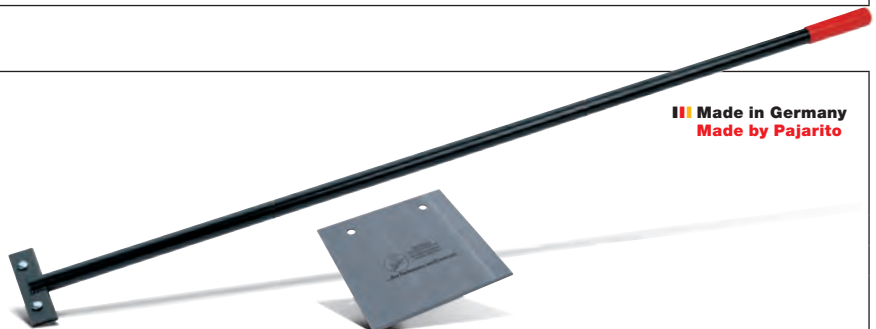

III Made in Germany  
Made by Pajarito



## From prototype to professional tool

**In-house tooling shop, superb craftsmanship, a large product portfolio, rapid availability, short delivery periods and competent consultation: that is the world of Pajarito.**

We attach great importance to high-quality materials, maximum precision and first-class processing quality in the manufacturing of our tools: demands, which you benefit from in your daily work. We manufacture branded goods and not just mass goods and provide appropriate, individual services on top. It is our strategy to meet

our customers' requirements as best we can – with specially developed top solutions for the trade and industry.

**Tools from Pajarito: made by professionals for professionals! That is why they are only available in the specialised trade.**

# Painting, wallpapering and EIFS tools

Our highlight product: **PAJARITO Wallpaper Shark** – perforates almost any wallcovering

Sturdy plastic knob for safe handling

Adjuster bolt to set the required perforation depth

Plastic protective cover for a secure placement on the surface.



3

Best of Pajarito! The Wallpaper Shark perforates almost any wallcovering (except fibreglass) on any surface. Simply place it on the wall, move it in straight lines over the covering - done, well done. The depth of perforation is adjustable. As a drive the Wallpaper Shark requires only a cordless drill or a corded drill with adjustable speed setting. Made in Germany – Made by Pajarito.

The **PAJARITO Wallpaper Shark** can be found on page 91.



All clean from page 82



DUOTEX cutter on page 96



Wallpaper smoothers on page 98



Smoothing roller from page 99

# Tidy work

3

**Made in Germany**  
**Made by Pajarito**



**Palette knife**  
Hardened, polished, finely ground, dry-fined, flexible, forged offset blade, pointed on one side, resin-embedded round tang, exotic-hardwood handle, brass ferrule.

| Item No      | EAN*   | Dimensions  | Qty |
|--------------|--------|-------------|-----|
| <b>30/16</b> | 530169 | 160 x 25 mm | 12  |

**Made in Germany**  
**Made by Pajarito**



**Palette knife**  
As Item No 30, but both edges straight.

| Item No      | EAN*   | Dimensions  | Qty |
|--------------|--------|-------------|-----|
| <b>31/16</b> | 531166 | 160 x 25 mm | 12  |

**Made in Germany**  
**Made by Pajarito**

**EDELSTAHL Rostfrei**



**Paint knife, stainless**  
Hardened, polished, stainless spring band steel blade, half-flat tang, fine-wood handle, 2 rivets.

| Item No       | EAN*   | Dimensions  | Qty |
|---------------|--------|-------------|-----|
| <b>49R/20</b> | 549208 | 200 x 33 mm | 12  |

**Made in Germany**  
**Made by Pajarito**



**Paint knife**  
Hardened, polished, stainless spring band steel, forged offset blade, half-flat tang, fine-wood handle, 2 brass rivets.

| Item No      | EAN*   | Dimensions  | Qty |
|--------------|--------|-------------|-----|
| <b>51/30</b> | 105152 | 300 x 36 mm | 6   |

**Made in Germany**  
**Made by Pajarito**

**EDELSTAHL Rostfrei**



**Paint knife, stainless**  
Hardened, highly polished, offset, flexible ground, stainless spring band steel blade, half-flat tang, fine-wood handle, 2 rivets.

| Item No    | EAN*   | Dimensions  | Qty |
|------------|--------|-------------|-----|
| <b>050</b> | 505006 | 160 x 50 mm | 6   |



**Paint kettle cleaner**  
Solvent-resistant special rubber, spoon shaped blade, 50 x 85 mm, exchangeable wooden handle.

| Item No   | EAN*   | Dimensions | Qty |
|-----------|--------|------------|-----|
| <b>25</b> | 502500 | 270 mm     | 6   |

Please note: image scale of products may vary.

# Gilder tools

| Gilder knife  |        |             |     |
|---|--------|-------------|-----|
| Hardened, polished, double-edged, dry-fined, flexible, forged offset blade, resin-embedded round tang, exotic-hardwood handle, brass ferrule. |        |             |     |
| Item No   | EAN*   | Dimensions  | Qty |
| 35  | 500353 | 150 x 20 mm | 12  |



| Gilder cushion  |        |              |     |
|---|--------|--------------|-----|
| Plywood board, foam padding, best suede leather covering, vellum wind protection. |        |              |     |
| Item No   | EAN*   | Dimensions   | Qty |
| 220   | 522010 | 255 x 150 mm | 1   |



Made in Germany  
Made by Pajarito

3

| Painter's canvas tautening pliers         |        |           |     |
|---|--------|-----------|-----|
| Annealed cast iron, spring, leather loop. |        |           |     |
| Item No                                   | EAN*   | Jaw width | Qty |
| 209                                       | 120902 | 65 mm     | 6   |
| 209/125                                   | 029182 | 125 mm    | 6   |

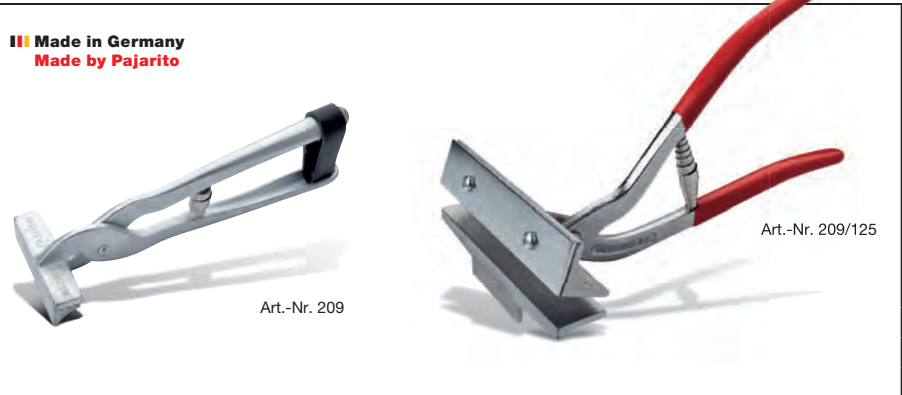

Made in Germany  
Made by Pajarito

| Paintstick  |        |            |     |
|---|--------|------------|-----|
| Well seasoned, knot-free wood, finely varnished, ball head. |        |            |     |
| Item No   | EAN*   | Dimensions | Qty |
| 39  | 500391 | 1000 mm    | 6   |



| Painter's straight edge                                     |        |            |     |
|---|--------|------------|-----|
| Well seasoned, knot-free wood, routed fluted on both sides. |        |            |     |
| Item No   | EAN*   | Dimensions | Qty |
| 114/1   | 511403 | 1000 mm    | 12  |
| 114/1,4   | 511427 | 1400 mm    | 12  |

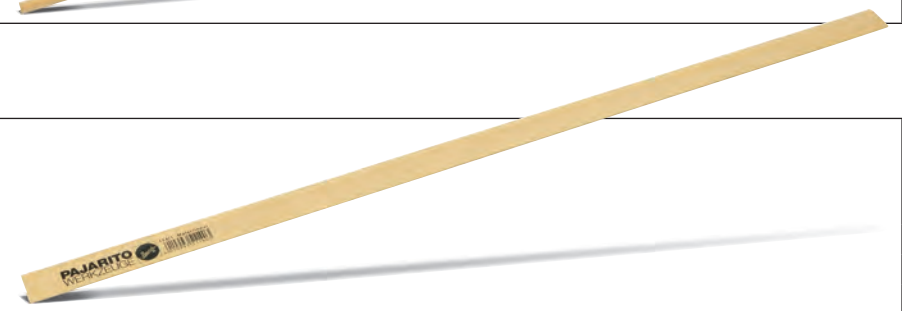

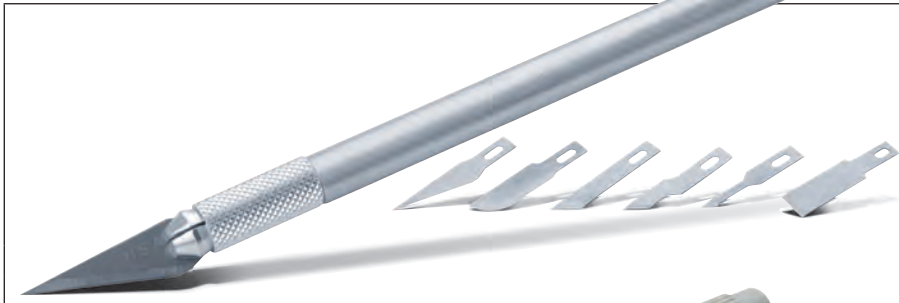

| Stencil knife  |        |            |     |
|--|--------|------------|-----|
| Light alloy stylus, 6 different blades, in plastic box. Excellent for stencil work and foil cutting. |        |            |     |
| Item No  | EAN*   | Dimensions | Qty |
| 66071  | 660712 | 160 mm     | 10  |

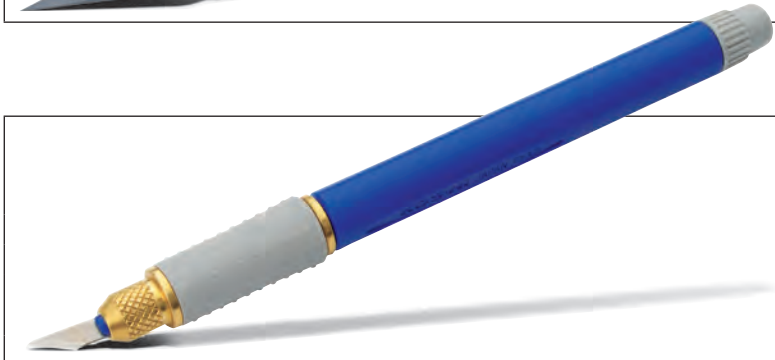

| Stencil knife   |        |            |     |
|---|--------|------------|-----|
| Plastic, anti-slip rubber grip, comes with 16 spare blades. |        |            |     |
| Item No   | EAN*   | Dimensions | Qty |
| 142   | 501459 | 135 mm     | 10  |
| Spare blades  |        |            |     |
| 48 pcs in a pack.   |        |            |     |
| 142E/K  | 506805 |            | 1   |

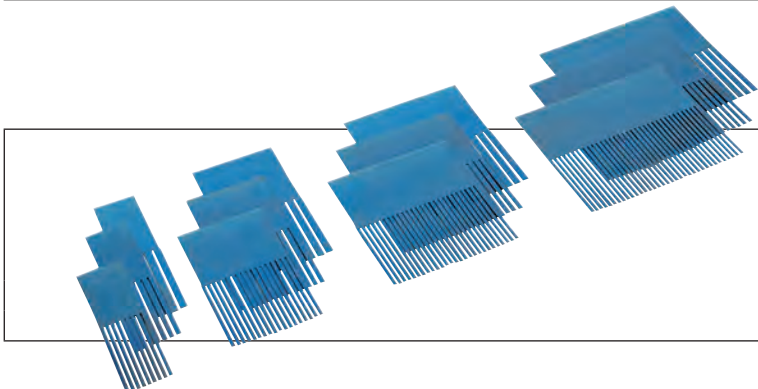

| Graining combs  |        |  |     |
|---|--------|--|-----|
| Blue steel, 0.5 mm thick, set of 12 in a plastic pouch. 1 set = 1 each 1, 2, 3, 4 inches wide, coarse, medium and fine toothings. |        |  |     |
| Item No   | EAN*   |  | Qty |
| 71  | 500711 |  | 1   |



| Graining boy   |        |            |     |
|--|--------|------------|-----|
| Black soft-PVC, one side with curved graining surface, the other side with a comb. |        |            |     |
| Item No  | EAN*   | Dimensions | Qty |
| 8072A  | 694106 | 100 mm     | 6   |
| 8072B  | 694007 | 150 mm     | 6   |



| Marking stencil  |        |  |     |
|--|--------|--|-----|
| Sheet metal. For the manufacture we require the artwork, or for standard lettering the text and size. Prices on request. |        |  |     |
| Item No  | EAN*   |  | Qty |
| 240  | 524236 |  | 1   |

Please note: image scale of products may vary.

| Metal letter stencils |        |        |     |
|-----------------------|--------|--------|-----|
| Complete set A - Z.   |        |        |     |
| Item No               | EAN*   | Height | Qty |
| 230/10                | 523017 | 10 mm  | 1   |
| 230/15                | 523024 | 15 mm  | 1   |
| 230/20                | 523031 | 20 mm  | 1   |
| 230/25                | 523048 | 25 mm  | 1   |
| 230/30                | 523055 | 30 mm  | 1   |
| 230/40                | 523079 | 40 mm  | 1   |
| 230/50                | 523093 | 50 mm  | 1   |
| 230/60                | 523109 | 60 mm  | 1   |
| 230/70                | 523116 | 70 mm  | 1   |
| 230/80                | 523123 | 80 mm  | 1   |
| 230/90                | 523130 | 90 mm  | 1   |
| 230/100               | 523147 | 100 mm | 1   |
| 230/120               | 523154 | 120 mm | 1   |
| 230/150               | 523161 | 150 mm | 1   |
| 230/180               | 002154 | 180 mm | 1   |
| 230/200               | 523178 | 200 mm | 1   |
| 230/250               | 524243 | 250 mm | 1   |
| 230/300               | 524250 | 300 mm | 1   |

 Made in Germany  
 Made by Pajarito



| Metal letter stencils |        |        |     |
|-----------------------|--------|--------|-----|
| Complete set a - z.   |        |        |     |
| Item No               | EAN*   | Height | Qty |
| 230K/10               | 523185 | 10 mm  | 1   |
| 230K/15               | 523192 | 15 mm  | 1   |
| 230K/20               | 523208 | 20 mm  | 1   |
| 230K/25               | 523215 | 25 mm  | 1   |
| 230K/30               | 523222 | 30 mm  | 1   |
| 230K/40               | 523246 | 40 mm  | 1   |
| 230K/50               | 523260 | 50 mm  | 1   |
| 230K/60               | 523277 | 60 mm  | 1   |
| 230K/70               | 523284 | 70 mm  | 1   |
| 230K/80               | 523291 | 80 mm  | 1   |
| 230K/90               | 523307 | 90 mm  | 1   |
| 230K/100              | 523314 | 100 mm | 1   |
| 230K/120              | 523321 | 120 mm | 1   |
| 230K/150              | 523338 | 150 mm | 1   |
| 230K/180              | 002161 | 180 mm | 1   |
| 230K/200              | 523345 | 200 mm | 1   |
| 230K/250              | 524298 | 250 mm | 1   |
| 230K/300              | 524304 | 300 mm | 1   |

 Made in Germany  
 Made by Pajarito



| Metal number stencils |        |        |     |
|-----------------------|--------|--------|-----|
| Complete set 0 - 9.   |        |        |     |
| Item No               | EAN*   | Height | Qty |
| 231/10                | 523352 | 10 mm  | 1   |
| 231/15                | 523369 | 15 mm  | 1   |
| 231/20                | 523376 | 20 mm  | 1   |
| 231/25                | 523383 | 25 mm  | 1   |
| 231/30                | 523390 | 30 mm  | 1   |
| 231/40                | 523413 | 40 mm  | 1   |
| 231/50                | 523437 | 50 mm  | 1   |
| 231/60                | 523444 | 60 mm  | 1   |
| 231/70                | 523451 | 70 mm  | 1   |
| 231/80                | 523468 | 80 mm  | 1   |
| 231/90                | 523475 | 90 mm  | 1   |
| 231/100               | 523482 | 100 mm | 1   |
| 231/120               | 523499 | 120 mm | 1   |
| 231/150               | 523505 | 150 mm | 1   |
| 231/180               | 680406 | 180 mm | 1   |
| 231/200               | 523512 | 200 mm | 1   |
| 231/250               | 524342 | 250 mm | 1   |
| 231/300               | 524359 | 300 mm | 1   |

 Made in Germany  
 Made by Pajarito



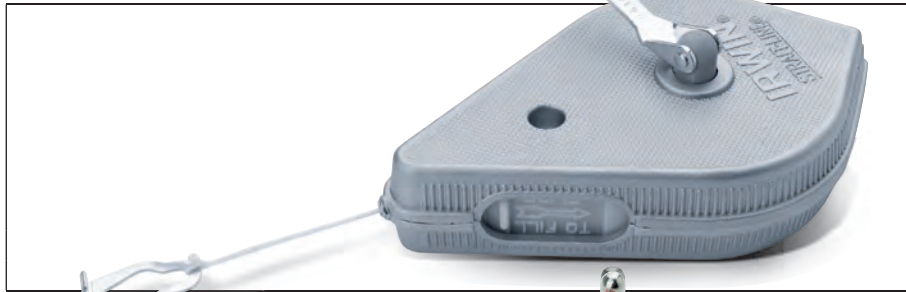

| Chalk lines  |        |  |     |
|--|--------|--|-----|
| Light metal casing, with crank, 15 mtr. long line. Suitable as plumb-line. |        |  |     |
| Item No  | EAN*   |  | Qty |
| 123  | 512301 |  | 6   |



| Chalk lines  |        |  |     |
|--|--------|--|-----|
| Sturdy zinc pressure-cast casing, with crank, 15 mtr. long line. Suitable as plumb-line. Blue chalk (60 g) included. |        |  |     |
| Item No  | EAN*   |  | Qty |
| 8124   | 600015 |  | 10  |



| Chalk   |        |        |     |
|---|--------|--------|-----|
| Light blue (BLAU), red (ROT) or ochre (OCKER). In handy refill container. |        |        |     |
| Item No   | EAN*   | Weight | Qty |
| 123K/1 blue   | 512332 | 45 g   | 12  |
| 123K/1 red  | 000280 | 45 g   | 12  |
| 123K/1 OCKER  | 000273 | 45 g   | 12  |

3



| Plum bob               |        |            |     |
|------------------------|--------|------------|-----|
| Iron, black lacquered. |        |            |     |
| Item No                | EAN*   | Dimensions | Qty |
| 175/10                 | 517504 | 100 mm     | 12  |



| Plumb bob and line                                  |        |            |     |
|---|--------|------------|-----|
| Complete set, plumb-bob and line. Standard version. |        |            |     |
| Item No   | EAN*   | Dimensions | Qty |
| 8175/239  | 630784 | 120 mm     | 12  |



| Natural sponge                       |        |  |     |
|--------------------------------------|--------|--|-----|
| Best quality, diameter about 140 mm. |        |  |     |
| Item No                              | EAN*   |  | Qty |
| 51014                                | 510147 |  | 10  |



| Viscose sponge                              |        |                   |     |
|---|--------|-------------------|-----|
| High quality, highly absorbent, boil-proof. |        |                   |     |
| Item No                                     | EAN*   | Dimensions        | Qty |
| 51013                                       | 510130 | 150 x 120 x 35 mm | 10  |

Please note: image scale of products may vary.

**Telescopic pole**

Anodised aluminium tube, outer tube profiled inside and outside, quick open and close action by twisting the thread, tapered end from GRP, provides a secure connection with other tools, i.e. paint-rollers.

| Item No | EAN*   | Dimensions   | Qty |
|---------|--------|--------------|-----|
| 653/75  | 030157 | 50 - 75 cm   | 10  |
| 653/130 | 003656 | 90 - 150 cm  | 10  |
| 653/200 | 003625 | 120 - 200 cm | 10  |
| 653/300 | 504467 | 170 - 300 cm | 10  |
| 653/400 | 503781 | 220 - 400 cm | 10  |

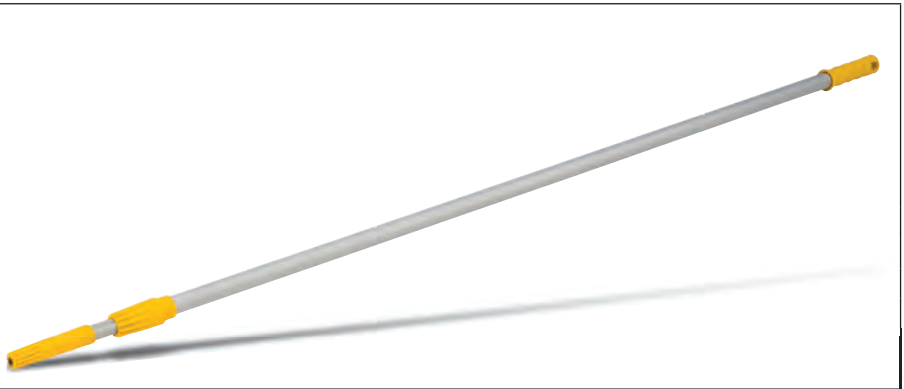

**Telescopic pole**

Anodised aluminium tube, quick locking with Single Lock System, tapered end from GRP.

| Item No | EAN*   | Dimensions      | Qty |
|---------|--------|-----------------|-----|
| 7653    | 003663 | 200 cm - 480 cm | 1   |



**Telescopic pole**

Steel tube, lacquered, plastic tapered end. Standard version.

| Item No | EAN*   | Dimensions   | Qty |
|---------|--------|--------------|-----|
| 8653    | 706533 | 113 - 200 cm | 10  |



**Brush holder**

Plastic, one end with tapered socket, the other end with clamping sleeve for brush handles, or similar, max. diameter about 40 mm.

| Item No | EAN*   | Dimensions | Qty |
|---------|--------|------------|-----|
| 653P    | 565390 |            | 6   |

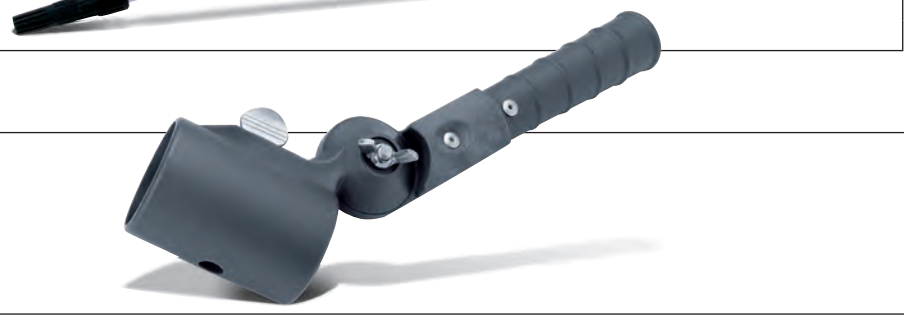

**Bucket grid**

Zinc-plated wire grid, handle, suspension hangers.

| Item No | EAN*   | Dimensions   | Qty |
|---------|--------|--------------|-----|
| 4801/22 | 548003 | 220 x 300 mm | 20  |
| 4801/26 | 448013 | 260 x 300 mm | 20  |
| 4802/26 | 030782 | 260 x 300 mm | 50  |

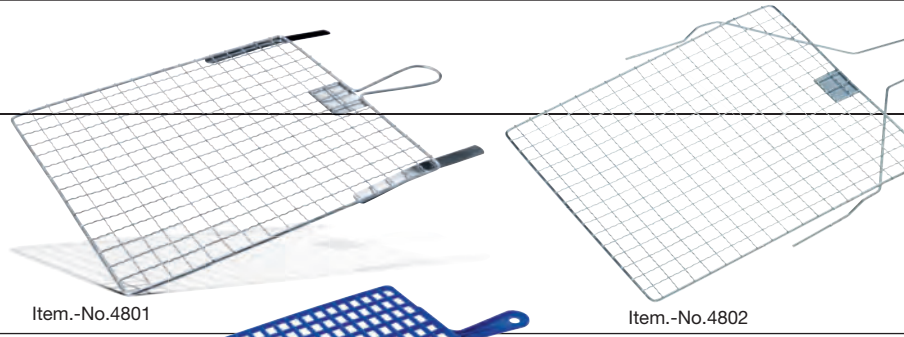

**Bucket grid**

Sturdy plastic, suspension fitting.

| Item No | EAN*   | Dimensions   | Qty |
|---------|--------|--------------|-----|
| 8480    | 691006 | 270 x 290 mm | 50  |

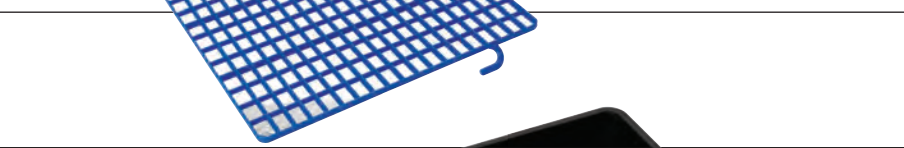

**Paint tray**

Plastic, solvent-resistant.

| Item No | EAN*   | Dimensions   | Qty |
|---------|--------|--------------|-----|
| 4810A   | 548027 | 185 x 195 mm | 50  |
| 4810B   | 548119 | 240 x 310 mm | 50  |

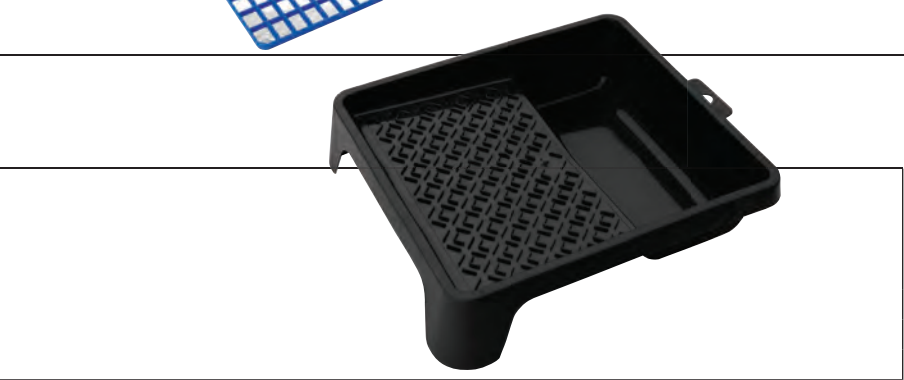

# Paint & brush pots



**Pour and Go**  
Optimised pouring of paints and varnishes.

- No dripping, no runs.
- Almost complete draining of paint-tins.
- Easy to use.
- For 750-1000ml tins.

| Item No | EAN*   |  | Qty |
|---------|--------|--|-----|
| 75278   | 029434 |  | 20  |



**Store and Go XL**  
Professional storage of brushes in XL.

- Airtight sealable lid.
- Also for radiator brushes.
- Includes 2 x brush gel (Item No 75281).
- 1x Clean and Go (Item No 75276).
- 8x brush-clips for 16-24 brushes.
- 2x large, dividable container-compartments.

| Item No | EAN*   | Dimensions | Qty |
|---------|--------|------------|-----|
| 75279   | 029489 | 490x300mm  | 1   |



**Gel refill**  
Brush gel for quick storage of clean and used brushes. No spreading of bristles. Gel is fungicidal and anti-corrosive.

| Item No | EAN*   | Content | Qty |
|---------|--------|---------|-----|
| 75281   | 029502 | 1,5l    | 1   |



**Store and Go Basic**  
Professional storage of brushes..

Contains:

- 1x brush gel (Item No 75281).
- 2x brush-clips for 4-8 brushes.

| Item No | EAN*   | Dimensions | Qty |
|---------|--------|------------|-----|
| 75280   | 029496 |            | 1   |



**Roll and Go**  
Paint and brush in one hand, paint roller in the other. Offers room to move. User-friendly, even on the ladder. Hooked on a rung, *Roll and Go* makes for better safety at work. Vertical roll area for paint rollers. The sharp striking tap, which allows the brush to be struck off well and allows the paint to flow back into *Roll and Go*.

| Item No | EAN*   |  | Qty |
|---------|--------|--|-----|
| 277     | 023067 |  | 24  |

Please note: image scale of products may vary.



**Clean and Go**

Suitable for any brush. Metal grid, to clean off paint residue from the bristles. Afterwards the brush can be left in the pot, dirt and old paint can be discarded later by removing the inner liner bag.

| Item No | EAN*   | Description       | Qty |
|---------|--------|-------------------|-----|
| 75276   | 027188 | Complete set      | 12  |
| 75276FK | 028611 | Paint kettle      | 60  |
| 75276F  | 028628 | Filter bag        | 10  |
| 75276V  | 028635 | Connector ring    | 75  |
| 75276D  | 028642 | Lid / Hood        | 120 |
| 75276P  | 028659 | Brush clip, small | 100 |
| 75276PG | 029663 | Brush clip, large | 100 |



**Paint and Go**

Painting-bucket complete system. Fill the paint into the liner, place the liner in the kettle - freedom of movement. For changing colours just replace the liner.

Set content: 3x plastic liners  
3x lids  
1x brush clip

| Item No | EAN*   | Description    | Qty |
|---------|--------|----------------|-----|
| 75277   | 027195 | Complete set   | 18  |
| 75277FK | 028666 | Paint kettle   | 60  |
| 75277D  | 028673 | Lid            | 20  |
| 75277K  | 028680 | Plastic insert | 120 |
| 75277P  | 028697 | Brush clip     | 10  |



Art.-Nr. 279



Art.-Nr. 279P

**Brush pot**

Plastic, clip-ring for 6 brushes.

| Item No | EAN*   | Dimensions   | Qty |
|---------|--------|--------------|-----|
| 279     | 527909 | 135 x 300 mm | 15  |

**Professional brush pot**

As Item No 279, but with bail handle and reinforced clip-ring for 8 brushes.

|      |        |              |    |
|------|--------|--------------|----|
| 279P | 527923 | 210 x 320 mm | 10 |
|------|--------|--------------|----|

**Roller tube**

Plastic, solvent-resistant, inner diameter 110 mm.

| Item No | EAN*   | Dimensions | Qty |
|---------|--------|------------|-----|
| 4455    | 544555 | 330 mm     | 1   |



**Paint bucket**

Plastic, oval, conical shape, bailing, zinc-plated metal-handle, 18 litres.

| Item No | EAN*   | Dimensions   | Qty |
|---------|--------|--------------|-----|
| 702/18  | 570219 | 360 x 280 mm | 1   |



# Clean in a flash

■ Made in Germany  
 Made by Pajarito



| PAJARITO cleaning tube  |        |            |     |
|---|--------|------------|-----|
| Impact-resistant plastic, copper tap connector. For time saving washing of paint rollers. Cleaning duration between 1-2 minutes, depending on degree of soiling. Overall length 400 mm, hose length 2 m, hose connection set. |        |            |     |
| Item No   | EAN*   | Dimensions | Qty |
| 4444  | 144441 | 400 mm     | 1   |

3



| Paint roller cleaner   |        |  |     |
|--|--------|--|-----|
| Plastic, with hose for water supply, drainage with threaded cap. |        |  |     |
| Item No  | EAN*   |  | Qty |
| 8444   | 669111 |  | 1   |

Please note: image scale of products may vary.

# Cups & bowls

| Plaster cup, rubber |        |             |     |
|---------------------|--------|-------------|-----|
| Conical shape.      |        |             |     |
| Item No             | EAN*   | Dimensions  | Qty |
| 88                  | 500889 | 125 x 90 mm | 1   |



| Plaster cup                     |        |             |     |
|---------------------------------|--------|-------------|-----|
| Conical shape, black, soft PVC. |        |             |     |
| Item No                         | EAN*   | Dimensions  | Qty |
| 8088                            | 700883 | 120 x 90 mm | 1   |



| Plaster cup, rubber |        |             |     |
|---------------------|--------|-------------|-----|
| Cylindrical shape.  |        |             |     |
| Item No             | EAN*   | Dimensions  | Qty |
| 880/125             | 488002 | 125 x 50 mm | 1   |
| 880/150             | 488019 | 150 x 60 mm | 1   |



| Plaster cup                         |        |             |     |
|-------------------------------------|--------|-------------|-----|
| Cylindrical shape, black, soft PVC. |        |             |     |
| Item No                             | EAN*   | Dimensions  | Qty |
| 8880                                | 708803 | 150 x 50 mm | 1   |



| Plaster bowl                                      |        |             |     |
|---|--------|-------------|-----|
| Rigid vinyl, large eye for hanging on to ladders. |        |             |     |
| Item No   | EAN*   | Dimensions  | Qty |
| 703   | 507031 | 180 x 80 mm | 1   |





**Measuring jug**  
Oil and acid resistent plastic, with handle and spout, ml graduation.

| Item No        | EAN*   | Volume | Qty |
|----------------|--------|--------|-----|
| <b>287/0,5</b> | 680833 | 0,5 l  | 1   |
| <b>287/1</b>   | 681502 | 1,0 l  | 1   |
| <b>287/2</b>   | 528760 | 2,0 l  | 1   |
| <b>287/3</b>   | 680901 | 3,0 l  | 1   |
| <b>287/5</b>   | 681007 | 5,0 l  | 1   |



**Funnel**  
Oil and acid resistent plastic.

| Item No       | EAN*   | Diam. top/bottom | Qty |
|---------------|--------|------------------|-----|
| <b>282/8</b>  | 528210 | 80 mm/9 mm       | 1   |
| <b>282/10</b> | 528227 | 100 mm/10 mm     | 1   |
| <b>282/12</b> | 528234 | 120 mm/11 mm     | 1   |
| <b>282/15</b> | 528258 | 150 mm/15 mm     | 1   |
| <b>282/20</b> | 528265 | 200 mm/17 mm     | 1   |
| <b>282/25</b> | 528272 | 250 mm/45 mm     | 1   |



**Oval distemper sieve**  
Zinc-plated wire frame, 2 extendable handles to rest on a paint bucket.

| Item No     | EAN*   | Dimensions   | Qty |
|-------------|--------|--------------|-----|
| <b>8464</b> | 005056 | 320 x 210 mm | 1   |



**Round distemper sieve**  
Zinc-plated wire frame with long handle and 2 hooks to rest on a paint bucket.

| Item No     | EAN*   | Dimensions | Qty |
|-------------|--------|------------|-----|
| <b>8291</b> | 005063 | 260 mm     | 1   |



**Cup filter**  
Perlon fabric, to insert in a spraygun cup. Short passage time despite fine mesh.

| Item No    | EAN*   | Dimensions  | Qty |
|------------|--------|-------------|-----|
| <b>458</b> | 504580 | 75 x 130 mm | 20  |



**Disposable sieve**  
Paper, with glued-in sieve fabric, upper diameter about 160 mm.  
New: colour-coded High-Tech-Nylon sieve material, the former cotton fabric has been replaced by nylon fabric, the result are different 'my' sizes.

| Item No     | EAN*   | Dimensions    | Qty |
|-------------|--------|---------------|-----|
| <b>459F</b> | 445906 | 190 my yellow | 100 |
| <b>459M</b> | 445913 | 260 my orange | 100 |



**Dust wiper**  
Pure cotton, non-bleached. Won't dry out! Use before paint applications on wood, metal, plastic, and similar. Size 450 x 850 mm.

| Item No      | EAN*   | Content | Qty |
|--------------|--------|---------|-----|
| <b>456/5</b> | 545620 | 5 pcs   | 100 |
| <b>456/1</b> | 630302 | 1 pc    | 100 |



Please note: image scale of products may vary.

# Clamps & hooks

## Plastic spring clamp

Impact-resistant plastic, flexible jaws, extra strong spring. Good for fixing covers and tarpaulins to scaffolds, gutterings, etc.

| Item No | EAN*   | Dimensions | Qty |
|---------|--------|------------|-----|
| 859/15  | 585916 | 150 mm     | 25  |



## Spring clamp

Zinc-plated metal, sturdy version.

| Item No | EAN*   | Dimensions | Qty |
|---------|--------|------------|-----|
| 858     | 694205 | 150 mm     | 20  |



## Ladder hooks

Round steel.

| Item No | EAN*   | Dimensions | Qty |
|---------|--------|------------|-----|
| 509     | 550907 |            | 12  |



## Profile ladder hooks

Round steel, shaped bending permits suspension of the hook on ladder rungs or side rails.

| Item No | EAN*   | Dimensions | Qty |
|---------|--------|------------|-----|
| 509P    | 550914 |            | 12  |

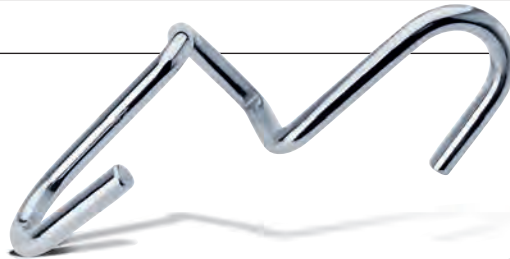

## Brush holder

Swivel metal ring eyes, wooden handle.

| Item No | EAN*   | Dimensions | Qty |
|---------|--------|------------|-----|
| 530     | 105305 |            | 12  |

Made in Germany  
Made by Pajarito



## Pins for golden-beading

Bright steel, glass-hard.  
Packed in box of 150 pcs.

| Item No | EAN*   | Dimensions | Qty |
|---------|--------|------------|-----|
| 245D    | 018674 | 32 mm      | 1   |

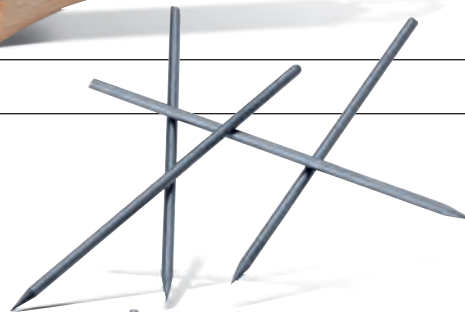

## Pins for panelling-beading

Bright, hardened steel.  
Pack of 1000 pcs.

| Item No | EAN*   | Dimensions | Qty |
|---------|--------|------------|-----|
| 517     | 505174 | 45 mm      | 1   |





| Pasting machine 'Tapomat'  |        |            |     |
|--|--------|------------|-----|
| Pasting machine, lacquered, sheet metal paste reservoir, plastic paste roller, 560 mm wide, cover plate, adjustable roller mounting. |        |            |     |
| Item No  | EAN*   | Dimensions | Qty |
| 5001   | 555018 | 560 mm     | 1   |



| Wallpapering table, height adjustable   |        |                  |     |
|---|--------|------------------|-----|
| New mechanism: the worktop height can be adjusted from 78 cm to 86 cm in one move, without loss of stability. Aluminium table frame with plywood sheets. Maximum load: 80 kg. |        |                  |     |
| Item No   | EAN*   | Dimens. (LxWxH)  | Qty |
| 6052  | 006749 | 305x60x78(86) cm | 1   |
| 6053  | 006947 | 305x80x78(86) cm | 1   |

3



| Door rack  |        |  |     |
|--|--------|--|-----|
| Wood, 125 x 400 mm, both long sides grooved. 1 set = 16 small wooden frames and 32 eye-bolts, to accept 8 doors max. |        |  |     |
| Item No  | EAN*   |  | Qty |
| 720  | 572008 |  | 1   |
| Spare iron eye-bolts   |        |  |     |
| 720E   | 572015 |  | 32  |

III Made in Germany  
Made by Pajarito



| Portable sprayer, small 8l  |        |  |     |
|---|--------|--|-----|
| Compact portable sprayer, sturdy plastic, 8 litre volume, 1,5 m adapter hose, spray adapter with flow control, pump mechanism can be locked down, comfortable transport with adjustable shoulder-strap. |        |  |     |
| Item No   | EAN*   |  | Qty |
| 71146   | 004967 |  | 1   |

Please note: image scale of products may vary.

# Drying rack

## Drying rack

Zinc-plated steel tubing, plastic end caps, swivelling, zinc-plated steel support pins. Can be dismantled for ease of transport. One set consist of 2 posts, to hold up to 10 varnished parts each.

| Item No | EAN*   | Dimensions    | Qty |
|---------|--------|---------------|-----|
| 721     | 107217 | 1030 x 310 mm | 1   |



**Made in Germany**  
**Made by Pajarito**



# Grinding discs & brushes

## Grinding discs, metal or stone

For metal or stone, 115 mm diameter, 25 pcs shrink-wrapped.

| Item No | EAN*   | Material | Qty |
|---------|--------|----------|-----|
| 51020   | 024781 | Metal    | 25  |
| 51021   | 024798 | Stone    | 25  |

Art.-Nr. 51020



Art.-Nr. 51021



## Wire cup brush

For angle grinders, with thread connection M14, crimped steel wire 0.3 mm.

| Item No | EAN*   | Diameter | Qty |
|---------|--------|----------|-----|
| 51030   | 510307 | 60 mm    | 1   |
| 51031   | 510314 | 80 mm    | 1   |



## Knotted wire wheel brush

For angle grinders, bristle tuft 10 mm wide, arbor hole 22,2 mm, oil-hardened knotted steel wire 0.5 mm.

| Item No | EAN*   | Dimensions | Qty |
|---------|--------|------------|-----|
| 51032   | 510321 | 115 mm     | 10  |



# Brushes

III Made in Germany  
Made by Pajarito



### Steel wire brush

Straight, hardened steel wire in tufts of 25 mm length.

| Item No | EAN*   | Number of rows | Qty |
|---------|--------|----------------|-----|
| 160/1   | 500957 | 1              | 12  |
| 160/2   | 500964 | 2              | 12  |
| 160/3   | 500971 | 3              | 12  |
| 160/4   | 500988 | 4              | 12  |
| 160/5   | 500995 | 5              | 12  |
| 160/6   | 501008 | 6              | 12  |

III Made in Germany  
Made by Pajarito



### Brass wire brush

As Item No 160, but with crimped brass wire tufts of 25 mm length.

| Item No | EAN*   | Number of rows | Qty |
|---------|--------|----------------|-----|
| 169/2   | 506683 | 2              | 12  |
| 169/3   | 506690 | 3              | 12  |
| 169/4   | 506706 | 4              | 12  |
| 169/5   | 506713 | 5              | 12  |
| 169/6   | 506720 | 6              | 12  |

III Made in Germany  
Made by Pajarito



Art.-Nr. 163

### Steel wire hand brush

Straight, hardened steel wire in tufts of 65 mm length, 4 rows.

| Item No | EAN*   | Dimensions | Qty |
|---------|--------|------------|-----|
| 163     | 501633 | 300 mm     | 6   |

III Made in Germany  
Made by Pajarito

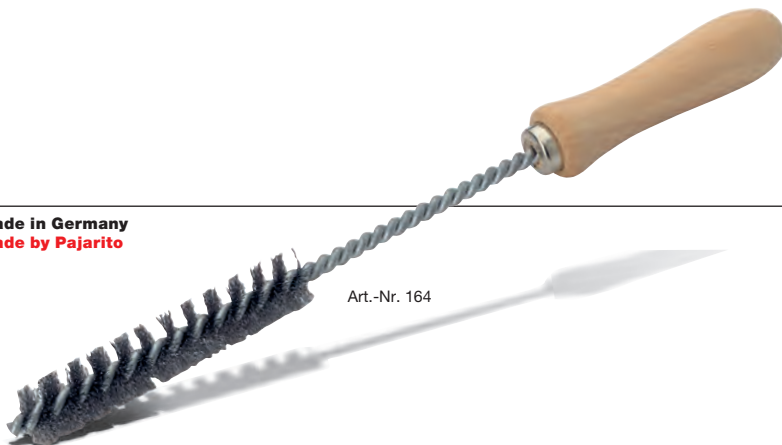

Art.-Nr. 164

### Steel wire tube brush, twisted

Zinc-plated, twisted steel wire shank, wooden handle, straight, hardened steel wire bristles.

| Item No | EAN*   | Diameter | Qty |
|---------|--------|----------|-----|
| 164/20  | 500148 | 20 mm    | 12  |

Please note: image scale of products may vary.

| <b>Wall brush</b>  |        |              |     |
|--|--------|--------------|-----|
| Straight, hardened steel wire in tufts of 35 mm length, oval shape, with woven belt strap. |        |              |     |
| Item No  | EAN*   | Dimensions   | Qty |
| 149  | 501497 | 100 x 210 mm | 2   |

III Made in Germany  
Made by Pajarito



| <b>Staining brush</b>  |        |             |     |
|--|--------|-------------|-----|
| Crimped, phosphor bronze wire and fibre bristles, in tufts of 20 mm length. Total length 220 mm. |        |             |     |
| Item No  | EAN*   | Dimensions  | Qty |
| 166  | 501664 | 60 x 150 mm | 6   |

III Made in Germany  
Made by Pajarito

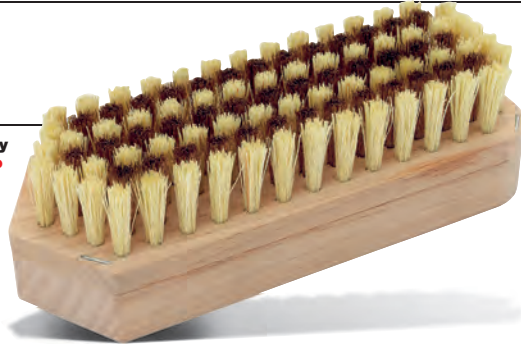

| <b>Polishing brush</b>  |        |             |     |
|---|--------|-------------|-----|
| Fibre bristles, in tufts of 20 mm length and leather centres. |        |             |     |
| Item No   | EAN*   | Dimensions  | Qty |
| 167   | 501671 | 60 x 150 mm | 6   |

III Made in Germany  
Made by Pajarito

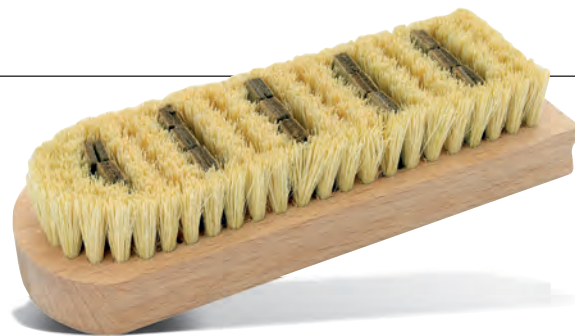

| <b>Staining brush</b>                                    |        |             |     |
|--|--------|-------------|-----|
| Crimped, phosphor bronze wire, in tufts of 15 mm length. |        |             |     |
| Item No  | EAN*   | Dimensions  | Qty |
| 168/150  | 500186 | 50 x 150 mm | 12  |
| 168/185  | 500193 | 60 x 185 mm | 12  |

III Made in Germany  
Made by Pajarito

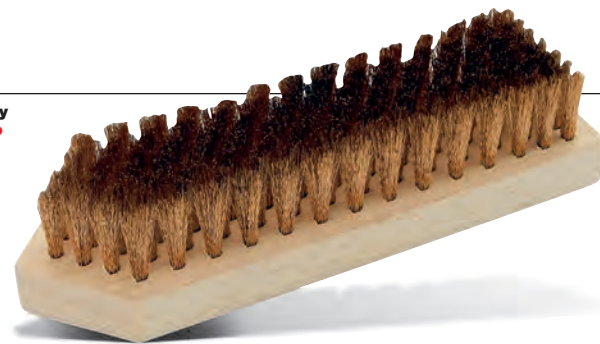

| <b>Spray-gun cleaning set</b>   |        |            |     |
|---|--------|------------|-----|
| 17-piece cleaning set for sprayguns, (suitable for all types), consists of 11 different brushes and 6 different reamers and broaches. |        |            |     |
| Item No   | EAN*   | Dimensions | Qty |
| 4433  | 001713 |            | 1   |



3

# Little wheels,

## PAJARITO-Power-Perfo for professionals:

Perforates professionally:

- + Inbuilt drive
- + Adjustable from 1000 to 2000 rpm
- + Covering bell from high-grade light-metal
- + Large 180 mm diameter
- + 6 perforating wheels
- + Made in Germany –  
Made by Pajarito

3



With 6 perforating wheels

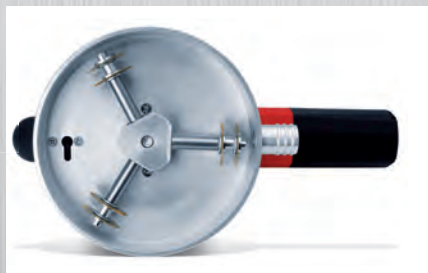

### Power-Perfo

Professional perforating of all kinds of wall coverings (except fibreglass) on any surfaces. Simply placed on the wall, moved in straight lines over the covering. Perforation depth is individually adjustable to the covering thickness. The regular perforations allow wallpaper remover to penetrate quicker and over larger areas.

#### Specifications:

230 V/50 Hz, 500 W, 1000 to 2000 rpm  
Weight: 3200 g

**Content:** systainer, with adjustment tools and hearing protection

| Item No | EAN*   | Qty |
|---------|--------|-----|
| 1000    | 012023 | 1   |

#### Spare perf. wheels for Power-Perfo

1 set = 6 pcs

|       |        |   |
|-------|--------|---|
| 1000E | 012030 | 1 |
|-------|--------|---|

**Optional grinding unit for Power-Perfo**  
For more detailed information see part 7, machines and accessories.

|      |        |   |
|------|--------|---|
| 1001 | 015680 | 1 |
|------|--------|---|

# that can run down any wallpaper

## Wallpaper Shark:

- + Fits on any standard electric drill with electronic speed control or any cordless drill
- + Adjustable perforating depth
- + Easy handling
- + Made in Germany – Made by Pajarito



With 3 perforator wheels



### Wallpaper Shark (Tapetenhai)

Perforates almost any wallcovering (except fibreglass) on any surfaces. Simply placed on the wall, moved in straight lines over the covering. Perforation depth is individually adjustable to the covering thickness. The regular perforations allow wallpaper remover to penetrate quicker and over larger areas.

#### Specifications:

Weight: 500 g. Diameter: 165 mm

**Content:** In PAJARITO-tin, with adjustment tools and manual

| Item No  | EAN*   | Qty |
|--|--------|-----|
| 1100   | 022305 | 1   |
| <b>Spare perf. wheels for Wallpaper Shark</b><br>1 set = 3 pcs |        |     |
| 1100E  | 022312 | 1   |



The Wallpaper Shark requires any standard electric drill with electronic speed control or any cordless drill as a drive. The attachment is clamped into the chuck like any other bit.

# Wallpaper destroyers



### Wallpaper steam stripper

Electrically heated, 7.5 litre corrosion-protected aluminium tank for about 90 min. steaming-time. Inbuilt step enlarges operating area to utilise 5 m cable and steam hose, pre-heat period about 15 min., steam supply about 5l/h, power consumption 2.2 KW, 230V/50Hz,14A

| Item No | EAN*   | Dimensions         | Qty |
|---------|--------|--------------------|-----|
| 9070    | 017431 | 440 x 475 x 465 mm | 1   |



### Perforator

Two angled steel-pinned brass rollers, each 75 mm wide, tilting light-alloy guide mount with plastic caster-wheel, 500 mm long wooden handle. Packed in cardboard box with protective covers.

| Item No | EAN*   | Total roller width | Qty |
|---------|--------|--------------------|-----|
| 906     | 596004 | 150 mm             | 1   |



Made in Germany  
Made by Pajarito

### Perforator in wooden case

Hardened pins on black coated perforating roller, 200 mm wide, nickel-plated steel frame, screwed-on wooden handle, 500 mm long, packed in varnished wooden case.

| Item No | EAN*   | Roller width | Qty |
|---------|--------|--------------|-----|
| 406     | 104063 | 200 mm       | 1   |

### Perforator

As Item No 406, but packed in cardboard box with protective covers.

|      |        |        |   |
|------|--------|--------|---|
| 406K | 104261 | 200 mm | 1 |
|------|--------|--------|---|



Made in Germany  
Made by Pajarito

### Perforator

Perforating roller with hardened pins, 180 mm wide, zinc-plated steel frame, screwed-on wooden handle, 500 mm long.

| Item No | EAN*   | Roller width | Qty |
|---------|--------|--------------|-----|
| 409     | 633921 | 180 mm       | 1   |



Made in Germany  
Made by Pajarito

### Perforating roll 'Perfoquick'

Perforating roll, 130 mm wide, with 9 razor-sharp star wheels, zinc-plated steel frame, wooden handle, 300 mm long.

| Item No | EAN*   | Roller width | Qty |
|---------|--------|--------------|-----|
| 8409    | 304098 | 130 mm       | 1   |



### Perforating tool 'Paper Tiger'

Plastic body, 3 swivelling, exchangeable perforating heads, each equipped with a pair of slanted blade wheels.

| Item No | EAN*   | Qty |
|---------|--------|-----|
| 908     | 509080 | 1   |

### Spare perforating head

Fitting Item No 908.  
1 set = 3 pairs of blade wheels

|      |        |   |
|------|--------|---|
| 908E | 509806 | 1 |
|------|--------|---|

Please note: image scale of products may vary.

# Painter's tool box



3

**III Made in Germany**  
**Made by Pajarito**

### Tool box for painters and decorators

- 1x Wallpaper scissors, stainless Item No 01500
- 1x Glass cutter Item No 154
- 1x Putty knife Item No 21
- 1x Snap-off knife, 18 mm Item No 57170
- 10x Snap-off blades, 18 mm Item No 5711EK
- 1x Plastic folding rule Item No 122K
- 1x Voltage tester Item No 55309
- 1x Paint scraper Item No 5601
- 1x Professional floorlayer knife Item No 555
- 10x Straight blades Item No 570EK
- 1x Mitre box Item No 262S
- 1x Sash saw Item No 9999
- 1x Spirit level Item No 332/60
- 1x Finishing trowel, stainless Item No 92R
- 1x Rapid spreader, 20 cm, stainless Item No 446R/20
- 1x Plaster cup Item No 880/125
- 1x Japanese spatula, stainless Item No 65R
- 1x Stucco work trowel, 10 cm, stainless Item No 104R/10
- 1x Stripping scraper, 6 cm Item No 2/6
- 1x Stripping scraper, 8 cm Item No 2/8
- 1x Stripping scraper, 10 cm Item No 2/10
- 1x Hand sander Item No 85A
- 1x Wallpaper smoother Item No 955
- 1x Chalk line box Item No 123
- 1x Chalk, blue Item No 123K
- 1x Finishing spreader, stainless Art.-Nr.7656R/60/9
- 1x Hammer, 200 g Item No 250/200
- 1x Pincers, 18 cm Item No 55621
- 1x Screw driver, 6 x Item No 10267
- 1x Viscose sponge Art.-Nr.51013
- 1x Gloves, PU Art.-Nr-8541PU
- 1x Tool box, empty Item No 602L

| Item No | EAN*   | Dimensions         | Qty |
|---------|--------|--------------------|-----|
| 602M    | 505334 | 685 x 425 x 240 mm | 1   |



**Wallpapering Pro Case**

- 1x Wallpaper scissors, stainless Item No 01500
- 1x Spreader Item No 5660RA/38
- 1x Chalk line box Item No 123
- 1x Paste injector Item No 966
- 1x Duo-Tex trimmer Item No 959R
- 1x Razor trimmer Item No 96
- 1x Wallpaper smoother Item No 033
- 1x Wallpaper smoother Item No 955
- 1x Plastic folding rule Item No 122K
- 1x Mitre cutter, stainless Item No 977R
- 1x Cutter knife Item No 5721
- 1x Seam roller Item No 749
- 1x Seam roller Item No 226M
- 1x NT-Cutter K200 RP Item No 5718
- 1x Stripping scraper Item No 2/6
- 1x Voltage tester Item No 55309
- 1x Japanese spatula, stainless Item No 65R
- 1x Rapid spreader, stainless Item No 446R20
- 1 pack Snap-off blades (see Item No 5711EK)
- 1x Smoothing roller, soft Item No 753W/18
- 1 pack Snap-off blades Item No 5710EK
- 1x Chalk in blue No 123k/1blue

| Item No | EAN*   | Dimensions         | Qty |
|---------|--------|--------------------|-----|
| 71296   | 018377 | 510 x 365 x 200 mm | 1   |

**Aluminium case, empty**



|        |        |                    |   |
|--------|--------|--------------------|---|
| 71296L | 018544 | 510 x 365 x 200 mm | 1 |
|--------|--------|--------------------|---|

3



**Apprentice tool box**

- 1x Wallpaper scissors, stainless Item No 8153
- 1x Pincers Item No 8255
- 1x Voltage tester Item No 55309
- 1x Hacksaw Item No 8414
- 1x Stucco work trowel Item No 8104R/8
- 1x Smoothing roller Item No 8753/18
- 1x Stripping scraper 30 mm Item No 8002/4
- 1x Stripping scraper 50 mm Item No 8002/6
- 1x Stripping scraper 70 mm Item No 8002/8
- 1x Japanese spatula set Item No 8165
- 1x Hand sander Item No 85B
- 1x Plaster cup, rubber Item No 88
- 1x Wooden folding rule Item No 122
- 1x Steel wire brush Item No 160/4
- 1x Hammer, 200 g Item No 250/200
- 1x Rapid spatula Item No 8446R/20
- 1x Seam roller Item No 8749
- 1x Wallpaper smoother Item No 955
- 1x Snap-off knife Item No 87170
- 1x Duster Item No 99055/22A
- 1x Tool box, empty Item No 606L

| Item No | EAN*   | Dimensions         | Qty |
|---------|--------|--------------------|-----|
| 71606   | 021162 | 575 x 390 x 175 mm | 1   |

Please note: image scale of products may vary.

Made in Germany  
Made by Pajarito



**Tool box, empty**

Spaciousness and convenient size make this tool box recommendable.  
Features are:  
Solid and durable due to the good finger mortise. Lockable.  
Lid compartment with plywood slide panel.  
Brush and spatula holder.

| Item No | EAN*   | Dimensions         | Qty |
|---------|--------|--------------------|-----|
| 607L    | 506072 | 600 x 300 x 400 mm | 1   |

Made in Germany  
Made by Pajarito



**Tool box, empty**

Laquered plywood, 15 mm thick, floor and lid 4 mm thick plywood, piano hinge, 2 hasp locks, metal corner protections. Removable tray for small items, size 630 x 250 x 70 mm.

| Item No | EAN*   | Dimensions         | Qty |
|---------|--------|--------------------|-----|
| 602L    | 503842 | 685 x 425 x 240 mm | 1   |

Made in Germany  
Made by Pajarito



**Tool box, empty**

Plywood, 12 mm thick, floor and lid 4 mm thick plywood, piano hinge, 2 hasp locks, metal corner protections.

| Item No | EAN*   | Dimensions         | Qty |
|---------|--------|--------------------|-----|
| 606L    | 500616 | 575 x 390 x 175 mm | 1   |



3



**Paste injector**  
Stainless steel needle and syringe.

| Item No | EAN*   | Volume | Qty |
|---------|--------|--------|-----|
| 965     | 596509 | 60 ml  | 10  |
| 966     | 509660 | 20 ml  | 12  |

III Made in Germany  
Made by Pajarito



**Wallpaper edger COMBIRAL**  
Ergonomic, plastic spatula for smoothing and trimming of cuttable wallcoverings with fleece backing, also fibreglass, textile and embossed wall coverings. Includes one mounted industrial blade, 0.30 mm thick (see Item No 665E).

| Item No | EAN*   | Dimensions | Qty |
|---------|--------|------------|-----|
| 954     | 509547 | 265 mm     | 12  |

III Made in Germany  
Made by Pajarito



**Pajarito DUOTEX trimmer, stainless**  
Safety shoe type trimmer for double cutting seams of wall coverings. Stainless steel, nickel-plated brass set-screw and knurled knob, moulded-on plastic handle, one mounted blade and 10 spare industrial blades included. (Spare blades see Item No 155E.) Individually packed in box.

| Item No | EAN*   | Dimensions | Qty |
|---------|--------|------------|-----|
| 959R    | 100553 |            | 12  |

III Made in Germany  
Made by Pajarito



**Pajarito Rex cutter**  
Edge trimmer specially for foamed wall coverings in all-metal design, nickel-plated, with one mounted and 10 spare industrial blades Item No 155E. individually packed in box.

| Item No | EAN*   | Dimensions | Qty |
|---------|--------|------------|-----|
| 960     | 109600 |            | 12  |

III Made in Germany  
Made by Pajarito



**Mitre cutter, stainless**  
Attachment unit for any cutter knife with 18 mm blade. Makes trimming the external corner area of wallcoverings, including textile and fleece coverings easier.

| Item No | EAN*   | Dimensions | Qty |
|---------|--------|------------|-----|
| 977R    | 017653 |            | 12  |

III Made in Germany  
Made by Pajarito



Art.-Nr. 77B

**Hacking knife, stainless**  
Hardened, polished steel blade, 1.4 mm thick, brown wooden handle with 3 rivets.

| Item No | EAN*   | Dimensions | Qty |
|---------|--------|------------|-----|
| 077B    | 100836 | 450 mm     | 6   |

III Made in Germany  
Made by Pajarito



**Steel straight edge, stainless**  
Hardened, polished spring band steel, 60 x 0.5 mm, with zinc-plated clip..

| Item No | EAN*   | Dimensions | Qty |
|---------|--------|------------|-----|
| 077A/2  | 100805 | 2000 mm    | 3   |
| 077A/3  | 100829 | 3000 mm    | 3   |

Please note: image scale of products may vary.

| Razor trimmer  |        |  |     |
|--|--------|--|-----|
| Nickel-plated metal parts, mounted industrial blade, adjustable blade protector, wooden handle. Individually packed in plastic pouch. Spare blades see Item No 155E. |        |  |     |
| Item No  | EAN*   |  | Qty |
| 96   | 196006 |  | 6   |

III Made in Germany  
Made by Pajarito



| Wallpaper scraper   |        |            |     |
|---|--------|------------|-----|
| Hardened, finely serrated special steel blade, lacquered steel holder, varnished wooden handle. |        |            |     |
| Item No   | EAN*   | Dimensions | Qty |
| 134   | 101345 | 600 mm     | 1   |

III Made in Germany  
Made by Pajarito

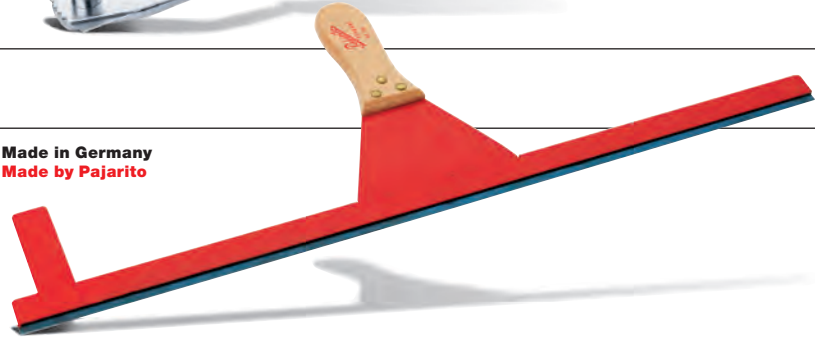

| Wallpaper scraper, stainless  |        |            |     |
|---|--------|------------|-----|
| Hardened, polished, stainless spring band steel, 0.4 mm thick, straight edges, finely serrated cutting edge, curved plywood handle, visible blade height 40 mm. Standard version. |        |            |     |
| Item No   | EAN*   | Dimensions | Qty |
| 8655RZ/25   | 681373 | 250 mm     | 10  |
| 8655RZ/60   | 681403 | 600 mm     | 6   |

III Made in Germany  
Made by Pajarito

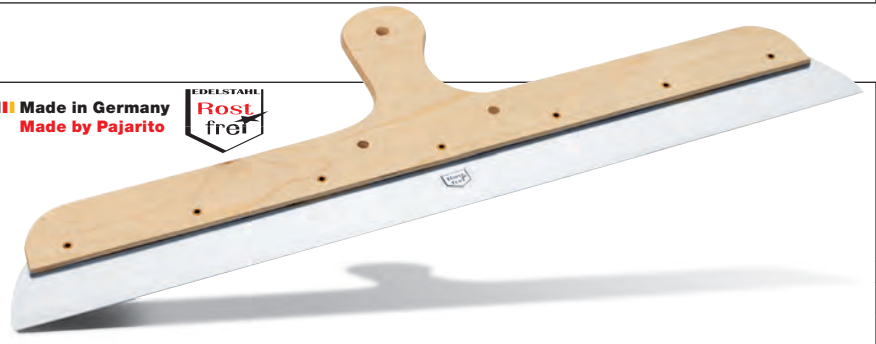

| Straight edge with spirit level  |        |         |     |
|--|--------|---------|-----|
| Plastic coated aluminium, 2.5 mm thick, 100 mm wide, 1200 mm long. with vertical and horizontal spirit levels, oblique wooden handle, total weight 1.2 kg. |        |         |     |
| Item No  | EAN*   | Length  | Qty |
| 334  | 133407 | 1200 mm | 1   |

III Made in Germany  
Made by Pajarito



| Trim guide  |        |        |     |
|---|--------|--------|-----|
| Non/warping light alloy profile, stainless steel cutting edge, for accurate cutting of wallpaper and other wallcoverings at ceilings, skirting boards, doors, windows, and so on. |        |        |     |
| Item No   | EAN*   | Length | Qty |
| 769   | 576907 | 585 mm | 1   |



| Trim guide, stainless                |        |        |     |
|--------------------------------------|--------|--------|-----|
| Stainless steel edge, plastic spine. |        |        |     |
| Item No                              | EAN*   | Length | Qty |
| 8773                                 | 707738 | 575 mm | 1   |



| Wallpaper smoother   |        |              |     |
|--|--------|--------------|-----|
| Ridgid PVC, 2 mm thick, trapezoid shape, corners and working edge rounded. |        |              |     |
| Item No  | EAN*   | Dimensions   | Qty |
| 033  | 100331 | 240 x 120 mm | 12  |

III Made in Germany  
Made by Pajarito



3

# Spreaders and rollers

3

**Made in Germany**  
**Made by Pajarito**



**Wallpaper smoother**  
Blade, oblique on one side, square on the other, 50 mm wide wooden grip.

| Item No | EAN*   | Dimensions   | Qty |
|---------|--------|--------------|-----|
| 956     | 109655 | 320 x 115 mm | 6   |



**Wallpaper smoother**  
Rigid plastic with bulge for smoothing wallpaper or wallcovering on outer corners.

| Item No | EAN*   | Dimensions   | Qty |
|---------|--------|--------------|-----|
| 957     | 509578 | 200 x 120 mm | 6   |



**Wallpaper smoother**  
Soft vinyl, very flexible working edge, one pointed and one rounded side.

| Item No | EAN*   | Dimensions   | Qty |
|---------|--------|--------------|-----|
| 958     | 509585 | 170 x 120 mm | 6   |



**Wallpaper smoother**  
Shatter-proof rigid PVC, the slot serves as blade guide when trimming wallpaper along the skirting board.

| Item No | EAN*   | Dimensions   | Qty |
|---------|--------|--------------|-----|
| 955     | 509554 | 240 x 120 mm | 12  |



**Wallpaper smoother**  
Rigid PVC, blade and grip.

| Item No | EAN*   | Dimensions   | Qty |
|---------|--------|--------------|-----|
| 8033    | 700333 | 200 x 120 mm | 12  |

Please note: image scale of products may vary.

# Location is position.

We produce quality German craftsmanship. Sustainable, precise, durable. Quality which is valued all over the world.

**Pajarito: German craftsmanship. Since 1923.**

**III Made in Germany**

| Smoothing roller   |        |             |     |
|--|--------|-------------|-----|
| Roller frame, plastic roller core and flanges, screwed-in core, sponge rubber cover, 6.5 mm thick. |        |             |     |
| Item No  | EAN*   | Dimensions  | Qty |
| 753  | 175308 | 50 x 180 mm | 2   |
| Spare roll   |        |             |     |
| 753E   | 175315 | 50 x 180 mm | 1   |



III Made in Germany  
Made by Pajarito

| Smoothing roller, soft  |        |             |     |
|---|--------|-------------|-----|
| Roller frame, click-locked plastic roller core, sponge rubber cover, 16.5 mm thick. |        |             |     |
| Item No   | EAN*   | Dimensions  | Qty |
| 753W/18   | 175322 | 55 x 180 mm | 2   |
| 753W/22   | 175339 | 55 x 220 mm | 2   |
| Spare roll  |        |             |     |
| 753WE/18  | 175346 | 55 x 180 mm | 1   |
| 753WE/22  | 175353 | 55 x 220 mm | 1   |



III Made in Germany  
Made by Pajarito

| Wallpaper smoothing roller  |        |            |     |
|---|--------|------------|-----|
| PU-foam roll, roller frame with plastic handle. Standard version. |        |            |     |
| Item No   | EAN*   | Dimensions | Qty |
| 8753/18   | 775317 | 180 mm     | 2   |

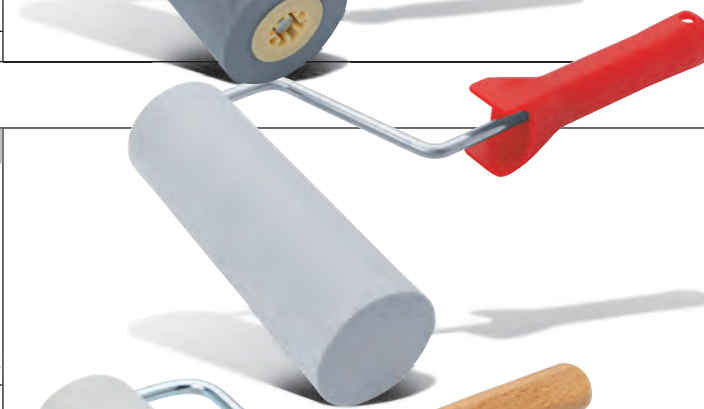

| Wallpaper smoothing roller, soft               |        |            |     |
|--|--------|------------|-----|
| PU-foam roll, roller frame with wooden handle. |        |            |     |
| Item No  | EAN*   | Dimensions | Qty |
| 8753W/18                                       | 691105 | 180 mm     | 2   |



3

# Seam rollers for professionals

3



**III Made in Germany**  
**Made by Pajarito**

**Seam roller**

Corrugated, oval, black plastic roller, nickel-plated side-arm frame, wooden handle.

| Item No | EAN*   | Dia. x Length | Qty |
|---------|--------|---------------|-----|
| 226     | 122609 | 35 x 50 mm    | 6   |



**Seam roller**

Corrugated, barrel-shaped, black plastic roller, nickel-plated side-arm frame, wooden handle. Standard version.

| Item No | EAN*   | Dia. x Length | Qty |
|---------|--------|---------------|-----|
| 8226    | 631408 | 35 x 50 mm    | 12  |



**III Made in Germany**  
**Made by Pajarito**

**Seam roller**

Smooth, conical, red plastic roller, nickel-plated side-arm frame, wooden handle.

| Item No | EAN*   | Dia. x Length | Qty |
|---------|--------|---------------|-----|
| 749     | 174905 | 30/35 x 32 mm | 6   |



**Seam roller**

Smooth, conical, white plastic roller, nickel-plated side-arm frame, wooden handle. Standard version.

| Item No | EAN*   | Dia. x Length | Qty |
|---------|--------|---------------|-----|
| 8749    | 631507 | 30/35 x 32 mm | 12  |



**III Made in Germany**  
**Made by Pajarito**

**Seam roller**

Smooth, barrel-shaped, red plastic roller, nickel-plated side-arm frame, wooden handle.

| Item No | EAN*   | Dia. x Length | Qty |
|---------|--------|---------------|-----|
| 226P    | 122661 | 35 x 50 mm    | 6   |



**III Made in Germany**  
**Made by Pajarito**

**Seam roller**

Cylindrical roll from PU-foam, nickel-plated side-arm frame, wooden handle.

| Item No | EAN*   | Dia. x Length | Qty |
|---------|--------|---------------|-----|
| 226M    | 122647 | 35 x 35 mm    | 6   |

Please note: image scale of products may vary.

| Seam roller   |        |               |     |
|---|--------|---------------|-----|
| Cylindrical roll from PU-foam, nickel-plated side-arm frame, wooden handle. Standard version. |        |               |     |
| Item No   | EAN*   | Dia. x Length | Qty |
| 8226M   | 631460 | 35 x 45 mm    | 12  |



| Corner roller   |        |               |     |
|---|--------|---------------|-----|
| Double ended plastic roller, for inner corners, 55 mm diameter, and outer corners 60 mm diameter, zinc-plated frame, wooden handle. |        |               |     |
| Item No   | EAN*   | Dia. x Length | Qty |
| 748   | 507482 |               | 5   |



III Made in Germany  
Made by Pajarito

| Smoothing roller   |        |               |     |
|--|--------|---------------|-----|
| Plastic roller core, cylindrical roll from hard rubber, 8 mm thick, nickel-plated side-arm frame, wooden handle. |        |               |     |
| Item No  | EAN*   | Dia. x Length | Qty |
| 751  | 107514 | 30 x 45 mm    | 6   |

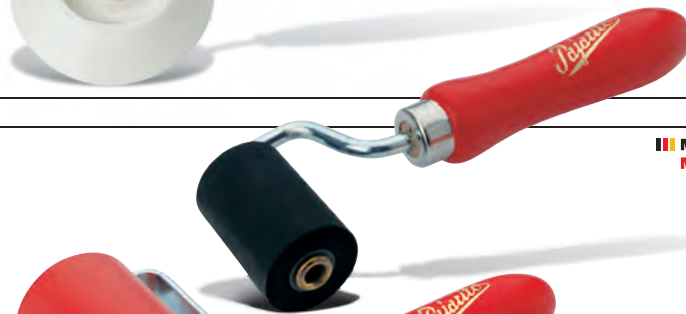

III Made in Germany  
Made by Pajarito

| Smoothing roller  |        |               |     |
|---|--------|---------------|-----|
| Plastic roller core and flanges, riveted steel axle, hard rubber cover, 4 mm thick. nickel-plated metal frame, wooden handle. |        |               |     |
| Item No   | EAN*   | Dia. x Length | Qty |
| 227/7,5   | 122777 | 50 x 75 mm    | 4   |
| 227/15  | 122715 | 50 x 150 mm   | 4   |



III Made in Germany  
Made by Pajarito

| Smoothing roller  |        |               |     |
|---|--------|---------------|-----|
| Plastic roller core and flanges, riveted steel axle, hard rubber cover, 4 mm thick. nickel-plated metal frame with 2 support legs, wooden handle. |        |               |     |
| Item No   | EAN*   | Dia. x Length | Qty |
| 754   | 107545 | 30 x 100 mm   | 6   |



III Made in Germany  
Made by Pajarito

| Smoothing roller  |        |               |     |
|---|--------|---------------|-----|
| Metal core and flanges, two ball bearings, hard rubber cover, 7 mm thick, zinc-plated frame, wooden handle. |        |               |     |
| Item No   | EAN*   | Dia. x Length | Qty |
| 229/5   | 001027 | 40 x 45 mm    | 4   |



III Made in Germany  
Made by Pajarito

| Smoothing roller   |        |               |     |
|--|--------|---------------|-----|
| Plastic core, metal flanges, two ball bearings, hard rubber cover, 4 mm thick, zinc-plated frame, wooden handle. |        |               |     |
| Item No  | EAN*   | Dia. x Length | Qty |
| 228/5  | 101031 | 47 x 50 mm    | 4   |
| 228/15   | 110095 | 47 x 150 mm   | 4   |



III Made in Germany  
Made by Pajarito



III Made in Germany  
Made by Pajarito



**Groove saw**

Coarse toothed metal saw blade, PVC guide plate, unvarnished wood. For cutting grooves into rigid, expanded PU insulating boards.

| Item No | EAN*   | Dimensions       | Qty |
|---------|--------|------------------|-----|
| 10395   | 103950 | 100 x 40 x 85 mm | 1   |

III Made in Germany  
Made by Pajarito  
ROSTFREI



**Special knife, stainless**

Polished stainless steel, bevelled on both sides with special tothing, wooden handle. For cutting of mineral fibre insulation materials.

| Item No | EAN*   | Dimensions | Qty |
|---------|--------|------------|-----|
| 10393   | 103936 | 330 mm     | 6   |

III Made in Germany  
Made by Pajarito



**Insulation material knife**

Stainless, one side serrated edge blade, 8" (20 cm) long, ergonomically shaped knuckle-handle.

| Item No | EAN*   | Dimensions | Qty |
|---------|--------|------------|-----|
| 824     | 019787 |            | 6   |

3



**Electric hot knife**

Permanent stainless steel blade, easily exchanged. For cutting rigid expanded PU foam sheets up to 140 mm. Ready to cut in 10 seconds. No dust-pollution, no static charge. 230 Volt, 50 Hz, 110 Watt, insulated, 3 m cable with European-type plug.

| Item No | EAN*   | Dimensions | Qty |
|---------|--------|------------|-----|
| 58838   | 588382 |            | 1   |

**Spare blade, stainless**

Fitting hot knife Item No 58838, stainless steel, 15 mm wide.

|        |        |        |   |
|--------|--------|--------|---|
| 58839  | 588399 | 140 mm | 1 |
| 58839L | 022213 | 160 mm | 1 |

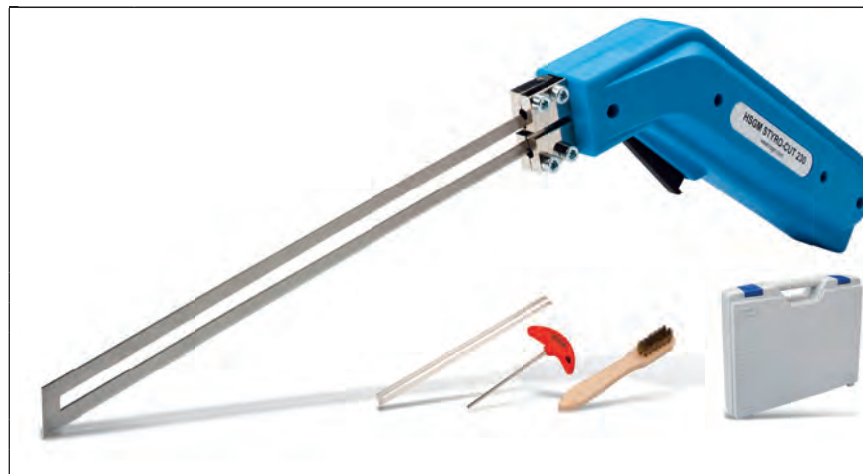

**Hot knife**

Permanent stainless steel blade, easily exchanged. For cutting rigid expanded PU foam sheets up to 230 mm. Ready to cut in 10 seconds. No dust-pollution, no static charge. Comes in a case, with 1 blade each (58841E - 58841EL)  
230 Volt/50 Hz, max. 230 W, insulated, 3 m cable with European-type plug.

| Item No | EAN*   | Dimensions | Qty |
|---------|--------|------------|-----|
| 58841   | 028703 |            | 1   |

**Spare blade, stainless**

Fitting hot knife Item No 58841, stainless steel, 15 mm wide.

|         |        |        |   |
|---------|--------|--------|---|
| 58841E  | 028710 | 200 mm | 1 |
| 58841EL | 028727 | 230 mm | 1 |

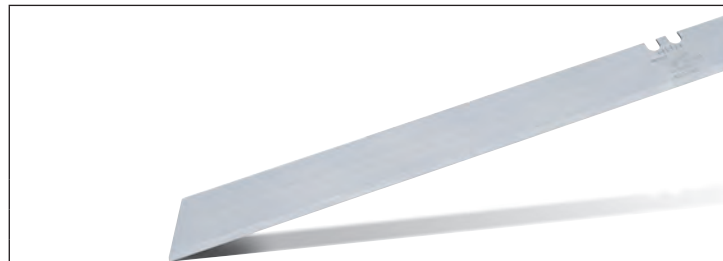

**Special blade**

Hardened, polished steel, 18 mm wide, 0.5 mm thick, 160 mm long, for cutting rigid expanded PU foam. 10 pcs in plastic box. To be used with any standard utility knife holder.

| Item No | EAN*   | Dimensions    | Qty |
|---------|--------|---------------|-----|
| 5716E   | 557180 | Straight cut  | 20  |
| 5716EW  | 557159 | Serrated edge | 20  |

Please note: image scale of products may vary.



## Have an idea? Built to your needs.

**Your experience is our inspiration. Your needs become the inspiration for new developments. And the basis for our work.**

**Pajarito: Always a good idea. And that since 1923.**



| <b>Polystyrene rasp</b>   |        |              |     |
|---|--------|--------------|-----|
| Aluminium plate, 2 mm thick, bonded-on hook-and-loop tape, screwed-on wooden handle, incl. 1 sheet corundum-coated paper. |        |              |     |
| Item No   | EAN*   | Dimensions   | Qty |
| 831/23  | 183112 | 230 x 110 mm | 2   |
| 831/50  | 183129 | 500 x 250 mm | 2   |
| <b>Corundum-coated paper</b>  |        |              |     |
| Fitting Item No 831, coarse, grain size 16, velvet backing.   |        |              |     |
| 831E/23   | 583110 | 230 x 110 mm | 6   |
| 831E/50   | 583127 | 500 x 250 mm | 6   |

**III Made in Germany  
Made by Pajarito**

| <b>Polystyrene rasp</b>   |        |              |     |
|---|--------|--------------|-----|
| Laminated wooden board, with self-adhesive corundum-coated paper. |        |              |     |
| Item No   | EAN*   | Dimensions   | Qty |
| 832/30  | 588207 | 300 x 150 mm | 2   |
| 832/50  | 588214 | 500 x 250 mm | 2   |
| <b>Corundum-coated paper, self-adhesive grain size 16</b>         |        |              |     |
| 832E/30   | 588221 | 300 x 150 mm | 6   |
| 832E/50   | 588238 | 500 x 250 mm | 6   |

**III Made in Germany  
Made by Pajarito**

| <b>EIFS - rasp</b>  |        |              |     |
|---|--------|--------------|-----|
| Polystyrene board, 2 component plastic handle, zinc-plated steel rasp sheet, to level polystyrene panels. |        |              |     |
| Item No   | EAN*   | Dimensions   | Qty |
| 327   | 026907 | 380 x 160 mm | 4   |

# The new cutting PROS

## PAJARITO Quick Cut 1881 & 1882

New transformer with 2 outputs: 24 V and additionally 8 V for the hand cutter

Cutting height: 28 cm; Cutting width: 105 cm

Made in Germany – Made by PAJARITO

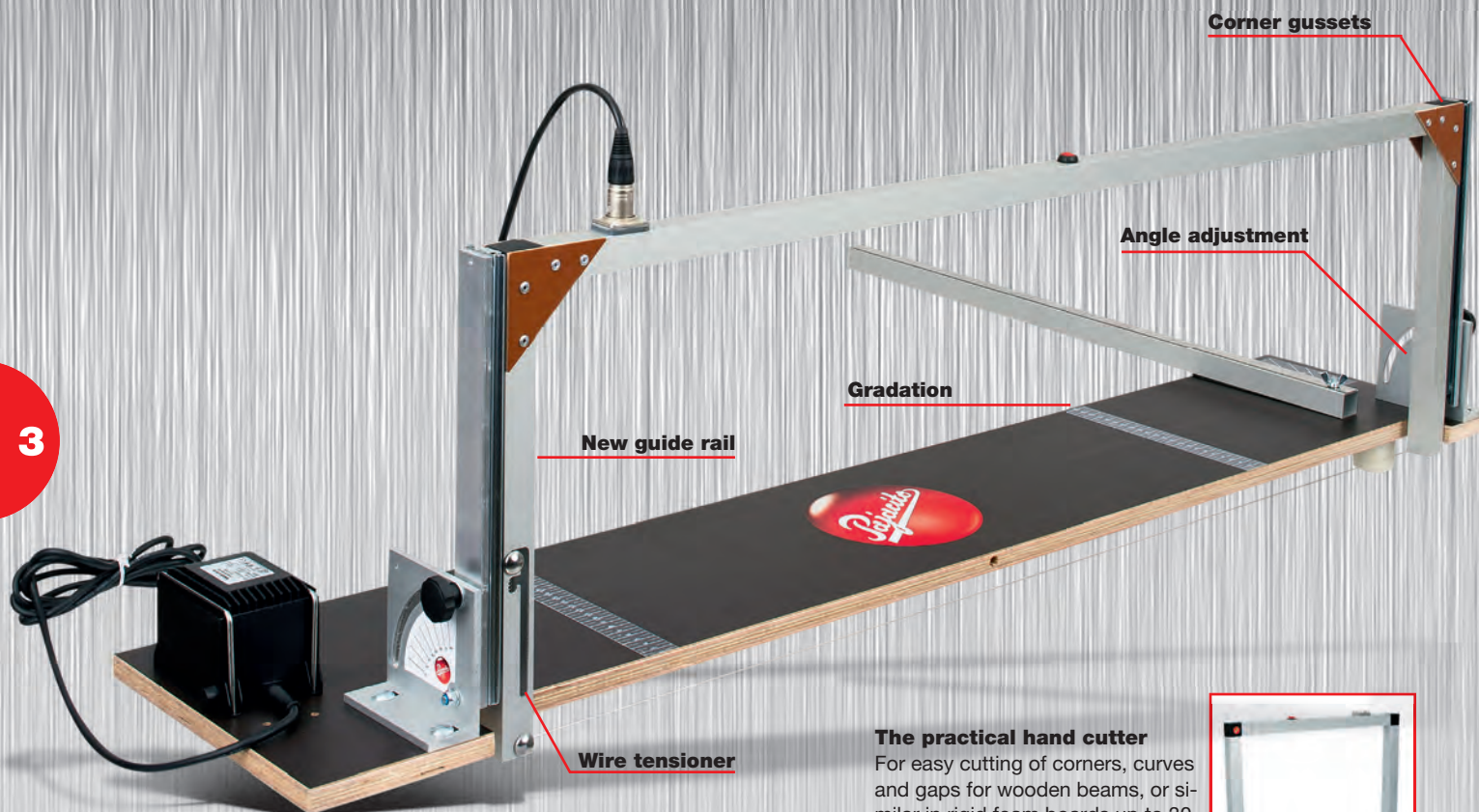

### The practical hand cutter

For easy cutting of corners, curves and gaps for wooden beams, or similar in rigid foam boards up to 30 cm thickness. Can only be used in combination with Quick Cut 1881, 1882 or 1890!



## Quick Cut 1881

### The new PAJARITO Quick Cut

Convincing with new, improved details. The 230-Volt cutter offers two voltages, 24 V and additionally 8 V for the hand cutter 1884. With new guide rails, corner gussets and improved wire tensioning, the Quick Cut convinces on all fronts.

Cutting height: 28 cm

Cutting width: 105 cm

| Item No              | EAN*   | Dimensions    | Qty |
|----------------------|--------|---------------|-----|
| <b>1881</b>          | 029281 | 132 x 26,5 cm | 1   |
| <b>Spare wire</b>    |        |               |     |
| <b>1881E</b>         | 029298 | Spare wire    | 1   |
| <b>Hand cutter</b>   |        |               |     |
| <b>1884</b>          | 029335 |               | 1   |
| <b>Spare wire</b>    |        |               |     |
| <b>1884E</b>         | 029342 | Spare wire HS | 1   |
| <b>Scaffold rack</b> |        |               |     |
| <b>1885</b>          | 029397 |               | 1   |

### Scaffold rack:

For PAJARITO Quick Cut  
Ideal surface for the pressure distribution.  
Height adjustable, suitable for any scaffold.



## Quick Cut 1882

### New PAJARITO Quick Cut Maxi

The new Quick Cut Maxi is identical with Item No 1881, but larger and suitable for boards up to 125 cm length and up to 36 cm thickness.

Cutting height: 36 cm

Cutting width: 125 cm

| Item No                 | EAN*   | Dimensions    | Qty |
|-------------------------|--------|---------------|-----|
| <b>1882</b>             | 029304 | 165 x 47 cm   | 1   |
| <b>Replacement wire</b> |        |               |     |
| <b>1882E</b>            | 029311 | Spare wire    | 1   |
| <b>Hand cutter</b>      |        |               |     |
| <b>1884</b>             | 029335 |               | 1   |
| <b>Replacement wire</b> |        |               |     |
| <b>1884E</b>            | 029342 | Spare wire HS | 1   |
| <b>Scaffold rack</b>    |        |               |     |
| <b>1885</b>             | 029397 |               | 1   |

# Quick Cut-Multi

## PAJARITO Quick Cut Multi 1890

- Precise and diverse cutting options
- Repeat cuts
- Cutting depth up to 28 cm
- Can be used as standing, suspended or table-top appliance
- Easy-to-read measurement scales
- Handle for transportation

### Your benefits:

- Price/Performance ratio
- Rational work
- High user convenience
- Short set-up times
- Easy to transport



OPERATING INSTRUCTIONS

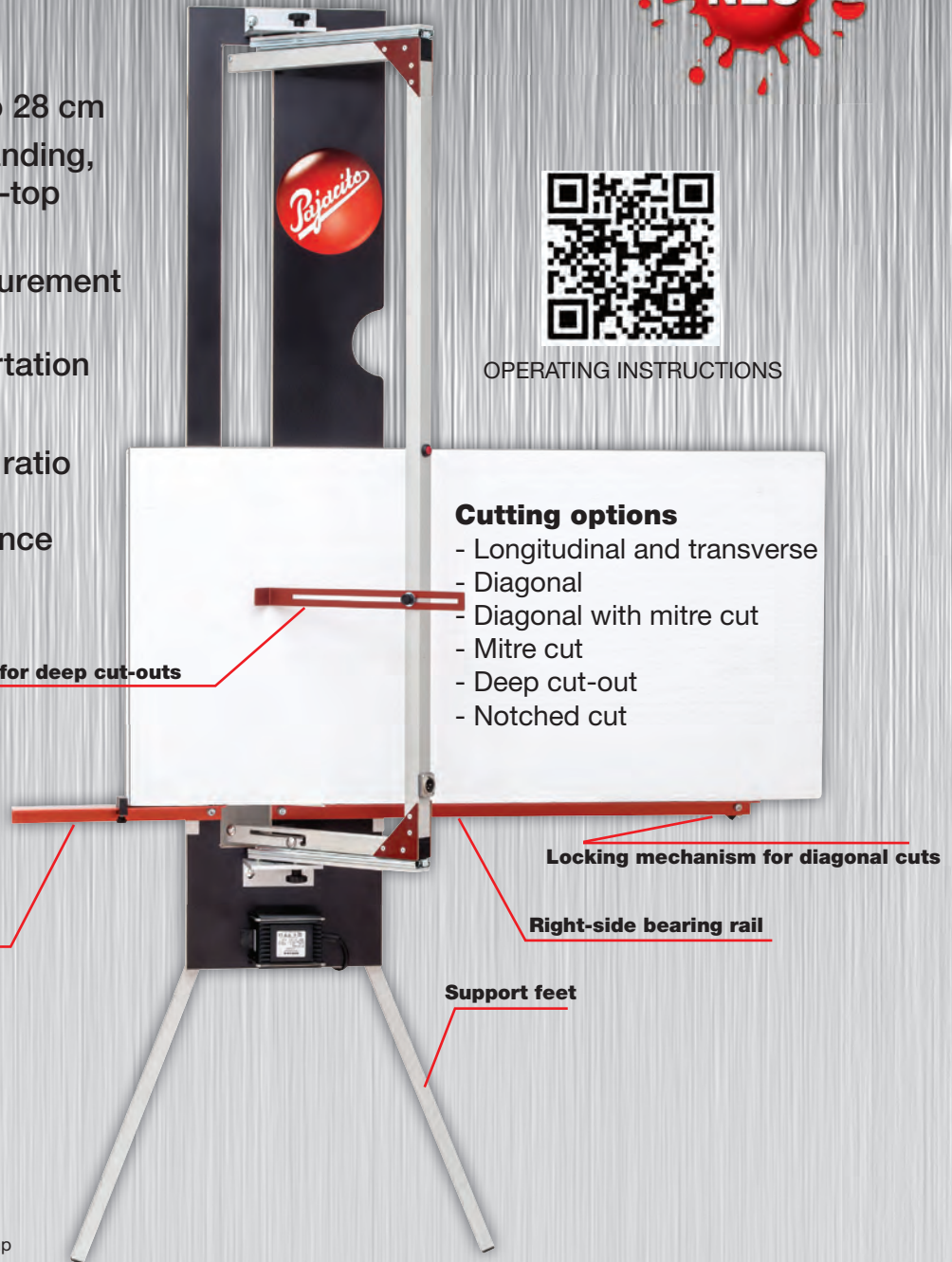

### Cutting options

- Longitudinal and transverse
- Diagonal
- Diagonal with mitre cut
- Mitre cut
- Deep cut-out
- Notched cut



### The Pajarito Quick Cut-Multi

- Rapid and secure due to scaffold clamp
- Fold-out feet

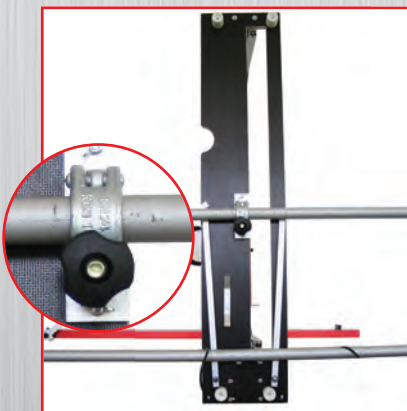

## Quick Cut-Multi 1890

### The new Pajarito Quick Cut-Multi

Convinces on account of its 2 fold-out bearing rails and feet. At the same time, the appliance is rounded-off with a limit stop for deep cut-outs and a locking mechanism for diagonal cuts.

Length of cut: 100 cm

Depth of cut at 90°: 28 cm

Length of cut at 45°: 20 cm

| Item No           | EAN*   | Dimensions    | Qty |
|-------------------|--------|---------------|-----|
| 1890              | 029328 | 132 x 26,5 cm | 1   |
| <b>Spare wire</b> |        |               |     |
| 1881E             | 029298 | Spare wire    | 1   |

### The Pajarito Quick Cut-Multi

- Rapid and secure thanks to transportation handle



# Insulating panel support

Prevents any slipping of insulating panels during the adhesive hardening process

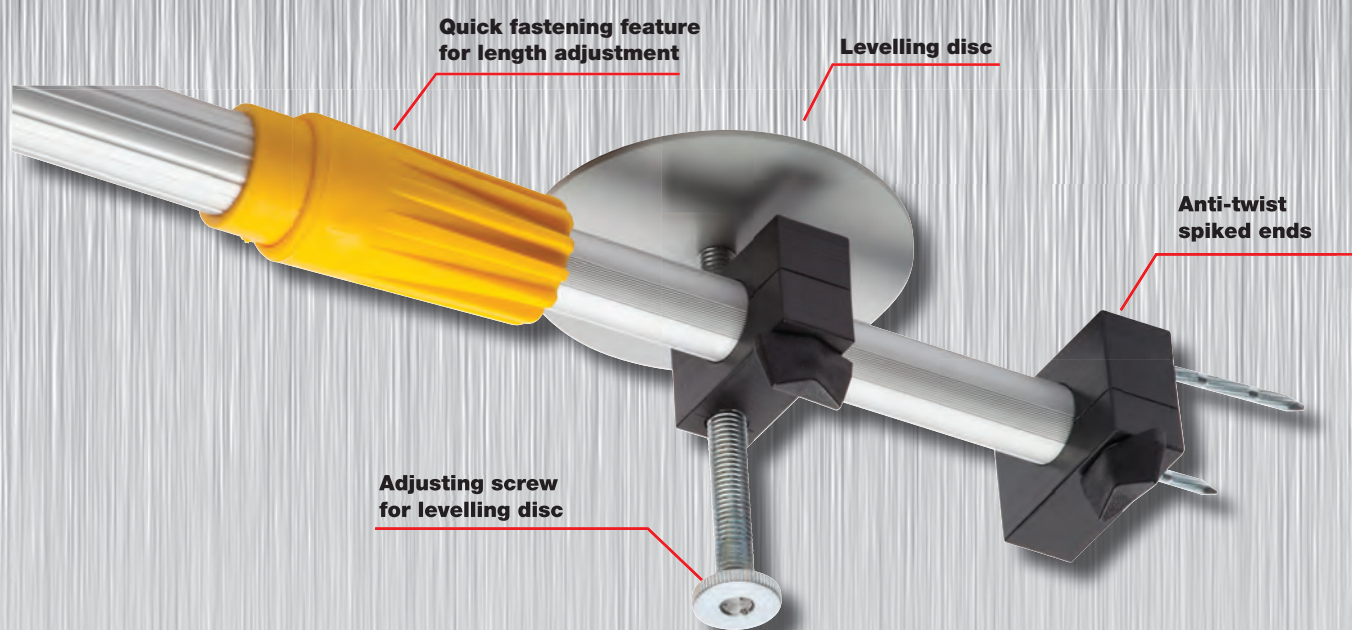

3

## Insulating panel support

Prevents any slipping of the insulating panel during the adhesive hardening process. The insulating panel support holds the insulating panels in position after application of the adhesive and can be adjusted continuously to suit every reveal width. It can be used with all types of insulating material such as e.g. EPS, mineral wool or even calcium silicate – both indoors as well as outdoors. No disturbing and wobbly support systems on the window sills are necessary. Windows and doors can continue to be used. No bothersome collecting together of wooden struts or other support material at the building site.

**A complete, neat and professional approach to every building site needing to fit insulating material!**



| Insulating panel support |        |                 |     |
|--------------------------|--------|-----------------|-----|
| Item No.                 | EAN*   | Dimensions      | Qty |
| 1800/130                 | 032700 | 80 cm - 130 cm  | 1   |
| 1800/200                 | 032717 | 105 cm - 200 cm | 1   |

# Tyler, glazier and dry construction tools

Our highlight product: **PAJARITO Universal board cutter** for strips and circles

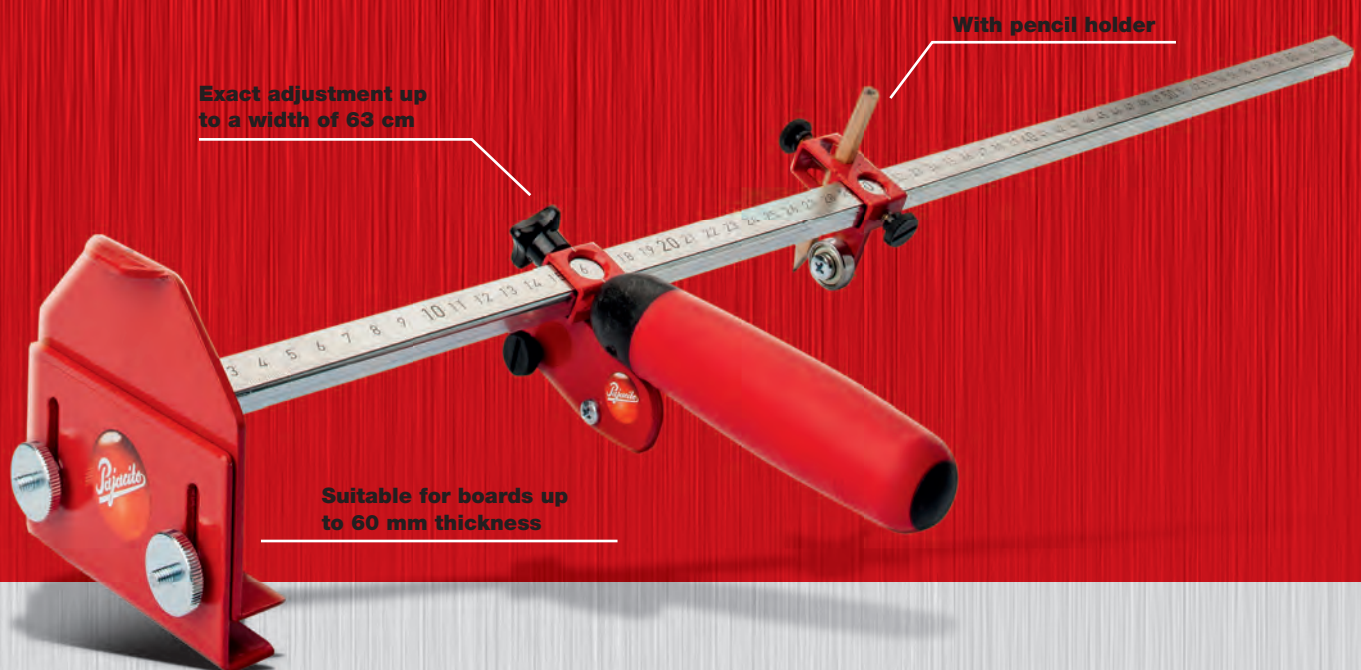

4

Best of Pajarito! The new universal cutter makes light work of precise cutting and marking of strips and circles on plaster boards and glass reinforced polystyrene PU boards!

For strips simply adjust the thickness up to 60 mm and the cutting or marking width up to 63 cm. By turning the thickness adjustment support, the strip cutter becomes a compass for cutting circles up to 126 cm. And all with maximum precision. Made in Germany – Made by Pajarito.

The **PAJARITO** Universal board cutter can be found on page 112.



Mixers from page 108



Dispensing guns from page 110



Taping knives on page 113



Epoxy grout float on page 116

# Quality of work.

We demand the highest standards for our work. Because we know that you have high expectations of us. Let's stay together successfully.

**Pajarito: A quality label. Since 1923.**

**III Made in Germany**



**III Made in Germany  
Made by Pajarito**

**One mixing paddle for anything!**

Fast, clean and 100% homogenous!

**Mixer**

Zinc-plated steel, for use with power drills, with angular mixing basket, shaft diameter 10 mm, diameter of the mixing basket 125 mm.

| Item No | EAN*   | Dimensions | Qty |
|---------|--------|------------|-----|
| 348     | 103486 | 540 mm     | 1   |

4



**III Made in Germany  
Made by Pajarito**

**Basket mixer**

Zinc-plated steel, for use with power drills, shaft diameter 10 mm, with oval mixing basket, diameter of the mixing basket 140 mm.

| Item No | EAN*   | Dimensions | Qty |
|---------|--------|------------|-----|
| 345     | 103455 | 600 mm     | 1   |



**III Made in Germany  
Made by Pajarito**

**Ring mixer**

Zinc-plated steel, for use with power drills, shaft diameter 10 mm, mixing basket with ring, diameter 100 mm.

| Item No | EAN*   | Dimensions | Qty |
|---------|--------|------------|-----|
| 346     | 103462 | 490 mm     | 1   |



**III Made in Germany  
Made by Pajarito**

**Mixer**

Zinc-plated steel, for use with power drills, shaft diameter 8 mm, with 2 cross-over rings of 50 mm diameter.

| Item No | EAN*   | Dimensions | Qty |
|---------|--------|------------|-----|
| 351S    | 135265 | 430 mm     | 1   |

Please note: image scale of products may vary.

**Twin-blade mixer**

Zinc-plated steel, with two counter-acting mixing blade wheels. For any paints, spackling compounds, resin plasters, adhesives, pastes, leveling compounds, mineral plasters, mortars, etc.

| Item No | EAN*   | Diameter x length | Qty |
|---------|--------|-------------------|-----|
| 629/5   | 562900 | 55 x 350 mm       | 1   |
| 629/8   | 562917 | 80 x 350 mm       | 1   |
| 629/10  | 562924 | 100 x 500 mm      | 1   |
| 629/12  | 562931 | 120 x 500 mm      | 1   |

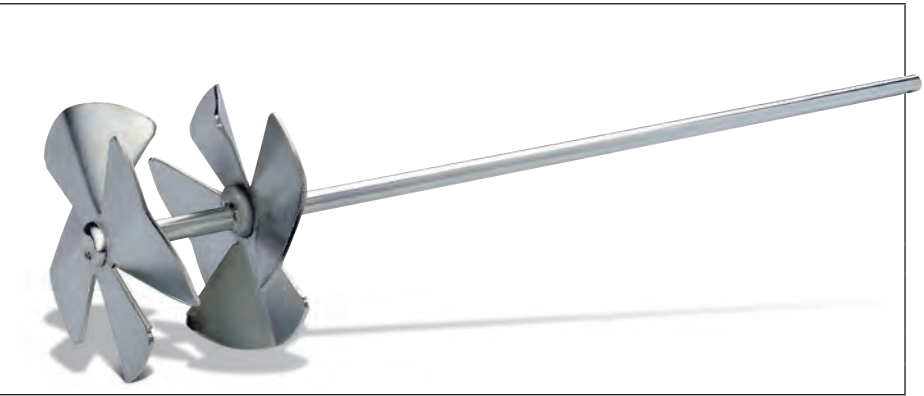

**Spiral mixing paddles**

Zinc-plated steel, for use with power drills, hexagonal shaft, for wallpaper paste, paints and other liquid material.

| Item No | EAN*   | Shaft-Ø x Ø x L   | Qty |
|---------|--------|-------------------|-----|
| 626/8   | 562610 | 8 x 80 x 400 mm   | 1   |
| 626/10  | 562627 | 10 x 100 x 600 mm | 1   |



**Mixing paddle**

For use with power drills. Item No 8626/6 with zinc-plated round steel shaft. Standard version. Version Item No 8626/8 and Item No 8626/10 with hexagonal shaft completely powder-coated.

| Item No | EAN*   | Shaft-Ø x Ø x L   | Qty |
|---------|--------|-------------------|-----|
| 8626/6  | 630791 | 6 x 60 x 350 mm   | 1   |
| 8626/8  | 630807 | 8 x 60 x 400 mm   | 1   |
| 8626/10 | 630852 | 10 x 100 x 600 mm | 1   |

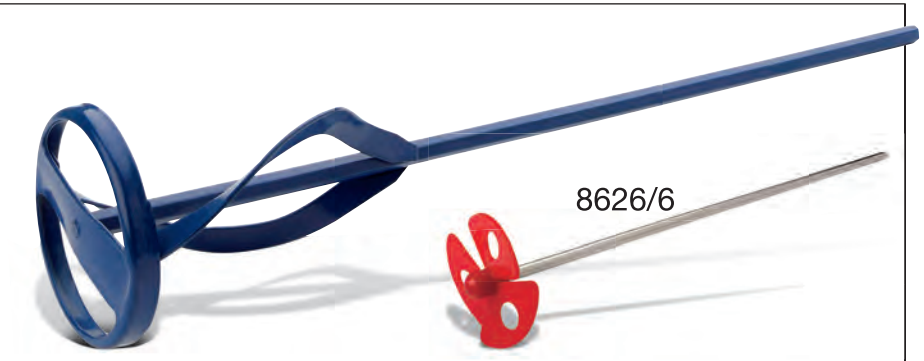

# Plaster paddles

**Plaster paddle**

Zinc-plated steel, for use with power drills, hexagonal shaft, 13 mm, for viscous materials such as powder based adhesives, ready-mix mortar, etc.

| Item No | EAN*   | Diameter x length | Qty |
|---------|--------|-------------------|-----|
| 624     | 506249 | 120 x 600 mm      | 1   |

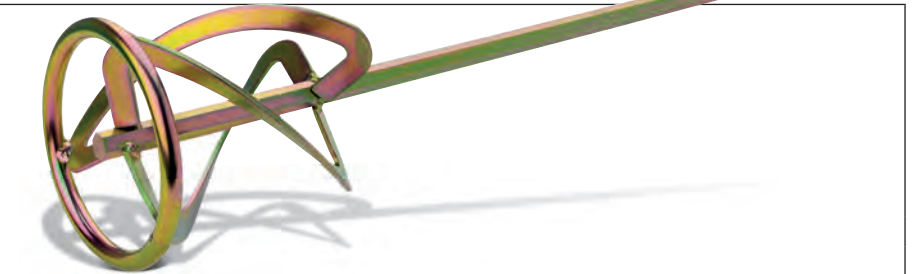

**Plaster paddle**

As Item No 624, but with round shaft, 14 mm diameter and M14 thread connection.

| Item No | EAN*   | Diameter x length | Qty |
|---------|--------|-------------------|-----|
| 625/14  | 562504 | 140 x 600 mm      | 1   |
| 625/16  | 562511 | 160 x 600 mm      | 1   |

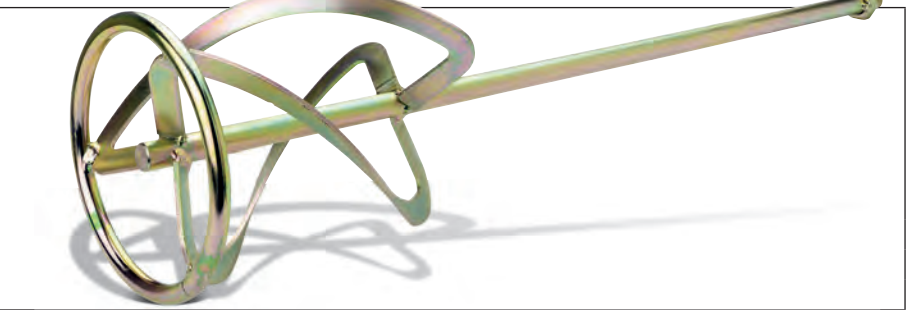

# Precision for professionals



**Sealant gun**  
Professional tool with ball-bearings for tireless and precise work, twistable cage, automatic de-pressurisation and adapting to holding angle. Particularly good for very tough compounds, like injection mortar. Geared 29:1. To be used with 310 ml cartridges.

| Item No | EAN*   | Qty |
|---------|--------|-----|
| 971     | 003946 | 1   |



**Sealant gun**  
Light alloy barrel, enclosed, 25 cm long, twistable, round push-rod, round push-rod, very sturdy pressure mechanism. Complete with plastic jet, plastic front-cap, for use with sealants in cartridges or bags, volume 320 ml.

| Item No | EAN*   | Qty |
|---------|--------|-----|
| 964     | 596486 | 1   |

**Sealant gun (no illustration)**  
As Item No 964, but with 37 cm long cylinder, volume 600 ml.

|       |        |   |
|-------|--------|---|
| 964NB | 596400 | 1 |
|-------|--------|---|



**Sealant gun**  
Very robust and well-made gun for very tough compounds, easy and even work through two bearings, push-rod with ladder-hook and extra hardened push-plate, twistable case. Gearing: 17:1. To be used with 320 ml cartridges.

| Item No | EAN*   | Qty |
|---------|--------|-----|
| 71962P  | 021179 | 12  |



**Sealant gun Cox**  
Skeleton type, hexagonal push-rod, for cartridges up to 320 ml.

| Item No | EAN*   | Qty |
|---------|--------|-----|
| 962P    | 596226 | 12  |



**Sealant gun**  
Skeleton type, hexagonal push-rod, for cartridges up to 320 ml, fold-out pin.

| Item No | EAN*   | Qty |
|---------|--------|-----|
| 964P    | 003878 | 12  |



**Sealant gun 'Quick Gun'**  
Quick stop function, very lightweight, takes any standard plastic cartridge with section thickness between 1 and 2,6 mm.

| Item No | EAN*   | Qty |
|---------|--------|-----|
| 968     | 015826 | 12  |

4

Please note: image scale of products may vary.

| Pneumatic sealant gun  |        |     |
|--|--------|-----|
| Pneumatic sealant gun for professionals, includes accessory set. Easy handling and adjustment. To be used for highly viscous materials like MS-polymer or glass-adhesive. Takes 600 ml bags. |        |     |
| Item No  | EAN*   | Qty |
| 969  | 017288 | 1   |



| Electric sealant gun cordless  |        |     |
|--|--------|-----|
| Electric sealant gun for professionals, cordless, 7,4 V with automatic back-flow, freely adjustable feed-rate, easy handling. Comes with hard-shell case, rechargeable battery, charger. Extrusion pressure: 300 kg. To be used with 310 ml cartridges or 400 ml bags. |        |     |
| Item No  | EAN*   | Qty |
| 970  | 017295 | 1   |



| Sealant smoother  |        |     |
|---|--------|-----|
| Highly flexible, resistant special plastic, for quick, clean and cost-effective smoothing of silicone and acrylic joints. |        |     |
| Item No   | EAN*   | Qty |
| 8115  | 670278 | 50  |



| Sealant smoothing set  |        |     |
|--|--------|-----|
| Multifunctional tool set for smoothing of different sealant compounds like silicone, acrylic, polyurethane, etc.<br>1x 180° angle, 1x 90°, 4x 45° (16/10/8/5 mm)<br>3x concave (radius: 5/10/15 mm)<br>7x convex shape<br>(30/25/20/15/10/8/6 mm x 3 mm) |        |     |
| Item No  | EAN*   | Qty |
| 71138  | 004554 | 12  |



| Foam dispensing gun   |        |     |
|---|--------|-----|
| Sturdy metal body, needle, adapter PTFE-coated. Easy clean. High quality dispensing gun for professionals. Universal adaptor for any standard PU foam cans on the market. |        |     |
| Item No   | EAN*   | Qty |
| 71561   | 026877 | 1   |



| Foam dispensing gun  |        |     |
|--|--------|-----|
| Lightweight dispensing gun with Soft-Sleeve-gasket-system. Stepped, sturdy shaft. New adjustment system allows for more precise control of the foam flow, compared to other guns. Lightweight and ergonomic handle make for easy work. |        |     |
| Item No  | EAN*   | Qty |
| 71558  | 024804 | 1   |



| Foam dispensing gun  |        |     |
|--|--------|-----|
| Lightweight plastic/metal gun, easily adjustable with extra large regulating knob, metal trigger, sturdy tool with easy handling, ergonomical handle with rubber inserts for a great grip. |        |     |
| Item No  | EAN*   | Qty |
| 71557  | 022688 | 1   |



III Made in Germany  
Made by Pajarito



**Universal cutter**

Best of Pajarito! The new universal cutter makes light work of precise cutting and marking of strips and circles on plaster boards and glass reinforced polystyrene PU boards! For strips simply adjust the thickness up to 60 mm and the cutting or marking width up to 63 cm. By turning the thickness adjustment support, the strip cutter becomes a compass for cutting circles up to 126 cm. And all with maximum precision.  
Made in Germany – Made by Pajarito.

| Item No | EAN*   | Dimensions | Qty |
|---------|--------|------------|-----|
| 441     | 029175 | 640 mm     | 1   |

4

III Made in Germany  
Made by Pajarito



**Plaster board cutter**

Zinc-plated steel, with measuring scale, two high quality special steel serrated wheels, 38 mm diameter, curved wooden handle, adjustable wooden cutting guide, for strip cutting of plasterboard, maximum cutting width 120 mm.

| Item No | EAN*   | Dimensions | Qty |
|---------|--------|------------|-----|
| 633     | 106333 |            | 1   |

**Spare serrated cutting wheels**

High quality special steel beveled, serrated edge.

|      |        |       |   |
|------|--------|-------|---|
| 633E | 506331 | 38 mm | 1 |
|------|--------|-------|---|

III Made in Germany  
Made by Pajarito



**Stucco saw**

Hardened, polished spring band steel, 1.3 mm thick, coarse serration, angled wooden handle.

| Item No | EAN*   | Dimensions | Qty |
|---------|--------|------------|-----|
| 636     | 106364 | 330 mm     | 3   |

III Made in Germany  
Made by Pajarito



**Sash (compass) saw**

Induction-hardened blade, set teeth, wooden handle, for cut-outs in plasterboards.

| Item No | EAN*   | Dimensions | Qty |
|---------|--------|------------|-----|
| 259/16  | 502593 | 295 mm     | 12  |

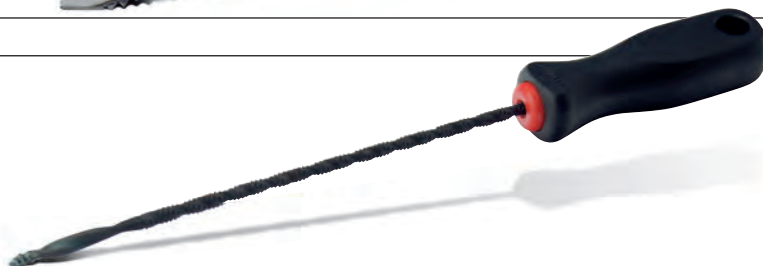

**Auger-reamer**

Hardened steel, drill tip, spiral channel cutting shaft, plastic handle, for drilling and extending openings and cut-outs in plasterboard.

| Item No | EAN*   | Dimensions | Qty |
|---------|--------|------------|-----|
| 647     | 504986 | 270 mm     | 6   |

Please note: image scale of products may vary.

**Taping knife, with bit, stainless**

Hardened, highly polished stainless spring band steel, 0.5 mm thick, stainless reinforcing plate, wooden handle, brass rivets. With inserted Phillips type bit in the handle end.

III Made in Germany  
Made by Pajarito



| Item No | EAN*   | Dimensions | Qty |
|---------|--------|------------|-----|
| 634R/B  | 105053 | 150 mm     | 6   |

**Taping knife, with bit, stainless**

Hardened, highly polished stainless spring band steel, 0.5 mm thick, stainless reinforcing plate, soft-grip handle, brass rivets. With inserted Phillips type bit in the handle end.



| Item No | EAN*   | Dimensions | Qty |
|---------|--------|------------|-----|
| 5634R   | 004486 | 150 mm     | 12  |

**Taping knife, wide**

Hardened, highly polished stainless spring band steel, 0.5 mm thick, stainless steel spine reinforcing plate, wooden handle, visible blade height 76 mm.

III Made in Germany  
Made by Pajarito



| Item No | EAN*   | Dimensions | Qty |
|---------|--------|------------|-----|
| 635R/20 | 163541 | 200 mm     | 6   |
| 635R/25 | 163510 | 250 mm     | 6   |
| 635R/30 | 163527 | 300 mm     | 6   |

**Drywall trowel, stainless**

Hardened, polished, stainless chromium steel blade, long light-alloy mounting, ergonomically shaped soft plastic handle. Rounded corners and slightly concave blade for economical sparking of panel butt-joints.

III Made in Germany  
Made by Pajarito



| Item No | EAN*   | Blade dimensions   | Qty |
|---------|--------|--------------------|-----|
| 865R    | 505075 | 305 x 120 x 0,6 mm | 4   |

**Plaster pan, stainless**

Stainless steel, 1mm thick.

III Made in Germany  
Made by Pajarito



| Item No | EAN*   | Outer dimensions  | Qty |
|---------|--------|-------------------|-----|
| 638R    | 105060 | 350 x 105 x 78 mm | 5   |

**Board carriers**

Zinc-plated round steel, rubber sheathing, for carrying plasterboards, wooden or plastic, etc. Packed in pairs.

III Made in Germany  
Made by Pajarito



| Item No   | EAN*   | Dimensions | Qty |
|---|--------|------------|-----|
| 842B  | 184232 | 70 mm      | 1   |
| <b>Spare rubber sheathing (no illustration)</b> |        |            |     |
| 842B/E  | 184249 | 70 mm      | 3   |



# Precision for professionals



**Edge planer**  
Plastic, with 2 exchangeable blades. For beveling plasterboard panels.

| Item No    | EAN*   | Dimensions | Qty |
|------------|--------|------------|-----|
| <b>642</b> | 504962 | 230 mm     | 1   |

**Spare blades (no illustration)**  
Hardened steel, trapezoid, double beveled edge.

|               |        |  |    |
|---------------|--------|--|----|
| <b>642E/1</b> | 504979 |  | 10 |
|---------------|--------|--|----|

**Spare blades (no illustration)**  
Hardened steel, trapezoid, beveled on two sides

|               |        |  |    |
|---------------|--------|--|----|
| <b>642E/2</b> | 505099 |  | 10 |
|---------------|--------|--|----|



**Made in Germany**

**Compact bolt cutter**  
Forged steel, original Knipex quality, plastic sheathed handle grips, for bolts up to 4 mm diameter.

| Item No    | EAN*   | Dimensions | Qty |
|------------|--------|------------|-----|
| <b>649</b> | 505068 | 200 mm     | 1   |



**Punch-lock riveter**  
Hardened sheet steel, plastic sheathed handle grips, exchangeable blade. For trouble-free fixing of steel frame profiles (channels) up to 1.2 mm (or 2x 0.6 mm) thickness.

| Item No    | EAN*   | Dimensions | Qty |
|------------|--------|------------|-----|
| <b>644</b> | 504993 | 350 mm     | 1   |

**Spare blade (no illustration)**

|             |        |  |   |
|-------------|--------|--|---|
| <b>644E</b> | 505013 |  | 1 |
|-------------|--------|--|---|

**Spare die (no illustration)**

|              |        |  |   |
|--------------|--------|--|---|
| <b>644EM</b> | 505020 |  | 1 |
|--------------|--------|--|---|



**Sheet metal nibbler**  
Hardened sheet steel, plastic sheathed handle grips, exchangeable serrated blade and shaving deflector. For precision, burr- and distortion-free cutting of various kinds of sheet metal up to 1.2 mm thickness.

| Item No    | EAN*   | Dimensions | Qty |
|------------|--------|------------|-----|
| <b>643</b> | 505037 | 280 mm     | 1   |

**Spare blade (no illustration)**

|             |        |  |   |
|-------------|--------|--|---|
| <b>643E</b> | 505044 |  | 1 |
|-------------|--------|--|---|

**Spare die (no illustration)**

|              |        |  |   |
|--------------|--------|--|---|
| <b>643EM</b> | 505051 |  | 1 |
|--------------|--------|--|---|

Please note: image scale of products may vary.

# Patented marking assistance



## Pajarito centring device

Centring device for dry construction. Useful tool to find and mark the centre of flush-mounted boxes on the panel to be fitted or the tile to be laid. Fit the correct size centring device in the box, trial fit the panel or tile and the device leaves a mark or an indentation on the back, which is the centre for the hole cutter.

### 699 set consists of:

4x device for flush-boxes 90 x 20 mm  
1x device for distribution boxes 90 x 14 mm

### 699F set consists of:

as Item No 699  
plus ink stamp set for tiles

| Item No | EAN*   |                  | Qty |
|---------|--------|------------------|-----|
| 699     | 017370 | Dry construction | 1   |
| 699F    | 017851 | Tiles            | 1   |

Art.-Nr 699



III Made in Germany  
Made by Pajarito

Art.-Nr 699F



## Grouting squeegee

Zinc-plated metal holder, riveted-on pole socket, twin microcellular rubber blade, 20 mm thick.

| Item No | EAN*   | Dimensions | Qty |
|---------|--------|------------|-----|
| 197M/45 | 519706 | 450 mm     | 10  |
| 197M/55 | 419716 | 550 mm     | 6   |



## Tile washing bucket

Settling of suspended matter (mortar) is permitted by the sloping contour at the back, with a large radius in the rear bottom to remove sediment without any problems. The long construction of the bucket facilitates insertion of the wash-down float, while simultaneously scraping on the two stripper rolls. Includes wash-down float (Item No 328).

includes  
bottom grid

| Item No | EAN*   |  | Qty |
|---------|--------|--|-----|
| 820     | 017301 |  | 1   |



## Tile wedges

Beechwood, 1.5 x 7 x 55 mm  
250 pieces in a bag.

| Item No | EAN*   |  | Qty |
|---------|--------|--|-----|
| 822     | 017325 |  | 1   |



## Stripper roll

Plastic roll, 180 mm long, 40 mm diameter, zinc-plated frame, 5 mm round steel, for any bucket rim.

III Made in Germany  
Made by Pajarito

| Item No | EAN*   |  | Qty |
|---------|--------|--|-----|
| 828     | 108283 |  | 4   |



**III Made in Germany  
Made by Pajarito**



**Rubber spatula**  
Stiff rubber blade, 5 mm thick, waxed wooden handle, 40 mm high.

| Item No       | EAN*   | Dimensions  | Qty |
|---------------|--------|-------------|-----|
| <b>399/12</b> | 139911 | 120 x 60 mm | 6   |
| <b>399/20</b> | 139928 | 200 x 60 mm | 6   |
| <b>399/25</b> | 139935 | 250 x 60 mm | 6   |



**Rubber spatula**  
Rubber blade, 4 mm thick, wooden handle, 37 mm high, Standard version.

| Item No     | EAN*   | Dimensions  | Qty |
|-------------|--------|-------------|-----|
| <b>8399</b> | 739906 | 200 x 35 mm | 6   |

**III Made in Germany  
Made by Pajarito**



**Rubber spatula, light coloured**  
Rubber blade, 4 mm thick, wooden handle, 55 mm high, Standard version.

| Item No        | EAN*   | Dimensions  | Qty |
|----------------|--------|-------------|-----|
| <b>8397/20</b> | 681106 | 200 x 45 mm | 6   |
| <b>8397/25</b> | 681274 | 250 x 45 mm | 6   |



**Epoxy grout float**  
Stainless steel plate, 1 mm thick, wooden handle, beveled, special rubber pad, 12 mm thick.

| Item No    | EAN*   | Dimensions  | Qty |
|------------|--------|-------------|-----|
| <b>398</b> | 139805 | 255 x 95 mm | 2   |



**Wash-down float**  
Plastic backing plate, 5 mm thick, offset plastic handle, bonded-on highly absorbent synthetic sponge pad, 30 mm thick, with grid pattern grooves.

| Item No   | EAN*   | Dimensions   | Qty |
|---|--------|--------------|-----|
| <b>328</b>  | 503248 | 280 x 140 mm | 5   |
| <b>Spare pads (no illustration)</b><br>Highly absorbent synthetic sponge pad, 30 mm thick, with grid pattern grooves. |        |              |     |
| <b>328E</b>   | 503255 | 300 x 150 mm | 5   |



**Tile grout sponges**  
High quality, durable, absorbent artificial foam.

| Item No    | EAN*   | Dimensions        | Qty |
|------------|--------|-------------------|-----|
| <b>190</b> | 501909 | 180 x 120 x 60 mm | 12  |



**Tile grout sponges**  
High quality, durable, absorbent artificial foam. Standard version.

| Item No     | EAN*   | Dimensions        | Qty |
|-------------|--------|-------------------|-----|
| <b>8190</b> | 701903 | 180 x 120 x 60 mm | 12  |

Please note: image scale of products may vary.

| <b>Epoxy tile grout scrubber</b>   |        |              |     |
|--|--------|--------------|-----|
| Expanded plastic backing plate, bonded-on hook and loop tape, one of each scrubbing pad (Item No 193E/1) and cleaning fleece (Item No 193E/2). |        |              |     |
| Item No  | EAN*   | Dimensions   | Qty |
| 193  | 519300 | 230 x 110 mm | 1   |
| <b>Scrubbing pad</b>   |        |              |     |
| Hard, 10 mm thick.   |        |              |     |
| 193E/1   | 519317 | 250 x 115 mm | 6   |
| <b>Cleaning fleece</b>   |        |              |     |
| Soft, 20 mm thick.   |        |              |     |
| 193E/2   | 519324 | 250 x 115 mm | 6   |
| <b>Backing plate</b>   |        |              |     |
| Plastic, bonded-on hook and loop tape.   |        |              |     |
| 193H   | 519294 | 230 x 110 mm | 5   |

III Made in Germany  
Made by Pajarito



| <b>HUFA tile cutter</b>   |        |                |     |
|---|--------|----------------|-----|
| Lower refractive device, hinged pad holder, carry handle in the wooden board and stop angle in wood for the diagonal cut. Equipped with 20 mm carbide wheels. |        |                |     |
| Item No   | EAN*   | Cutting length | Qty |
| 316   | 531609 | 630 mm         | 1   |
| <b>Spare carbide wheel (no illustration)</b>  |        |                |     |
| 316E  | 531616 | 20 mm          | 1   |



| <b>Tile hole cutter</b> |        |  |     |
|-------------------------|--------|--|-----|
| Maximum 330 tiles.      |        |  |     |
| Item No                 | EAN*   |  | Qty |
| 821                     | 301318 |  | 1   |

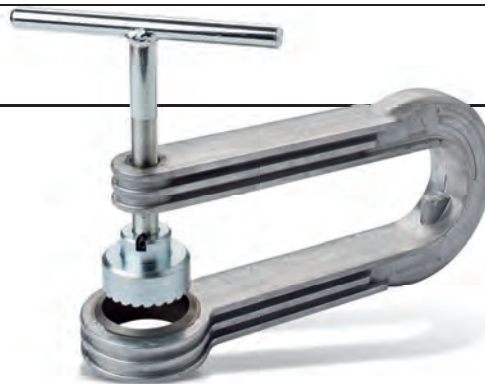

| <b>Tile hole nippers</b>                                      |        |            |     |
|---|--------|------------|-----|
| Forged steel, black lacquered, polished head, 6mm head width. |        |            |     |
| Item No   | EAN*   | Dimensions | Qty |
| 208   | 502081 | 200 mm     | 6   |



| <b>Tile hammer</b>                            |        |        |     |
|---|--------|--------|-----|
| Forged, black lacquered, carbide-tipped head. |        |        |     |
| Item No                                       | EAN*   | Weight | Qty |
| 817H  | 571711 | 50 g   | 6   |

III Made in Germany  
Made by Pajarito



# Glassy quality



| Genuine 'Silberschnitt' glass cutter                       |        |  |     |
|--|--------|--|-----|
| Wooden handle, 6 cutting wheels (Item No 154E).            |        |  |     |
| Item No  | EAN*   |  | Qty |
| 154  | 515401 |  | 12  |
| Spare wheels (no illustration)                             |        |  |     |
| Suitable for (Item No 154), 60 pcs (5x 12) in plastic box. |        |  |     |
| 154E   | 515425 |  | 1   |



Made in Germany  
Made by Pajarito

| Putty removing knife  |        |  |     |
|---|--------|--|-----|
| Hardened full-tang blade, 90 mm long, leather grips, twice riveted. |        |  |     |
| Item No   | EAN*   |  | Qty |
| 55  | 105503 |  | 12  |



Made in Germany  
Made by Pajarito

| Putty knife  |        |  |     |
|--|--------|--|-----|
| Stiff, double-edged blade, 90 mm long, curved wooden handle. |        |  |     |
| Item No  | EAN*   |  | Qty |
| 21   | 100218 |  | 12  |



Made in Germany  
Made by Pajarito

EDELSTAHL  
Rost  
frei

| Putty knife, stainless  |        |  |     |
|---|--------|--|-----|
| Polished, stiff, double-edged, full-tang stainless steel blade, 93 mm long, triple riveted fine-wood grips. |        |  |     |
| Item No   | EAN*   |  | Qty |
| 22R   | 522003 |  | 12  |



Made in Germany  
Made by Pajarito

EDELSTAHL  
Rost  
frei

| Putty knife, stainless  |        |  |     |
|---|--------|--|-----|
| Polished, stiff, double-edged, full-tang, curved stainless steel blade, 95 mm long, triple riveted fine-wood grips. |        |  |     |
| Item No   | EAN*   |  | Qty |
| 34R   | 534006 |  | 12  |



Made in Germany  
Made by Pajarito

| Putty knife, Swiss style  |        |            |     |
|---|--------|------------|-----|
| Polished, stiff blade, 75 mm long, double riveted fine-wood handle. |        |            |     |
| Item No   | EAN*   | Dimensions | Qty |
| 37/20   | 103721 | 20 mm      | 12  |

4

Please note: image scale of products may vary.

# Get a grip

## Glass pane lifter

Cast aluminium, with 2 suction cups, rubber pads with pump lever. Capacity approx. 65 kg.

| Item No | EAN*   | Qty |
|---------|--------|-----|
| 560     | 556008 | 1   |

## Glass pane lifter

Cast aluminium, with 3 suction cups, rubber pads with pump lever. Capacity approx. 110 kg.

|     |        |   |
|-----|--------|---|
| 561 | 505617 | 1 |
|-----|--------|---|

## Spare rubber pad (no illustration)

Fits Item Nos 560 and 561, with pump lever.

|      |        |   |
|------|--------|---|
| 560E | 556015 | 1 |
|------|--------|---|



Item No 560



Item No 561

## Putty knife

Stiff, double-edged blade, wooden handle. Standard version.

| Item No | EAN*   | Qty |
|---------|--------|-----|
| 8020    | 300328 | 12  |



## Glazier square

Bakelite, 5 mm thick long leg, 10 mm thick short leg. Item No 221/205 with cross tie for extra stability.

| Item No | EAN*   | Dimensions    | Qty |
|---------|--------|---------------|-----|
| 221/60  | 522058 | 600 x 300 mm  | 1   |
| 221/80  | 522065 | 800 x 350 mm  | 1   |
| 221/105 | 522072 | 1050 x 400 mm | 1   |
| 221/150 | 522089 | 1500 x 450 mm | 1   |
| 221/205 | 522096 | 2050 x 600 mm | 1   |



## Window squeegee

Stainless steel handle, exchangeable rubber blade holder, rubber blade.

| Item No | EAN*   | Dimensions | Qty |
|---------|--------|------------|-----|
| 654R/35 | 565420 | 350 mm     | 10  |

## Spare rubber blade (no illustration)

|         |        |        |    |
|---------|--------|--------|----|
| 654E/35 | 565468 | 350 mm | 10 |
|---------|--------|--------|----|



## Strip washer

Aluminium tube, hollow plastic handle, includes plush-woven fabric cover.

| Item No | EAN*   | Dimensions | Qty |
|---------|--------|------------|-----|
| 654S/35 | 565482 | 350 mm     | 6   |

## Spare cover (no illustration)

Plush-woven fabric.

|          |        |        |   |
|----------|--------|--------|---|
| 654SE/35 | 565505 | 350 mm | 6 |
|----------|--------|--------|---|





## Quality out of conviction

**Performance and excellence, quality awareness and long-term considerations: that is also the world of Pajarito.**

Everywhere where top quality work needs to be performed, high quality tools are also at hand. And that is the reason why we only sell products that we are convinced about ourselves and in a quality that we are proud of. Products you can rely on – without any exception. Our quality awareness is the result of a passion for customer-oriented innovations and long-term considerations. We know that we are only able to

satisfy the highest demands through permanent improvements. And that is exactly what drives us to highest performances – time and again.

**Tools from Pajarito: quality in every detail.**

# Floor laying tools

Our highlight product: **PAJARITO Chamfer King** quickly cuts straight edges



Best of Pajarito! The crowning glory of your design flooring installation: The new Chamfer-King ensures that lower edges chamfer cleanly and items are accurately planed to one tenth precision dimensions - in one and the same holder position without the need for any change. This small tool fits comfortably in your hand, the integrated industrial blade also cuts rigid coverings effortlessly and perfectly clean. Blade change and adjustment take less than a minute. Made in Germany – Made by Pajarito.

You can find the **PAJARITO Chamfer King** on page 137.



Screed spreaders from page 122



Knee pads on page 126



Straight edges on page 127



Pressure rollers from page 137

# Widespread work

III Made in Germany  
Made by Pajarito



### Large area screed spreader, height adjustable

Hardened, highly polished, stainless spring band steel, u-shaped stainless steel reinforcement, plywood handle, with socket (Item No 657). The blade clamps accept notched blades of 560 mm length with any notch style. In addition the spreader is height adjustable by means of two pins for settings to any application height up to 36 mm.

| Item No | EAN*   | Dimensions | Qty |
|---------|--------|------------|-----|
| 679     | 001867 | 560 mm     | 4   |

III Made in Germany  
Made by Pajarito



### Pajarito large surface scraper

Aluminium, 60 cm width, 6 hardened scraping brads, pole socket. For application and spreading of coatings and fillers with height adjustable stainless steel blade. The setting blade is infinitely variable up to 13 mm length.

| Item No | EAN*   | Dimensions | Qty |
|---------|--------|------------|-----|
| 4680K   | 018513 | 60 cm      | 1   |

### Pajarito control strip for Item No 4680K

For an exact and quick parallel setting of the large surface scraper. Height settings: 1 mm, 1.2 mm, 1.4 mm, 1.6 mm, 1.8 mm und 2 mm.

|       |        |       |   |
|-------|--------|-------|---|
| 4680L | 018520 | 52 cm | 1 |
|-------|--------|-------|---|

5



III Made in Germany  
Made by Pajarito



### Finishing spreader

PAJAQUICK, with height adjustment.

Model and dimensions see pages 32 and 33. Two infinitely adjustable gliders allow application settings from 6 - 30 mm.

| Item No | EAN* | Dimensions | Qty |
|---------|------|------------|-----|
| 7656R   |      |            |     |

III Made in Germany  
Made by Pajarito



### Wallpaper stripper

0,4 mm hardened and polished spring steel blade, dimension 600 mm, 40 mm plywood handle with curved grip

| Item No  | EAN*   | Dimensions | Qty |
|----------|--------|------------|-----|
| 8655Z/60 | 018308 | 600 mm     | 6   |

Please note: image scale of products may vary.

| Floor spreader                                  |        |            |     |
|---|--------|------------|-----|
| Hardened, polished steel, angled wooden handle. |        |            |     |
| Item No   | EAN*   | Dimensions | Qty |
| 675A  | 267508 | 330 mm     | 5   |
| 675B  | 267515 | 430 mm     | 5   |
| 675C  | 267522 | 530 mm     | 5   |



| Leveling spreader, stainless   |        |            |     |
|--|--------|------------|-----|
| Hardened, highly polished stainless spring band steel, 0.7 mm thick, 115 mm width, 40 mm high wooden handle. The level stop edge is fixed with 2 castle-nuts and wing-nuts for infinitely adjusting from 2 to 15 mm. |        |            |     |
| Item No  | EAN*   | Dimensions | Qty |
| 678R   | 100676 | 280 mm     | 6   |



| Large area screed spreader, stainless  |        |        |     |
|--|--------|--------|-----|
| Hardened, highly polished stainless spring band steel blade and blade clamp, U-shaped stainless steel blade stiffener plywood handle with mounting socket (Item No 657). The blade clamp accepts 2 notched blades of 280 mm length, side by side, with any notch style. Notched blades (Item No 777E/56) are used for self-leveling compounds. |        |        |     |
| Item No  | EAN*   | Dim.   | Qty |
| 676  | 106760 | 560 mm | 6   |
| Notched blades   |        |        |     |
| Tough, special steel, especially abrasion resistant, 0.5 mm thick, 560 mm long, with notch styles TKB R1, TKB R2, TKB R3. Further notched blades see pages 44/45.  |        |        |     |
| 777E/56 TKB R1   | 005216 | 560 mm | 12  |
| 777E/56 TKB R2   | 934004 | 560 mm | 12  |
| 777E/56 TKB R3   | 005223 | 560 mm | 12  |
| 779E/56 TKB R1   | 001294 | 560 mm | 12  |
| 779E/56 TKB R2   | 019763 | 560 mm | 12  |
| 779E/56 TKB R3   | 003519 | 560 mm | 12  |

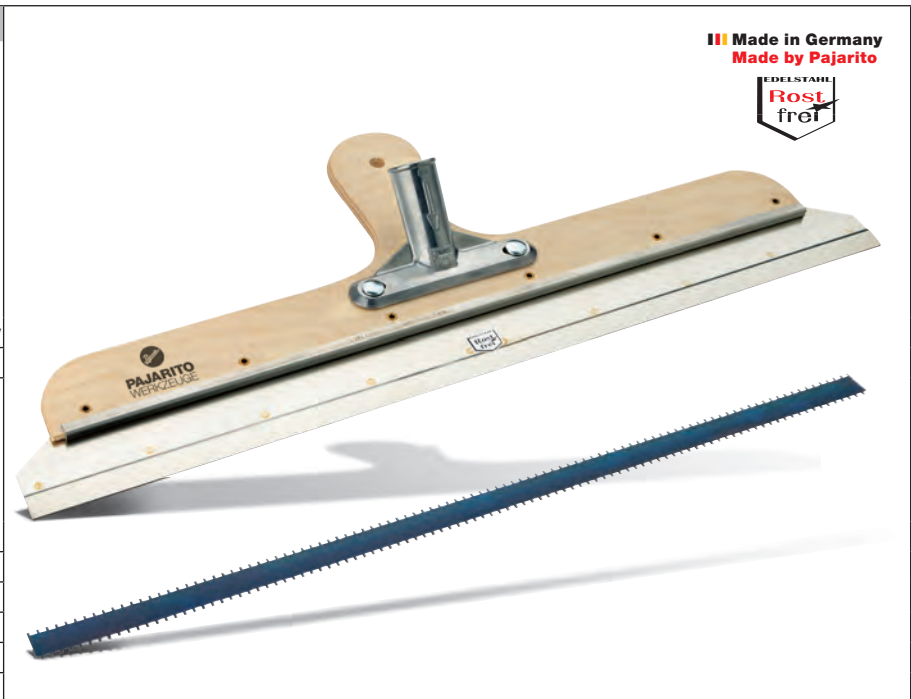

| Large area screed spreader   |        |            |     |
|--|--------|------------|-----|
| Hardened, polished spring band steel blade, 0.6 mm thick, 800 mm width, 100 mm height, 2 variable skids (Item No 677F), for even setting of screed height between 6 and 30 mm. Angled steel mounting with socket (Item No 657) for telescopic poles or wooden or steel shaft handle. |        |            |     |
| Item No  | EAN*   | Dimensions | Qty |
| 677  | 167709 | 800 mm     | 1   |
| Spare blade (no illustration)  |        |            |     |
| 677E   | 167716 | 800 mm     | 1   |
| Spare skid with twin arch<br>for placement heights of 6-30 mm  |        |            |     |
| 677F   | 167723 |            | 1   |
| Spare skid with single arch<br>for lowest placement heights down to 0 mm   |        |            |     |
| 677F/S   | 167730 |            | 1   |

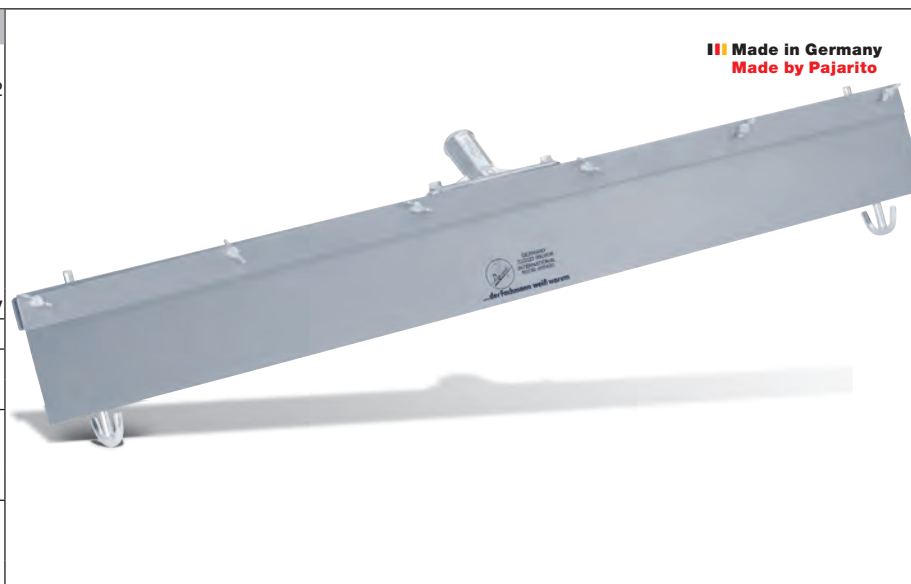

# Smoothing and sanding



III Made in Germany  
Made by Pajarito



III Made in Germany  
Made by Pajarito



III Made in Germany  
Made by Pajarito

### Mounting for large area spreaders

Holder made of powder coated square steel tube, aluminium mounting socket for telescopic poles or wooden or steel shaft handle, metal mounting strip with 5 thumbscrews. Suitable for Item Nos 677ZE and 677E/G.

| Item No | EAN*   | Qty |
|---------|--------|-----|
| 677Z/60 | 106777 | 1   |

### Spreader blades for 677Z/60

Hardened, polished spring band steel, 0.6 mm thick, 645 mm width, 100 mm height. Available with TKB notch-styles C1, C2, C3 und C4, and Pajarito notch-style 104.

An overview of notch styles can be found from page 46.

|           |        |   |
|-----------|--------|---|
| 677ZE/C2  | 100409 | 1 |
| 677ZE/C3  | 100416 | 1 |
| 677ZE/C1  | 100423 | 1 |
| 677ZE/C4  | 100430 | 1 |
| 677ZE/104 | 100454 | 1 |

### Rubber blade for 677Z/60

Rubber blade from light rubber in Shore A 60, smooth or serrated. Dim. (LxH) 650 x 55 mm.

| Item No | EAN*   | Serrated      | Qty |
|---------|--------|---------------|-----|
| 677E/G  | 004585 | 0 mm (smooth) | 1   |
| 677E/2  | 015451 | 2 mm          | 1   |
| 677E/3  | 015468 | 3 mm          | 1   |
| 677E/4  | 004592 | 4 mm          | 1   |
| 677E/5  | 015475 | 5 mm          | 1   |
| 677E/8  | 004608 | 8 mm          | 1   |
| 677E/14 | 004615 | 14 mm         | 1   |

5



### Scree hand sander

Wooden handle, trapezoid grinding stone. This form allows an unhindered sanding up to the wall. Multiple holes in the base, guarantee a particularly high abrasion, weight 1.4 kg

| Item No | EAN*   | Grit | Qty |
|---------|--------|------|-----|
| 58740   | 587408 | 20   | 1   |



### Hand grinding stone

Angular shape, 180 x 70 x 50 mm, weight 1.5 kg.

| Item No | EAN*   | Grit | Qty |
|---------|--------|------|-----|
| 876     | 508762 | 40   | 1   |

Please note: image scale of products may vary.

# Spiked rollers

**Spiked roller**  
 Plastic roller, 11 mm long spikes, nickel-plated metal frame, light-alloy, hollow handle, sizes 500 to 1000 mm have a double metal frame.

| Item No  | EAN*   | Dimensions | Qty |
|----------|--------|------------|-----|
| 4900/18  | 449027 | 180 mm     | 1   |
| 4900/25  | 449034 | 250 mm     | 1   |
| 4900/50  | 449041 | 500 mm     | 1   |
| 4900/75  | 449058 | 750 mm     | 1   |
| 4900/100 | 501466 | 1000 mm    | 1   |



**Spiked roller**  
 Plastic roller, with particularly long spikes, nickel-plated metal frame, light-alloy, hollow handle, 250 mm width.

| Item No | EAN*   | Spike length | Qty |
|---------|--------|--------------|-----|
| 4901/25 | 549086 | 21 mm        | 1   |
| 4902/25 | 549093 | 31 mm        | 1   |

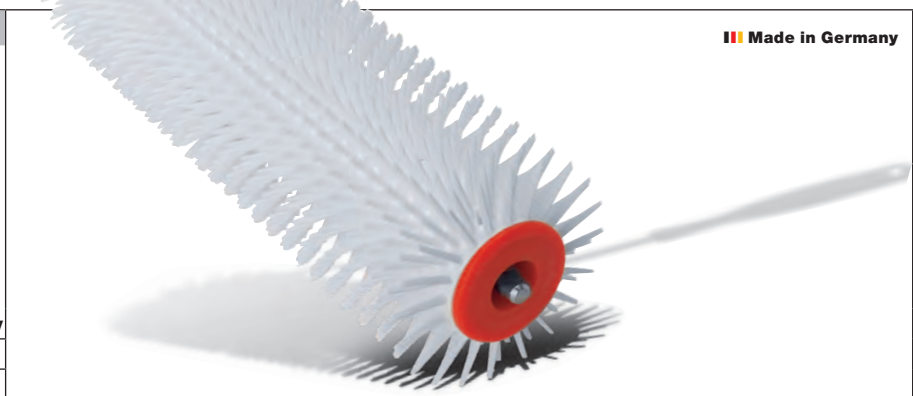

**Spiked roller**  
 Splash guard, nickel-plated metal frame. Standard version.

| Item No | EAN*   | Dim.   | Spikes | Qty |
|---------|--------|--------|--------|-----|
| 8490/25 | 632481 | 250 mm | 11 mm  | 1   |
| 8490/50 | 004295 | 500 mm | 11 mm  | 1   |
| 8490/75 | 007982 | 750 mm | 11 mm  | 1   |
| 8491/25 | 020707 | 250 mm | 21 mm  | 1   |
| 8491/50 | 020714 | 500 mm | 21 mm  | 1   |
| 8491/75 | 020721 | 750 mm | 21 mm  | 1   |
| 8492/25 | 022893 | 250 mm | 35 mm  | 1   |
| 8492/50 | 021629 | 500 mm | 35 mm  | 1   |
| 8492/75 | 026891 | 750 mm | 35 mm  | 1   |

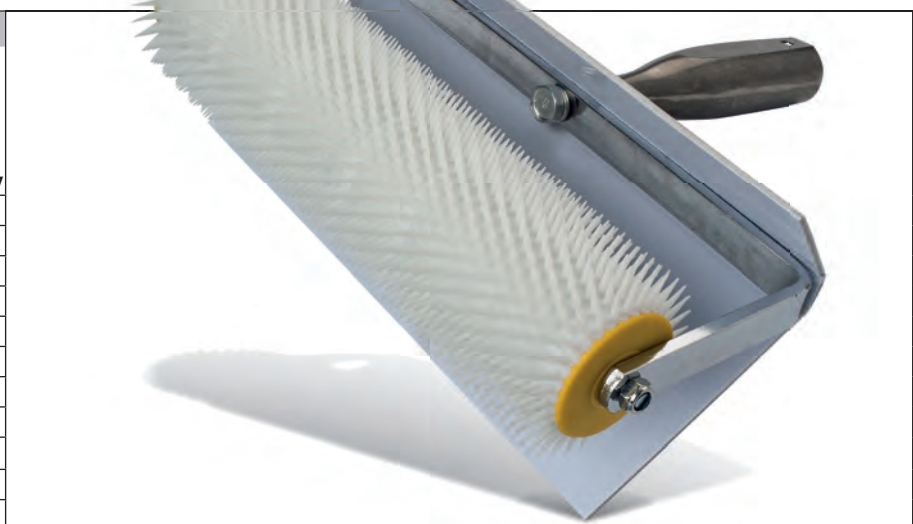



**Knee pads**

Protection zone with flexible PVC cap, adaptable through FLEX-lamellae. Sandwich shock absorber! Soft padding with elastic gel insert, elasticated straps, wide neoprene enclosure against cutting and slicing into the knees, comfortable when walking or standing, one-size hook and loop closure. Certified according to DIN EN 14404.

| Item No | EAN*   | Qty |
|---------|--------|-----|
| 909CE   | 023739 | 1   |



**Knee pads**

Black rubber, padded with durable foam rubber, elasticated straps. Manufactured according to mining DIN 23311.

| Item No | EAN*   | Qty |
|---------|--------|-----|
| 910CE   | 023876 | 1   |



**Knee pads Fento 200**

- Knees and shins are well protected
- Perfect fit
- Elasticated straps won't cut into the knee
- Prevents back and knee problems
- Comfortable and sturdy
- Light weight: 250 grams
- Flexible and 100 % waterproof
- Durable and hard-wearing
- Optional: protection cap
- Recommended by doctors and physiotherapists.

| Item No | EAN*   | Qty |
|---------|--------|-----|
| 60909   | 024699 | 1   |



**Knee pads Fento 400**

- Knees and shins are completely protected
- Perfect fit
- Elasticated straps won't cut into the knee
- Prevents back and knee problems
- Comfortable and sturdy
- Light weight: 370 grams
- Flexible and 100 % waterproof
- Durable and hard-wearing
- Optional: protection cap
- Recommended by doctors and physiotherapists.

| Item No | EAN*   | Qty |
|---------|--------|-----|
| 60910   | 024729 | 1   |



**Spiked soles**

Solvent-resistant plastic, threaded in steel spikes, for walking on fresh coatings without a trace, complete with straps (one set each buckled or hook and loop strap). Standard version.

| Item No | EAN*   | Qty |
|---------|--------|-----|
| 4911    | 549109 | 1   |



Please note: image scale of products may vary.

| <b>Spiked soles, professional</b>   |        |  |     |
|---|--------|--|-----|
| Solvent-resistant plastic, threaded in steel spikes, for walking on fresh coatings without a trace, complete with straps. |        |  |     |
| Item No   | EAN*   |  | Qty |
| 4910  | 549123 |  | 1   |
| <b>Spare spikes (no illustration)</b>   |        |  |     |
| Thread-in, for one pair of soles.<br>1 set = 22 pieces.   |        |  |     |
| 4910E   | 549017 |  | 1   |
| <b>Spare straps (no illustration)</b>   |        |  |     |
| For one pair of soles.<br>1 set = 2 long and 2 short straps.  |        |  |     |
| 4910R   | 549024 |  | 1   |
| <b>Spiked soles (no illustration)</b>   |        |  |     |
| As Item No 4910, but with hook and loop straps.   |        |  |     |
| 4910K   | 500179 |  | 1   |
| <b>Spare hook and loop strap (no illus.)</b>  |        |  |     |
| 1 set = 2 long and 2 short straps.  |        |  |     |
| 4910K/R   | 500216 |  | 1   |



# 100% precise straightedges

| <b>Straightedge, stainless</b>  |        |            |     |
|---|--------|------------|-----|
| Hardened, fine polished stainless strip-steel, 80 mm width, 0.5 mm thickness. |        |            |     |
| Item No   | EAN*   | Dimensions | Qty |
| 80R/205   | 108191 | 2050 mm    | 3   |
| 80R/405   | 108214 | 4050 mm    | 3   |



Made in Germany  
Made by Pajarito



| <b>Straightedge, bowed (no illustration)</b>                                  |        |            |     |
|---|--------|------------|-----|
| Bowed strip-steel straightedge, 80 mm width, 0.5 mm thick, hole for t-square. |        |            |     |
| Item No   | EAN*   | Dimensions | Qty |
| 214B/L/210  | 121473 | 2100 mm    | 3   |
| 214B/L/410  | 121497 | 4100 mm    | 3   |
| 214B/L/510  | 121503 | 5100 mm    | 3   |



Made in Germany  
Made by Pajarito

| <b>Straightedge, bowed, stainless</b> |        |            |     |
|---------------------------------------|--------|------------|-----|
| As Item No 214B/L, but stainless.     |        |            |     |
| Item No                               | EAN*   | Dimensions | Qty |
| 214B/R/L/210                          | 121565 | 2100 mm    | 3   |
| 214B/R/L/410                          | 121589 | 4100 mm    | 3   |
| 214B/R/L/510                          | 121596 | 5100 mm    | 3   |

| <b>T-square</b>                    |        |            |     |
|------------------------------------|--------|------------|-----|
| Zinc-plated t-square, 40 mm width. |        |            |     |
| Item No                            | EAN*   | Dimensions | Qty |
| 214B/R/A                           | 121558 | 600 mm     | 1   |

Queranschlag:  
Art.-Nr. 214B/R/A

Lineal:  
Art.-Nr. 214B/R/L210





III Made in Germany  
Made by Pajarito

| Steel straightedge                           |        |         |     |
|--|--------|---------|-----|
| Polished, chamfered, 40 mm wide, 5 mm thick. |        |         |     |
| Item No                                      | EAN*   | Length  | Qty |
| 212/50                                       | 521228 | 500 mm  | 1   |
| 212/100                                      | 521259 | 1000 mm | 1   |
| 212/150                                      | 521273 | 1500 mm | 1   |
| 212/200                                      | 521297 | 2000 mm | 1   |

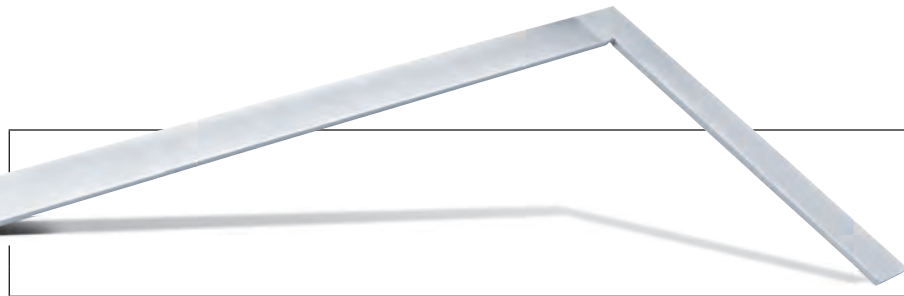

| Steel square                      |        |               |     |
|-----------------------------------|--------|---------------|-----|
| Polished, 30 mm wide, 5 mm thick. |        |               |     |
| Item No                           | EAN*   | Dimensions    | Qty |
| 213/50                            | 521334 | 500 x 280 mm  | 1   |
| 213/100                           | 521365 | 1000 x 500 mm | 1   |



EDELSTAHL Rostfrei III Made in Germany  
Made by Pajarito

| Threshold straightedge, stainless   |        |               |     |
|---|--------|---------------|-----|
| Hardened, polished, bowed, 80 mm wide, 0.5 mm thick, stainless steel blades, infinitely adjustable, from 600 to 1200 mm, wooden grip. |        |               |     |
| Item No   | EAN*   | Dimensions    | Qty |
| 774R  | 177418 | 600 - 1200 mm | 1   |

| Threshold straightedge (no illus.) |        |               |   |
|------------------------------------|--------|---------------|---|
| As Item No 774R, not stainless.    |        |               |   |
| 774                                | 177401 | 600 - 1200 mm | 1 |

5



EDELSTAHL Rostfrei III Made in Germany  
Made by Pajarito

| Threshold straightedge, stainless  |        |               |     |
|--|--------|---------------|-----|
| Stainless steel blade, 0.7 mm thick, 130 mm width, adjustable from 600 mm - 1300 mm. |        |               |     |
| Item No  | EAN*   | Dimensions    | Qty |
| 774B/R   | 177432 | 600 - 1300 mm | 1   |



EDELSTAHL Rostfrei III Made in Germany  
Made by Pajarito

| Threshold straightedge, short, stainless   |        |              |     |
|--|--------|--------------|-----|
| As Item No 774R, but for smaller doors. Hardened, polished, bowed, 80 mm wide, 0.5 mm thick, stainless steel blades, infinitely adjustable, from 460 to 730 mm, wooden grip. |        |              |     |
| Item No  | EAN*   | Dimensions   | Qty |
| 774R/K   | 177456 | 460 - 730 mm | 1   |



EDELSTAHL Rostfrei III Made in Germany  
Made by Pajarito

| Head seam straightedge, stainless  |        |            |     |
|--|--------|------------|-----|
| Trapezoid, stainless steel, 1 mm thick, 95 mm width, 600 mm (bottom) and 420 mm (top) long with 10 mm guide edge. For a trouble-free seam cut, particularly in doorways. |        |            |     |
| Item No  | EAN*   | Dimensions | Qty |
| 766R   | 107668 | 600 mm     | 6   |

Please note: image scale of products may vary.

**Tool bag, empty**

Best genuine cowhide, 430 x 340 x 180 mm, with nickel-plated hardware and adjustable loops. Extremely robust construction with lockable front hasps.

| Item No | EAN*   | Dimensions         | Qty |
|---------|--------|--------------------|-----|
| 942L    | 594215 | 430 x 340 x 180 mm | 1   |



**Feeler gauge**

Particularly suited for covering spiral staircase steps, with angled stop-plate, knurled nut, 3 x 2 feelers of hardened, polished stainless strip steel.



Made in Germany  
Made by Pajarito

| Item No                                | EAN*   | Length  | Qty |
|--|--------|---------|-----|
| 400                                    | 104001 |         | 1   |
| <b>Spare feelers (no illustration)</b> |        |         |     |
| 400EA                                  | 104100 | 600 mm  | 1   |
| 400EB                                  | 104209 | 800 mm  | 1   |
| 400EC                                  | 104308 | 1000 mm | 1   |



**Profile gauge**

PAJARITO profile gauge  
Efficient and accurate measurement of stair edge profiles. Packed in a sturdy wooden box. Measuring range from 740 to 1300 mm.

Made in Germany  
Made by Pajarito

| Item No | EAN*   | Dimensions | Qty |
|---------|--------|------------|-----|
| 776     | 177609 |            | 1   |



**Floor scraper**

Laquered 1400 mm tubular steel handle, welded-on spine, 300 mm wide, for steel blade insertion. Blade not included. Scraper blades see Item No 850E.

| Item No | EAN*   | Total length | Qty |
|---------|--------|--------------|-----|
| 850A    | 185055 | 1400 mm      | 1   |

**Scraper blade**  
Hardened, polished spring band steel, 0.8 mm thick, 115 mm height.

|      |        |        |   |
|------|--------|--------|---|
| 850E | 185017 | 300 mm | 1 |
|------|--------|--------|---|



Made in Germany  
Made by Pajarito

**Push scraper**

Laquered 1400 mm tubular steel handle, welded-on spine, 150 mm wide, for steel blade insertion. Blade not included. Scraper blades see Item No 846E.

| Item No | EAN*   | Total length | Qty |
|---------|--------|--------------|-----|
| 846A    | 184638 | 1400 mm      | 1   |

**Push scraper blade**  
Beveled steel blade, 2.0 mm thick, 150 mm height.

|      |        |        |   |
|------|--------|--------|---|
| 846E | 184621 | 150 mm | 1 |
|------|--------|--------|---|

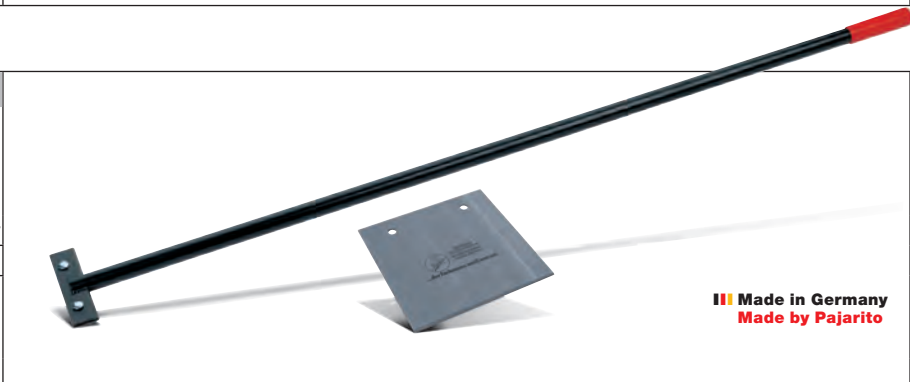

Made in Germany  
Made by Pajarito



III Made in Germany  
Made by Pajarito



**Seam clamps**

Zinc-plated spring wire, with two clamping jaws.

| Item No | EAN*   | Qty |
|---------|--------|-----|
| 937     | 109372 | 2   |

**Carpet stretcher shaft**

Cast light-alloy, adjustable length, pin plate with adjustable pin penetration, plastic-covered bumper pad.

| Item No | EAN*   | Dimensions | Qty |
|---------|--------|------------|-----|
| 936     | 493600 | 450 mm     | 1   |

# Safe cutting

III Made in Germany  
Made by Pajarito



**Carpet cutter Tapicut**

Nickel-plated steel, plastic handle. For cutting and creating seams in cushion backed floor covering. Includes 1 blade Item No 5700SP.

| Item No | EAN*   | Qty |
|---------|--------|-----|
| 669     | 166900 | 1   |

**Spare blades (no illustration)**

For carpet cutter Tapicut (Item No 669), cryogenically hardened, polished steel, 0.3 mm thick. Individually wrapped in waxed paper, 12 pieces in cellophane-wrapped box.

|               |        |    |
|---------------|--------|----|
| <b>5700SP</b> | 557210 | 10 |
|---------------|--------|----|

**Strip cutter attachment**

Attachment for carpet cutter Tapicut (Item No 669). Fixed measuring stop allows 5 different strip width, to be used for skirtings or bonded to skirting boards.

|             |        |   |
|-------------|--------|---|
| <b>669S</b> | 166917 | 1 |
|-------------|--------|---|

5

III Made in Germany  
Made by Pajarito



**Carpet cutter**

Nickel-plated steel, plastic handle. For cutting of carpets with hessian backing (not compact foam). Includes one installed blade and 10 spare blades (Item No 665E).

| Item No | EAN*   | Qty |
|---------|--------|-----|
| 668     | 166801 | 1   |

**Carpet cutter (no illustration)**

As Item No 668, but with up-sloping foot, for cutting velour with hessian backing, i.e. woven velour.

|             |        |   |
|-------------|--------|---|
| <b>668A</b> | 166818 | 1 |
|-------------|--------|---|

Please note: image scale of products may vary.

**Carpet cutter**

Nickel-plated steel, plastic handle. For cutting of carpets with foam backing. Includes one installed blade and 10 spare blades (Item No 768E).

III Made in Germany  
Made by Pajarito



| Item No | EAN*   | Qty |
|---------|--------|-----|
| 768     | 107682 | 1   |

**Spare blades (no illustration)**

Hardened, polished steel, 0.3 mm thick, snap-off, in packs of 10, individually wrapped.

|      |        |     |
|------|--------|-----|
| 768E | 507680 | 100 |
|------|--------|-----|

**Universal cutter, blue**

To be used with foam backed textile flooring, cuts from underside up. Double-cut with short pile carpet. Includes 10 blades Item No 61435E.

| Item No | EAN*   | Qty |
|---------|--------|-----|
| 61435   | 506973 | 1   |

**Spare blades (no illustration)**

In packs of 10.

|        |        |     |
|--------|--------|-----|
| 61435E | 750826 | 100 |
|--------|--------|-----|



**Universal cutter, red**

To be used with non foam backed textile flooring, cuts from top down. Includes 10 blades Item No 665E.

| Item No | EAN*   | Qty |
|---------|--------|-----|
| 61440   | 504726 | 1   |

**Spare blades (no illustration)**

In packs of 10.

|      |        |     |
|------|--------|-----|
| 665E | 566519 | 100 |
|------|--------|-----|



**Edge trimmer**

Nickel-plated steel, wooden handle. For accurate edge trimming of any floor covering (except hard covering) with 2 mounted infinitely adjustable double edged blades (Item No 57D). The cutting angle can also be infinitely adjusted to any material thickness. Accept any popular trapezoid or hooked blades.

III Made in Germany  
Made by Pajarito



| Item No | EAN*   | Qty |
|---------|--------|-----|
| 888     | 108887 | 1   |

**Seam cutter**

Plastic, to cut seams in felt-plastic, needle-felt, etc., as well as trimming of edges. Cutting depth up to 10 mm, with 2 mounted blades and 10 spare blades (Item No 665E).

III Made in Germany  
Made by Pajarito



| Item No | EAN*   | Qty |
|---------|--------|-----|
| 665B    | 566502 | 1   |

5



**Strip cutter**

Infinitely adjustable guide for 40 - 100 mm  
Includes 10 spare blades Item No 767E.

| Item No | EAN*   | Dimensions  | Qty |
|---------|--------|-------------|-----|
| 767     | 507673 | 40 - 100 mm | 1   |

**Spare blades**

Cryogenically hardened steel, 0.4 mm thick, in packs of 10, individually wrapped.

|      |        |  |     |
|------|--------|--|-----|
| 767E | 576709 |  | 100 |
|------|--------|--|-----|

# Cutting & scribing



Made in Germany  
Made by Pajarito

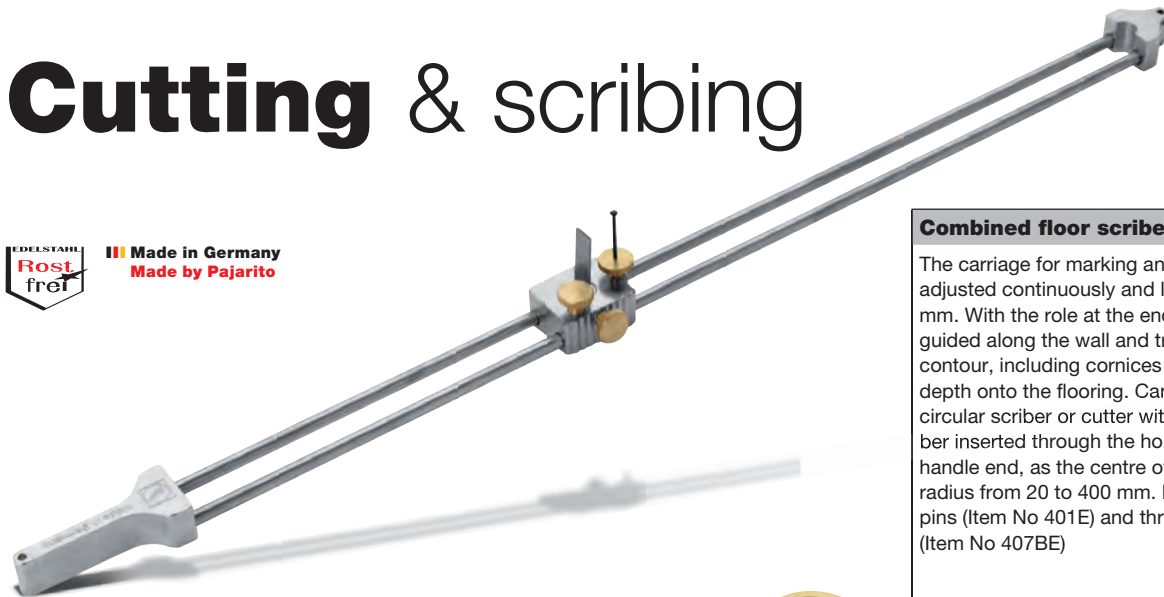

**Combined floor scriber and top cutter**

The carriage for marking and cutting can be adjusted continuously and locked within 385 mm. With the role at the end, the scriber tool is guided along the wall and transmits its contour, including cornices up to 410 mm depth onto the flooring. Can even be used as a circular scriber or cutter with an additional scriber inserted through the hole located at the handle end, as the centre of the circle for any radius from 20 to 400 mm. Includes 10 scriber pins (Item No 401E) and three pointed blades (Item No 407BE)

| Item No | EAN*   | Adjustable area | Qty |
|---------|--------|-----------------|-----|
| 407B    | 104070 | 385 mm          | 10  |
| 407BK   | 114079 | 300 mm          | 10  |

5

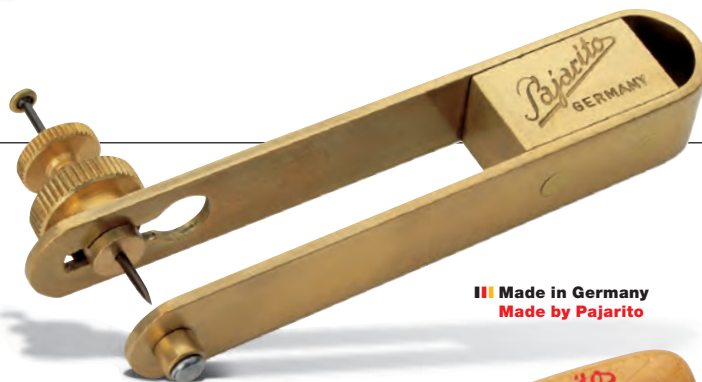

Made in Germany  
Made by Pajarito

**Scribing tool for hard flooring**

Brass, horizontally and vertically adjustable, exchangeable scriber pin. For scribing of covering on steps with nosings. Maximum working range 56 mm, materials up to 8 mm, total length 100 mm. (For scriber pins see Item No 401E).

| Item No | EAN*   | Dimensions | Qty |
|---------|--------|------------|-----|
| 401     | 104018 |            | 12  |



Made in Germany  
Made by Pajarito

**Scribing tool for hard flooring**

As Item No 401, but with 3-way attachable wooden handle, 105 mm long. The handle can be attached horizontally or vertically. Total length including horizontally attached handle: 225 mm. (For scriber pins see Item No 401E).

| Item No | EAN*   | Dimensions | Qty |
|---------|--------|------------|-----|
| 401,1/2 | 104117 |            | 3   |

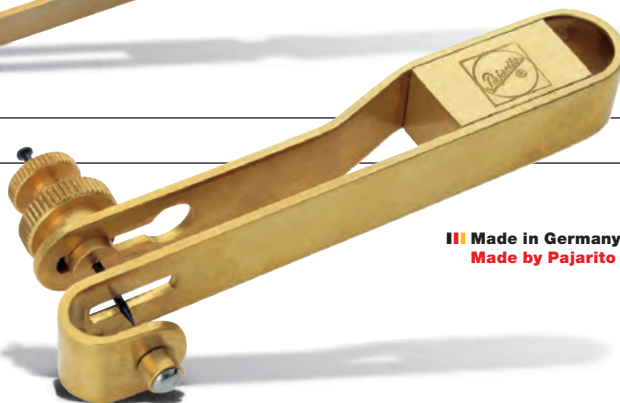

Made in Germany  
Made by Pajarito

**Reverse scriber for hard flooring**

As Item No 401, but with curved guide, total length 110 mm. (For scriber pins see Item No 401E).

| Item No | EAN*   | Dimensions | Qty |
|---------|--------|------------|-----|
| 403     | 104032 |            | 12  |

Please note: image scale of products may vary.

**Combined floor covering scriber and top cutter**

Plastic body, nickel-plated metal parts, light-weight and handy version, for scribing and cutting any hard coverings. By turning the lower guide rail the scriber can also be used as a reverse scriber. Includes 10 scriber pins Item No 401E and 3 pointed blades Item No 407BE.

| Item No | EAN*   | Qty |
|---------|--------|-----|
| 421     | 104216 | 10  |



III Made in Germany  
Made by Pajarito

**Combination floor scriber and top cutter**

A combination of Item No 401, Item No 407B and Item No 403. Scribing and cutting range is 165 or 180 mm. By re-coupling the tool changes to a wall scriber, ideally with the slotted plate facing upward. Includes 10 scriber pins Item No 401E and 3 pointed blades Item No 407BE.

| Item No | EAN*   | Qty |
|---------|--------|-----|
| 404     | 104049 | 10  |

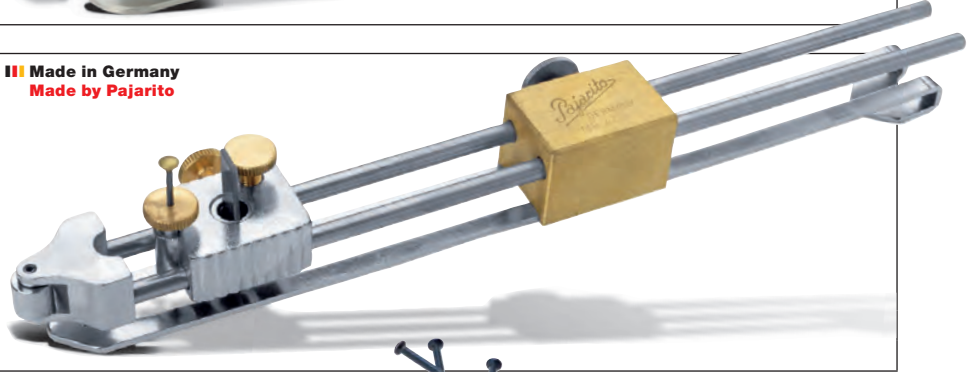

III Made in Germany  
Made by Pajarito

**Scriber pins**

45 mm length, in bags of 25 pieces.

| Item No | EAN*   | Qty |
|---------|--------|-----|
| 401E    | 540106 | 100 |

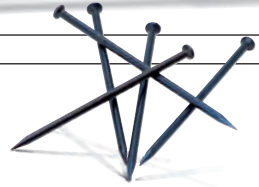

III Made in Germany  
Made by Pajarito

**Pointed blade**

In PVC pockets of 6 pieces.

| Item No | EAN*   | Qty |
|---------|--------|-----|
| 407BE   | 540700 | 6   |



III Made in Germany  
Made by Pajarito

**Hand grooving tool (push or pull)**

Zinc-plated, flat steel blade holder, with blade and wooden handle. Includes 5 spare blades (Item No 662E) in the handle.

| Item No | EAN*   | Qty |
|---------|--------|-----|
| 662     | 166214 | 6   |

**Spare blades**

Hardened, strip steel, beveled on both sides, in bags of 10 pieces.

| Item No | EAN*   | Qty          |    |
|---------|--------|--------------|----|
| 662E    | 166238 | Spare blades | 10 |



III Made in Germany  
Made by Pajarito

**Hand grooving tool**

Zinc-plated bar steel blade holder with J-shaped special blade (Item No 664E) and wooden handle.

| Item No | EAN*   | Qty          |    |
|---------|--------|--------------|----|
| 662A    | 166221 | 6            |    |
| 664E    | 166412 | Spare blades | 10 |



III Made in Germany  
Made by Pajarito

**Hand grooving tool**

As Item No 662A, but with U-shaped special blade (Item No 662BE).

| Item No | EAN*   | Qty |
|---------|--------|-----|
| 662B    | 100621 | 6   |

**Special blade (no illustration)**

U-shaped, hardened strip steel, beveled on both sides, in bags of 10 pieces.

| Item No | EAN*   | Qty          |    |
|---------|--------|--------------|----|
| 662BE   | 100638 | Spare blades | 10 |

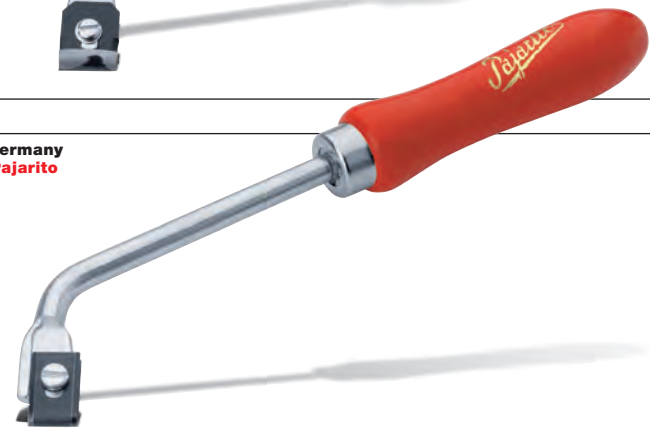

III Made in Germany  
Made by Pajarito



# For the perfect groove



**III Made in Germany**  
**Made by Pajarito**

**Special groover with seam guide**  
 Zinc-plated, flat steel blade holder, with exchangeable J-shaped blade and fine-wood handle. Includes 3 spare blades (Item No 664E) in the handle.

| Item No    | EAN*   | Qty |
|------------|--------|-----|
| <b>664</b> | 166405 | 6   |

**Spare blade (no illustration)**  
 J-shaped, hardened strip steel, beveled on both sides, in bags of 10 pieces.

|             |        |    |
|-------------|--------|----|
| <b>664E</b> | 166412 | 10 |
|-------------|--------|----|



**III Made in Germany**  
**Made by Pajarito**

**Hand grooving tool**  
 Steel, wooden handle, exchangeable blade (Item No 660E) and adjustable seam guide. Hex-key included.

| Item No    | EAN*   | Qty |
|------------|--------|-----|
| <b>660</b> | 566007 | 6   |

**Spare blades, (no illustration)**  
 Hardened bar steel with edges.

|             |        |    |
|-------------|--------|----|
| <b>660E</b> | 566014 | 10 |
|-------------|--------|----|



**III Made in Germany**  
**Made by Pajarito**

**Welding rod feed roller**  
 Nickel-plated roller mounting, concave brass wheel, wooden handle, which is drilled to feed the welding-rod through.

Version:                    A                    B                    D  
 Wheel-diam.:            30 mm    20 mm    15 mm  
 Weld.-rod-diam.:      4-5 mm   2-4 mm   2-4 mm

| Item No     | EAN*   | Version | Qty |
|-------------|--------|---------|-----|
| <b>610A</b> | 161011 | A       | 6   |
| <b>610B</b> | 161028 | B       | 6   |
| <b>610D</b> | 161042 | D       | 6   |



**III Made in Germany**  
**Made by Pajarito**

**PVC film roller**  
 As Item No 610A but with convex brass wheel, 30 mm diameter.

| Item No     | EAN*   | Dimensions | Qty |
|-------------|--------|------------|-----|
| <b>610C</b> | 161035 |            | 6   |



**III Made in Germany**  
**Made by Pajarito**

**Hand roller**  
 Zinc-plated metal holder, convex, nickel-plated wheel with ball-bearing, 30 mm diameter, sturdy wooden handle. Especially heavy model, for welding PVC and pressing floor covering near the wall.

| Item No    | EAN*   | Dimensions | Qty |
|------------|--------|------------|-----|
| <b>611</b> | 106111 |            | 6   |

5

Please note: image scale of products may vary.

| Quarter moon, (spatula) knife  |             |   |            |
|--|-------------|---|------------|
| Hardened, polished, sharp, beveled special knife steel blade on both sides, resin-embedded in wooden handle with brass ferrule. Blade length 100 mm, blade width 70 mm, total length 220 mm. |             |  |            |
| <b>Item No</b>   | <b>EAN*</b> |   | <b>Qty</b> |
| 661  | 566106      |   | 6          |

| Quarter moon, (spatula) knife                   |             |  |            |
|---|-------------|--|------------|
| As Item No 661, but with riveted wooden handle. |             |  |            |
| <b>Item No</b>                                  | <b>EAN*</b> |  | <b>Qty</b> |
| 661P  | 566113      |  | 6          |

| Quarter moon, (spatula) knife           |             |  |            |
|---|-------------|--|------------|
| As Item No 661P, but with angled blade. |             |  |            |
| <b>Item No</b>                          | <b>EAN*</b> |  | <b>Qty</b> |
| 661S                                    | 566120      |  | 6          |

| Leather sheath for quarter moon                                    |             |   |            |
|--|-------------|---|------------|
| Top grain leather, sturdily sewn and riveted, press stud closure.. |             |  |            |
| <b>Item No</b>   | <b>EAN*</b> |   | <b>Qty</b> |
| 661T   | 566137      |   | 10         |

| Welding seam guide                        |             |   |            |
|---|-------------|---|------------|
| Steel plate, fits any quarter moon knife. |             |  |            |
| <b>Item No</b>                            | <b>EAN*</b> |   | <b>Qty</b> |
| 661V                                      | 566144      |   | 6          |

| Trimming knife  |             |  |            |
|---|-------------|--|------------|
| <p>Patent solution for safe, clean, quick trimming of welded seams.</p> <p><b>Convenient</b> ...because the pre-cut slide is integrated in the tool,<br/>...because a blunt blade is simply replaced, no re-grinding.</p> <p><b>Safe</b> ...because the blade glides over the surface absolutely smoothly, preventing scratches and nicks,<br/>...because the cutting edge is in the centre and cannot cause injury,<br/>...because the handle was designed for single-handed use, which ensures stress-free working.</p> <p><b>Fast</b> ...because there is no need for re-working or repairing.</p> |             |  |            |
| <b>Item No</b>  | <b>EAN*</b> |  | <b>Qty</b> |
| 62900   | 019039      |  | 6          |
| Spare blades  |             |  |            |
| <b>Item No</b>  | <b>EAN*</b> |  | <b>Qty</b> |
| 62901   | 019046      |  | 12         |
| Replacement slide   |             |  |            |
| <b>Item No</b>  | <b>EAN*</b> |  | <b>Qty</b> |
| 62902   | 019053      | 0,5 mm   | 10         |
| 62903   | 022008      | 0,7 mm   | 10         |

1



Der Vorschritt mit eingeschwenktem Schlitten

2



Der Nachschritt mit ausgeschwenktem Schlitten

3



Das perfekte Ergebnis

| Planing knife  |             |  |            |
|--|-------------|--|------------|
| Steel blade, 5 cm, rounded corners, ground-in notch for planing PVC welding rods, gently curved wooden handle. |             |  |            |
| <b>Item No</b>   | <b>EAN*</b> |  | <b>Qty</b> |
| 659  | 106593      |  | 12         |

| Carborundum file  |             |  |            |
|---|-------------|--|------------|
| For re-sharpening of the planing knife (Item No 659). 100 mm length, 8 mm diameter. |             |  |            |
| <b>Item No</b>  | <b>EAN*</b> |  | <b>Qty</b> |
| 659F  | 506591      |  | 12         |



# Professional kings for

## PAJARITO Strip Cutting King

- + Especially developed for cutting the long sides of large designer panels and tiles, to cut and fit them to walls easily and economically
- + Easily re-configured to a strip cutter
- + Made in Germany – Made by Pajarito



PAJARITO Strip Cutting King

5

### PAJARITO Strip Cutting King

Where commercial punches reach their size limits, the Strip Cutting King helps. Engineered for cutting ever longer plank sizes easily and economically on the wall, it utilises the 'wall hugging technology' to cut the plank to a perfect fit. The flooring can be cut directly on the wall without measuring and marking. The Strip Cutting King can be adjusted quickly and precisely using the precision scale. Parquet and laminate can be marked with the help of the included pen holder for cutting without measuring. It can easily be turned into a strip cutter to quickly and accurately produce skirting strips on site.

| Item No | EAN*   |                  | Qty |
|---------|--------|------------------|-----|
| 440     | 029083 |                  | 1   |
| 570 E/K | 557050 | Trapezoid blades | 10  |



### PAJARITO Twin pressure roll

Pressure roll for flooring work with sealed steel ball-bearings. The slanted, bowed handle supports a natural hand-positioning.

| Item No | EAN*   |  | Qty |
|---------|--------|--|-----|
| 442     | 029090 |  | 1   |

# design flooring

**PAJARITO Twin pressure roller**  
+ Ergonomically shaped

**PAJARITO Chamfer King**  
+ Precision trimming of edges  
+ Small and handy  
+ Chamfering or planing without re-assembly  
+ Made in Germany – Made by Pajarito



PAJARITO Twin pressure roller



PAJARITO Chamfer-King

## PAJARITO Chamfer King

The new Pajarito Chamfer King was designed for professional design installations. Especially with modern design flooring, it often happens that the lower edge of an element must be chamfered or planed in the tenths. This very dynamic tool has been created from experience. The integrated industrial blade cuts effortlessly and perfectly clean due to the small thickness and extraordinary sharpness, even through rigid flooring. The stops are designed without the need for a complicated change procedure. Chamfering or shortening the design flooring is done without re-assembly. Blade change and adjustment take less than a minute.

| Item No | EAN*   |              | Qty |
|---------|--------|--------------|-----|
| 443     | 029106 |              | 1   |
| 443 E   | 029236 | Spare blades | 10  |



III Made in Germany  
Made by Pajarito



**Seam roller**

Barrel shaped steel roller, 45 mm width, 30 mm diameter, wooden handle.

| Item No | EAN*   |  | Qty |
|---------|--------|--|-----|
| 752     | 107521 |  | 6   |

III Made in Germany  
Made by Pajarito



**Carpet seam roller**

Nickel/plated frame, 13 nickel/plated star wheels, steel axle, wooden handle.

| Item No | EAN*   | Width | Qty |
|---------|--------|-------|-----|
| 408     | 104087 | 85 mm | 1   |

III Made in Germany  
Made by Pajarito



**Special flooring hammer**

Black lacquered head, 500 g, 90 mm wide fin, polished ashwood handle.

| Item No | EAN*   |  | Qty |
|---------|--------|--|-----|
| 405     | 540502 |  | 1   |

III Made in Germany  
Made by Pajarito



**Linoleum flooring roller, 30 kg**

Four zinc-plated rollers, 85 mm diameter, 515 mm total width, integrated transport castors, detachable steel tube crossbar-handle, 115 cm long.

| Item No | EAN*   |  | Qty |
|---------|--------|--|-----|
| 116B/N  | 016601 |  | 1   |

III Made in Germany  
Made by Pajarito



**Linoleum flooring roller, 55 kg**

Four zinc-plated rollers, 125 mm diameter, 515 mm total width, integrated transport castors, detachable steel tube crossbar-handle, 115 cm long.

| Item No | EAN*   |  | Qty |
|---------|--------|--|-----|
| 116A/N  | 016595 |  | 1   |



All linoleum flooring rollers have integrated transport castors.

III Made in Germany  
Made by Pajarito



**Linoleum flooring roller, 70 kg**

Four zinc-plated rollers, 145 mm diameter, 515 mm total width, integrated transport castors, detachable steel tube crossbar-handle, 115 cm long.

| Item No | EAN*   |  | Qty |
|---------|--------|--|-----|
| 116D/N  | 017073 |  | 1   |

Please note: image scale of products may vary.

5

**Pajarito pressure roller, arched**

The arched steel tube handle and the additional grip-handle allow for greater pressure on the flooring.

Specifications:

Three steel rollers covered with hard rubber, 47 mm diameter, arched steel tube handle, 120 cm long, with additional wooden grip-handle.  
Weight: approx. 6 kg

| Item No | EAN*   | Width  | Qty |
|---------|--------|--------|-----|
| 116G    | 018889 | 320 mm | 1   |



Made in Germany  
Made by Pajarito



Practical handle for additional pressure!

**Pressure roller, 4.5 kg**

Three steel rollers covered with hard rubber, 47 mm diameter, steel tube handle, 120 cm long.

| Item No | EAN*   | Width  | Qty |
|---------|--------|--------|-----|
| 116E    | 101208 | 320 mm | 1   |



Made in Germany  
Made by Pajarito

**Carpet glider, 5.0 kg**

Detachable, square tube, 5 x 5 cm, with polished, rounded edges, steel tube handle, 145 cm long.

| Item No | EAN*   | Width  | Qty |
|---------|--------|--------|-----|
| 116F    | 101215 | 500 mm | 1   |



Made in Germany  
Made by Pajarito

**Carpet glider, 1.8 kg**

Large beechwood block, 77 x 44 mm, with rounded long edges, detachable wooden handle, 150 cm long.

| Item No | EAN*   | Width  | Qty |
|---------|--------|--------|-----|
| 11600   | 116004 | 400 mm | 1   |



Made in Germany  
Made by Pajarito

**Carpet clamp, premium**

Steel, spring mounted clamping jaw, pivoting wooden handle.

| Item No | EAN*   | Qty |
|---------|--------|-----|
| 877     | 108771 | 1   |

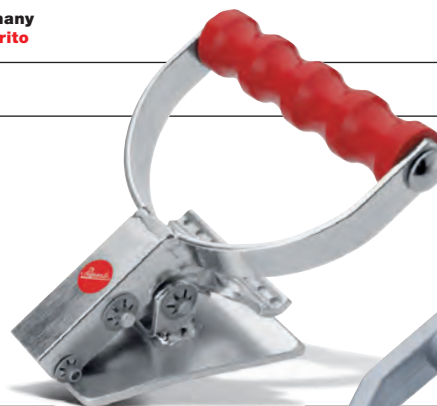

Made in Germany  
Made by Pajarito

**Carpet clamp**

Sturdy, all metal.

| Item No | EAN*   | Qty |
|---------|--------|-----|
| 879     | 501879 | 1   |



5

# Parquet perfectly laid

III Made in Germany  
Made by Pajarito



Art.-Nr. 782A

Art.-Nr. 782B

### Parquet pull bars

Solid, zinc-plated steel, strike head equipped with impact-cushioning nylon cover.

| Item No     | EAN*   | Dimensions | Qty |
|-------------|--------|------------|-----|
| <b>782A</b> | 278214 | 430 mm     | 1   |
| <b>782B</b> | 278221 | 550 mm     | 1   |



### Joiner's try squares

Brass mounts, miter and scale, 250 mm leg length.

| Item No    | EAN*   | Qty |
|------------|--------|-----|
| <b>735</b> | 504542 | 6   |



### Joiner's adjustable bevel

Natural wooden handle with brass mounts, leg length 250 mm.

| Item No    | EAN*   | Qty |
|------------|--------|-----|
| <b>734</b> | 504788 | 6   |

5



### Carpenter's pencils

Oval shape, set of 3 in plastic pouch.

| Item No     | EAN*   | Qty |
|-------------|--------|-----|
| <b>8913</b> | 709121 | 12  |

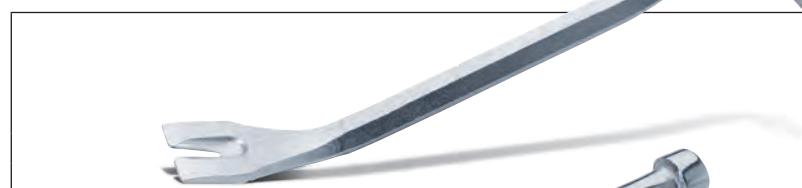

### Moulding lifter (gooseneck)

Zinc-plated, forged, hexagonal steel.

| Item No    | EAN*   | Dimensions | Qty |
|------------|--------|------------|-----|
| <b>920</b> | 509202 | 270 mm     | 6   |



### Stair tool

Forged, finely polished, chrome-plated.

| Item No       | EAN*   | Dimensions | Qty |
|---------------|--------|------------|-----|
| <b>781/70</b> | 107811 | 70 mm      | 3   |



### Hole punch

Forged, hardened, lacquered steel, beveled cutting edge.

| Item No       | EAN*   | Hole diameter | Qty |
|---------------|--------|---------------|-----|
| <b>938/20</b> | 593829 | 20 mm         | 1   |
| <b>938/40</b> | 593843 | 40 mm         | 1   |

Please note: image scale of products may vary.

**Divider with locking arch**

Forged, polished steel, one tip slightly curved.

| Item No | EAN*   | Dimensions | Qty |
|---------|--------|------------|-----|
| 81      | 500810 | 150 mm     | 1   |

**Carpet awl**

Nickel-plated blade, 100 mm long, plastic handle.

| Item No | EAN*   | Dimensions | Qty |
|---------|--------|------------|-----|
| 921     | 509219 |            | 12  |

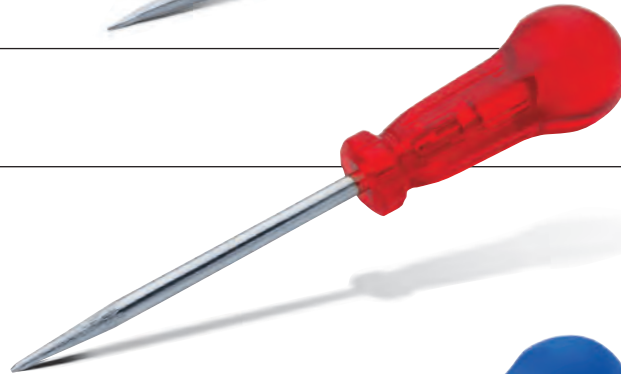
**Square awl**

Nickel-plated blade, 100 mm long, plastic handle.

| Item No | EAN*   | Dimensions | Qty |
|---------|--------|------------|-----|
| 922     | 509226 |            | 12  |

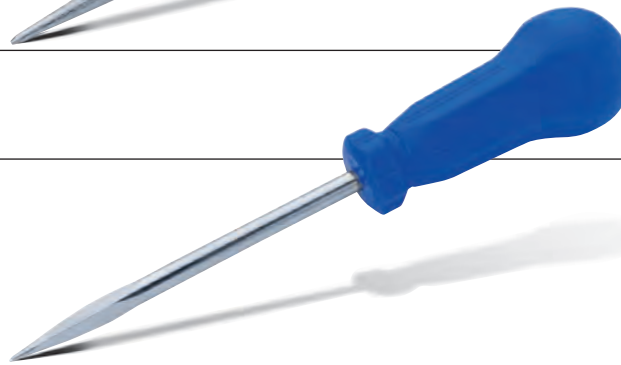

## We especially like ...

... searching for new ideas.

**Listening is also a speciality of ours. And once we know what you want, the tool you need is born. Perfectly suited to your requirements.**

**Pajarito: Full of ideas. Exceptionally so; since 1923.**



5



| Glue syringe   |        |            |     |
|--|--------|------------|-----|
| Plastic, 60 ml capacity, 1 special steel injection needle, protective cover. |        |            |     |
| Item No  | EAN*   | Dimensions | Qty |
| 965  | 596509 | 70 mm      | 10  |



| Carpet pins  |        |            |     |
|--|--------|------------|-----|
| Nickel-plated steel pin, 70 mm long, plastic cap 30 mm diameter. |        |            |     |
| Item No  | EAN*   | Dimensions | Qty |
| 253S   | 525325 | 85 mm      | 50  |



| Carpet ring pins         |        |            |     |
|--------------------------|--------|------------|-----|
| Steel, 1.5 mm thickness. |        |            |     |
| Item No                  | EAN*   | Dimensions | Qty |
| 253/75                   | 525318 | 75 mm      | 100 |

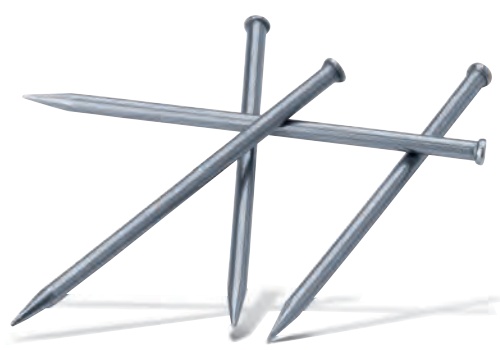

| Steel nails   |        |            |     |
|---|--------|------------|-----|
| Hardened, bright, 1.5 mm thick, punched point, small flat head, in packets of 1000 pcs. |        |            |     |
| Item No   | EAN*   | Dimensions | Qty |
| 522/20  | 552208 | 20 mm      | 1   |
| 522/25  | 552215 | 25 mm      | 1   |
| 522/30  | 552222 | 30 mm      | 1   |
| 522/35  | 552239 | 35 mm      | 1   |
| 522/45  | 552246 | 45 mm      | 1   |
| Steel nails   |        |            |     |
| As Item No 522, but in a bag of 100 pcs.  |        |            |     |
| 522S/25   | 552253 | 25 mm      | 1   |
| 522S/35   | 552260 | 35 mm      | 1   |



| Pins   |        |            |     |
|--|--------|------------|-----|
| Brad heads, non-hardened, in packets of 100 grams, length x thickness: 25 x 1.4 mm or 30 x 1.6 mm. |        |            |     |
| Item No  | EAN*   | Dimensions | Qty |
| 234/25/100   | 524076 | 25 mm      | 10  |
| 234/30/100   | 524106 | 30 mm      | 10  |

Please note: image scale of products may vary.

# Furniture dolly

## Furniture dolly

Sturdy construction with laminated, 18 mm thick plywood board, four swivel castors. Transport surface: 295 x 600 mm.

| Item No | EAN*   | Load capacity | Qty |
|---------|--------|---------------|-----|
| 50851   | 508519 | 200 kg        | 1   |



# Bucket cart

## Bucket cart

Practical bucket cart for floor filling compound and paint bucket. Suitable for bucket diameter of up to 500 mm with lock-in mechanism. The bucket cart can be easily transported simply by removing the handle.

### Dimensions:

L 500 mm x B 350 mm x H 990 mm

### Weight:

5,1 kg

### Scope of delivery:

Bucket car (without bucket)

| Item No | EAN*   | Load  | Qty |
|---------|--------|-------|-----|
| 795     | 107958 | 100kg | 1   |



# Pack mule

## Hand trucks

Convenient hand truck to transport goods of all kinds, wheel protectors, safety handles. All steel parts with plastic coating. Large pneumatic wheels with lug tread and car valves.

|                   |                 |
|-------------------|-----------------|
| Load capacity:    | 300 kg          |
| Total height:     | 1250 mm         |
| Total width:      | 510 mm          |
| Frame width:      | 285 mm          |
| Nose plate width: | 300 mm          |
| Nose plate depth: | 245 mm          |
| Wheels:           | Pneumatic tyres |
| Wheel diameter:   | 240 mm          |
| Tyre width:       | 80 mm           |
| Rim:              | Plastic rim     |
| Hub bearing:      | Plain bearings  |
| Weight:           | 9 kg            |

| Item No | EAN*   | Load capacity | Qty |
|---------|--------|---------------|-----|
| 792N    | 027447 | 300 kg        | 1   |





50 JAHRE  
**Pajarito**  
**Flevacta**  
 No. 214 B

- Praktische Neuheit zum Schneiden von Boden- und Wandbelägen

Kombination von Kreuzwinkel und Lineal

- Unverrückbares Festhalten auf Fußboden und Wänden durch dachförmigen Querschnitt des Lineals
- Seine Flexibilität (aufrollbar!) gestattet mühelosen Transport

**Pajarito**  
 No 999  
**Aufstreichkelle**  
 mit auswechselbaren Zahnleisten aus besonders abriebfestem Stahl zum Verlegen von KLEINMOSAIK, FLIESEN aus Keramik und Kunststoff

Für alle Kleber und Klebemörtel die richtige Zahnform.

- Grobe Zahnung
- Feine Zahnung
- Spezialzahnung
- Andere Zahnformen auf Anfrage

siehe Rückseite

Er nimmt **Pajarito** WERKZEUGE  
 ...und Sie ?

® zum Anstreichen, Tapezieren und Bodenverlegen

## Good from experience; since 1923

6

**Experience and success, know-how based on tradition and innovation, expertise, continuity, smooth processes, short delivery periods and qualified staff: that is the world of Pajarito.**

The Pajarito success story started in 1923. The fact that we could gather a lot of expertise at that time from our initial activities as an overseas exporter of high-quality consumer merchandise is evidenced even today by our excellent references worldwide. Our many years of experience have likewise shown us that it is not possible to achieve quality without qualified staff. We select our teams carefully and nurture various skill sets. And we attach great

importance to “home grown” young talents. These have been decisive factors for us for sustainable corporate success – for almost 100 years.

**Tools from Pajarito: because quality is also important experience.**

# Health and safety, workshop and construction site requirements

Our highlight product: **PAJARITO Teletower**  
small in transport, big in action

5 adjustable scaffold heights  
for a working height up to 4 m

Minimal footprint  
for easy transport

All round  
safety railing



Best of Pajarito! Up in less than 3 minutes! The telescoping mechanism of the two-part Teletower allows for five quickly and easily adjustable standing heights from 1 meter to 2 meters (working height 3-4 meters). The large working platform made of aluminum is slip resistant, the ascent is through a hatch. Transportable in the station wagon or small van. Maximum load 150 kg. EN1004 compliant.

You can find the **PAJARITO Teletower** from page 158.



Hammers on page 146



Pliers from page 147



Brooms on page 150



Gloves from page 154

# Hammers and **lump hammers**



**Machinist hammer**  
Forged, ground, black laquered head, polished face and peen, wooden handle. TÜV/GS tested.

| Item No        | EAN*   | Weight | Qty |
|----------------|--------|--------|-----|
| <b>250/100</b> | 425007 | 100 g  | 6   |
| <b>250/200</b> | 425014 | 200 g  | 6   |
| <b>250/300</b> | 425021 | 300 g  | 6   |
| <b>250/400</b> | 425038 | 400 g  | 6   |
| <b>250/500</b> | 425045 | 500 g  | 6   |



**Rust removal hammer**  
Forged, ground, black laquered head, wooden handle.

| Item No    | EAN*   | Weight | Qty |
|------------|--------|--------|-----|
| <b>251</b> | 502517 | 500 g  | 2   |



**Lump hammer**  
Forged, ground, black laquered head, polished faces, chamfered edges, wooden handle.

| Item No    | EAN*   | Weight | Qty |
|------------|--------|--------|-----|
| <b>819</b> | 508199 | 1000 g | 2   |



**Rubber mallet**  
With rubber head, wooden handle, total length 290 mm.

| Item No    | EAN*   | Weight | Qty |
|------------|--------|--------|-----|
| <b>419</b> | 504191 | 500 g  | 5   |



**Carpenter's hammer**  
Forged, steel-tube shaft, total length 310 mm. TÜV/GS tested.

| Item No    | EAN*   | Weight | Qty |
|------------|--------|--------|-----|
| <b>255</b> | 506812 | 840 g  | 4   |

6

Please note: image scale of products may vary.

**Plasterer's hatchet**

Forged, polished blade, steel-tube shaft handle total length 310 mm. TÜV/GS tested.

| Item No | EAN*   | Weight | Qty |
|---------|--------|--------|-----|
| 256     | 506829 | 500 g  | 4   |

**Flat chisel**

Hardened, forged steel, 25 mm width.

| Item No | EAN*   | Length | Qty |
|---------|--------|--------|-----|
| 8821    | 782100 | 200 mm | 6   |

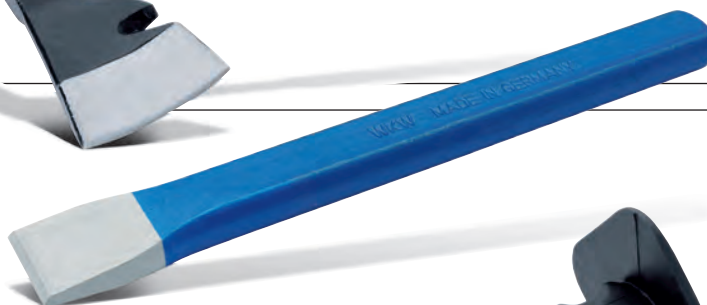
**Flat chisel**

Hardened, forged steel, hand-guard, 30 mm width.

| Item No | EAN*   | Length | Qty |
|---------|--------|--------|-----|
| 8823    | 670322 | 300 mm | 1   |

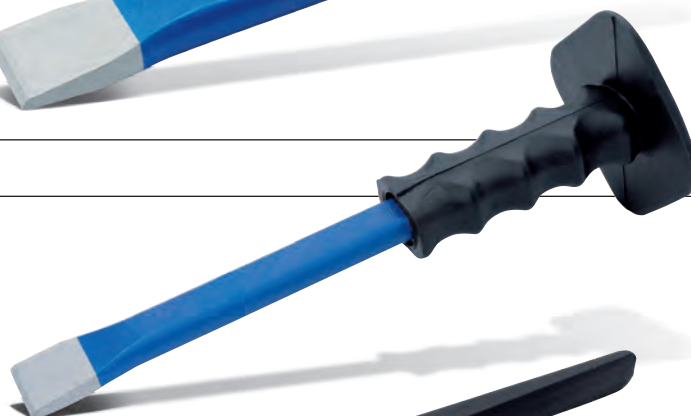
**Knipex pincers**

Special tool steel, oil-hardened, polished head, black atramentised handles, for toughest use, easy action.

| Item No | EAN*   | Length | Qty |
|---------|--------|--------|-----|
| 55621   | 556213 | 180 mm | 6   |

**Pincers**

Black coated, polished head. Standard version.

| Item No | EAN*   | Length | Qty |
|---------|--------|--------|-----|
| 8255    | 425526 | 180 mm | 6   |

**Knipex groove joint pliers**

Chrom-vanadium electrical steel, oil-hardened, polished head, gripping surfaces with especially hardened grooves, slap-joint, seven adjustable size settings, finger jamming protection, cushioned handles.

| Item No | EAN*   | Length | Qty |
|---------|--------|--------|-----|
| 55619   | 556190 | 250 mm | 6   |

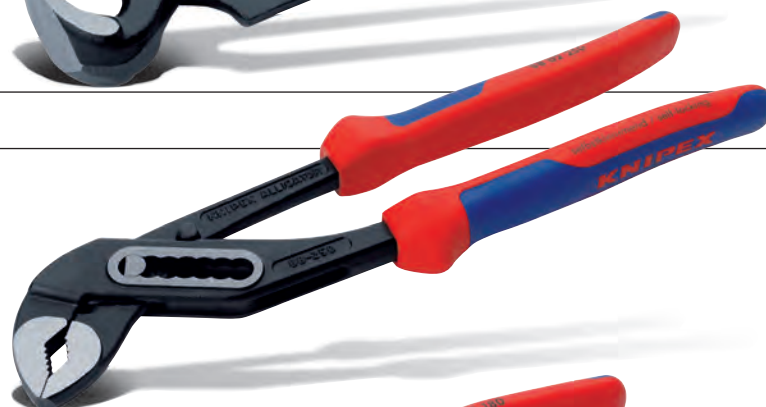
**Knipex combination pliers**

Induction hardened cutters for hard or soft wire, and longer cutters for thicker wire. Special tool steel, oil-hardened, polished head, handles with thick-wanded plastic grips.

| Item No | EAN*   | Length | Qty |
|---------|--------|--------|-----|
| 55618   | 556183 | 180 mm | 6   |



6

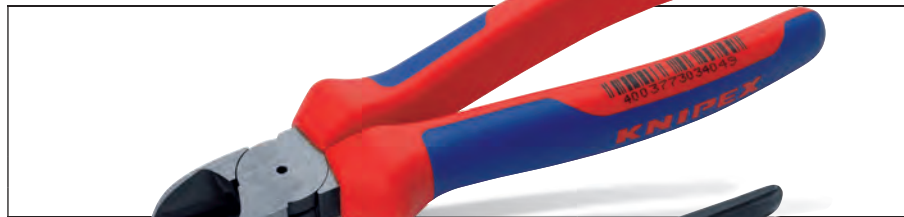

| <b>Knipex diagonal cutting pliers</b>  |        |        |     |
|--|--------|--------|-----|
| Special tool steel, oil-hardened, polished head, handles with thick-wanded plastic grips. Induction hardened cutters for precision cuts. |        |        |     |
| Item No  | EAN*   | Length | Qty |
| 55518  | 555186 | 180 mm | 6   |



| <b>Knipex concreter's nippers</b>   |        |        |     |
|---|--------|--------|-----|
| Special tool steel, oil-hardened, polished head, black atramentised handles, for fast, reliable tying of concrete reinforcing steel , twisting and cutting in one go. |        |        |     |
| Item No   | EAN*   | Length | Qty |
| 55522   | 555223 | 220 mm | 6   |

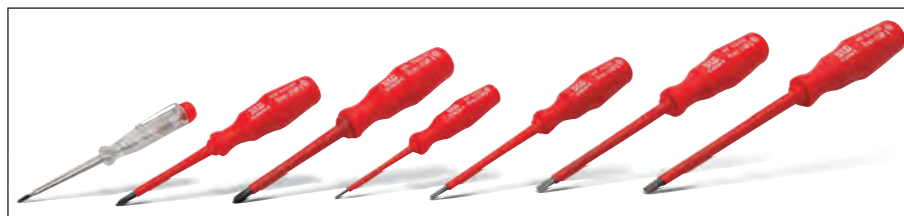

| <b>VDE screwdriver set</b>  |        |  |     |
|---|--------|--|-----|
| Electric set (7-pieces), 4x slotted, 2x Phillips tips, 1x voltage tester, chrome-vanadium-steel, insulated according to VDE, blades with hardened tips. |        |  |     |
| Item No   | EAN*   |  | Qty |
| 10266   | 506843 |  | 1   |



| <b>Professional screwdriver set</b>   |        |  |     |
|---|--------|--|-----|
| Professional set (6-pieces) 4x slotted, 2x Phillips tips, chrome-vanadium-steel, blades with hardened tips. |        |  |     |
| Item No   | EAN*   |  | Qty |
| 10267   | 506850 |  | 1   |



| <b>Voltage tester</b>                           |        |              |     |
|---|--------|--------------|-----|
| Insulated blade and plastic handle, metal clip. |        |              |     |
| Item No   | EAN*   | Total length | Qty |
| 55309   | 553090 | 145 mm       | 12  |

6



| <b>Knipex Twinkey</b>  |        |        |     |
|--|--------|--------|-----|
| <b>Opens almost anything</b>   |        |        |     |
| Multifunction zinc diecast key for actuation of closures. Consisting of two cross keys and a reversible bit held together by space-saving means of magnets and stainless steel wire. |        |        |     |
| Item No  | EAN*   | Weight | Qty |
| 55668  | 027164 | 135 g  | 1   |

Please note: image scale of products may vary.

**Construction site key**

Nickel-plated cast steel, inner and outer squares for doors and windows.

| Item No | EAN*   | Dimensions | Qty |
|---------|--------|------------|-----|
| 8068    | 101284 | 145 mm     | 6   |

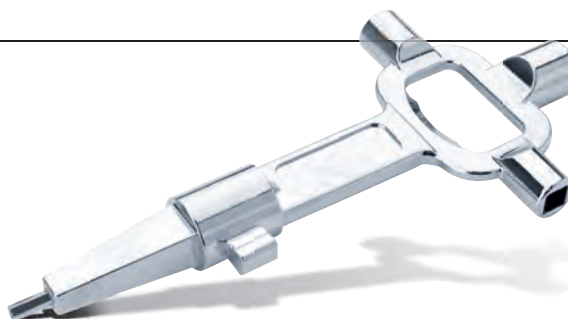

**Barrier tape**

Polyethylene, chloride and sulphur free, extremely tear-resistant, 80 mm wide, colours red and white.

| Item No | EAN*   | Dimensions | Qty |
|---------|--------|------------|-----|
| 51017   | 000853 | 500 m      | 1   |



# Roofmakers

**Carbide-tipped scorer**

Moulded-on, ergonomically shaped plastic handle, steel blade with soldered-in carbide tip, for scoring fibre-concrete board or similar materials.

| Item No | EAN*   | Dimensions | Qty |
|---------|--------|------------|-----|
| 5701    | 557227 | 150 mm     | 10  |



III Made in Germany  
Made by Pajarito

**Seam roller**

Zinc-plated steel roller, 40 mm wide, 40 mm diameter, with ball-bearing, zinc-plated frame, wooden handle.

| Item No | EAN*   | Dimensions | Qty |
|---------|--------|------------|-----|
| 757     | 107576 | 220 mm     | 3   |



III Made in Germany  
Made by Pajarito

**Seam roller**

Nickel-plated frame, silicon roller, 45 mm wide, 30 mm diameter, wooden handle.

| Item No | EAN*   | Dimensions | Qty |
|---------|--------|------------|-----|
| 758     | 107583 | 180 mm     | 6   |



III Made in Germany  
Made by Pajarito

**Roofing felt shearing knife**

Hardened, polished special steel blade, wooden handle, for cutting of roofing felt.









| Item No | EAN*   | Dimensions | Qty |
|---------|--------|------------|-----|
| 759     | 107590 | 230 mm     | 12  |

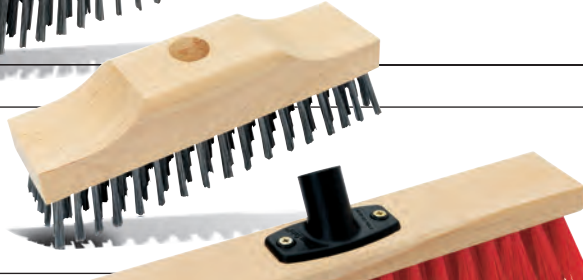

III Made in Germany  
Made by Pajarito



# Brooms and brushes

|     | <p><b>Steel wire broom</b></p> <p>Straight, hardened steel wire in tufts of 70 mm length in 6 rows.</p> <table border="1"> <thead> <tr> <th>Item No</th> <th>EAN*</th> <th>Dimensions</th> <th>Qty</th> </tr> </thead> <tbody> <tr> <td>156/35</td> <td>500025</td> <td>350 x 70 mm</td> <td>1</td> </tr> </tbody> </table>   | Item No     | EAN* | Dimensions | Qty | 156/35 | 500025 | 350 x 70 mm | 1  |       |        |        |    |
|--|---|-------------|------|------------|-----|--------|--------|-------------|----|-------|--------|--------|----|
| Item No  | EAN*  | Dimensions  | Qty  |            |     |        |        |             |    |       |        |        |    |
| 156/35   | 500025  | 350 x 70 mm | 1    |            |     |        |        |             |    |       |        |        |    |
|     | <p><b>Steel wire scrub brush</b></p> <p>Straight, hardened steel wire in tufts of 35 mm length in 6 rows.</p> <table border="1"> <thead> <tr> <th>Item No</th> <th>EAN*</th> <th>Dimensions</th> <th>Qty</th> </tr> </thead> <tbody> <tr> <td>157</td> <td>501572</td> <td>220 x 60 mm</td> <td>2</td> </tr> </tbody> </table>  | Item No     | EAN* | Dimensions | Qty | 157    | 501572 | 220 x 60 mm | 2  |       |        |        |    |
| Item No  | EAN*  | Dimensions  | Qty  |            |     |        |        |             |    |       |        |        |    |
| 157  | 501572  | 220 x 60 mm | 2    |            |     |        |        |             |    |       |        |        |    |
|     | <p><b>Coarse broom</b></p> <p>Straight, red Elaston-bridles in 6 rows, flat wood, tapered plastic socket.</p> <table border="1"> <thead> <tr> <th>Item No</th> <th>EAN*</th> <th>Width</th> <th>Qty</th> </tr> </thead> <tbody> <tr> <td>51016</td> <td>000860</td> <td>400 mm</td> <td>10</td> </tr> <tr> <td>51022</td> <td>003687</td> <td>600 mm</td> <td>10</td> </tr> </tbody> </table>     | Item No     | EAN* | Width      | Qty | 51016  | 000860 | 400 mm      | 10 | 51022 | 003687 | 600 mm | 10 |
| Item No  | EAN*  | Width       | Qty  |            |     |        |        |             |    |       |        |        |    |
| 51016  | 000860  | 400 mm      | 10   |            |     |        |        |             |    |       |        |        |    |
| 51022  | 003687  | 600 mm      | 10   |            |     |        |        |             |    |       |        |        |    |
|    | <p><b>Industrial floor broom</b></p> <p>Real horse hair, natural wooden block, tapered plastic socket.</p> <table border="1"> <thead> <tr> <th>Item No</th> <th>EAN*</th> <th>Width</th> <th>Qty</th> </tr> </thead> <tbody> <tr> <td>51009</td> <td>510093</td> <td>400 mm</td> <td>10</td> </tr> <tr> <td>51033</td> <td>510338</td> <td>600 mm</td> <td>10</td> </tr> </tbody> </table>        | Item No     | EAN* | Width      | Qty | 51009  | 510093 | 400 mm      | 10 | 51033 | 510338 | 600 mm | 10 |
| Item No  | EAN*  | Width       | Qty  |            |     |        |        |             |    |       |        |        |    |
| 51009  | 510093  | 400 mm      | 10   |            |     |        |        |             |    |       |        |        |    |
| 51033  | 510338  | 600 mm      | 10   |            |     |        |        |             |    |       |        |        |    |
|  | <p><b>Industrial floor broom</b></p> <p>Robust coco fibre fill, natural wooden block, tapered plastic socket.</p> <table border="1"> <thead> <tr> <th>Item No</th> <th>EAN*</th> <th>Width</th> <th>Qty</th> </tr> </thead> <tbody> <tr> <td>51010</td> <td>510109</td> <td>400 mm</td> <td>10</td> </tr> <tr> <td>51011</td> <td>510116</td> <td>600 mm</td> <td>10</td> </tr> </tbody> </table> | Item No     | EAN* | Width      | Qty | 51010  | 510109 | 400 mm      | 10 | 51011 | 510116 | 600 mm | 10 |
| Item No  | EAN*  | Width       | Qty  |            |     |        |        |             |    |       |        |        |    |
| 51010  | 510109  | 400 mm      | 10   |            |     |        |        |             |    |       |        |        |    |
| 51011  | 510116  | 600 mm      | 10   |            |     |        |        |             |    |       |        |        |    |
|  | <p><b>Broomstick</b></p> <p>Rounded handle head, natural finished wood, 24 mm diameter.</p> <table border="1"> <thead> <tr> <th>Item No</th> <th>EAN*</th> <th>Length</th> <th>Qty</th> </tr> </thead> <tbody> <tr> <td>51012</td> <td>510123</td> <td>1400 mm</td> <td>10</td> </tr> </tbody> </table>   | Item No     | EAN* | Length     | Qty | 51012  | 510123 | 1400 mm     | 10 |       |        |        |    |
| Item No  | EAN*  | Length      | Qty  |            |     |        |        |             |    |       |        |        |    |
| 51012  | 510123  | 1400 mm     | 10   |            |     |        |        |             |    |       |        |        |    |
|   | <p><b>Root brush</b></p> <p>Genuine rice root fill, natural wooden block.</p> <table border="1"> <thead> <tr> <th>Item No</th> <th>EAN*</th> <th>Width</th> <th>Qty</th> </tr> </thead> <tbody> <tr> <td>51015</td> <td>510154</td> <td>220 mm</td> <td>10</td> </tr> </tbody> </table>   | Item No     | EAN* | Width      | Qty | 51015  | 510154 | 220 mm      | 10 |       |        |        |    |
| Item No  | EAN*  | Width       | Qty  |            |     |        |        |             |    |       |        |        |    |
| 51015  | 510154  | 220 mm      | 10   |            |     |        |        |             |    |       |        |        |    |
|   | <p><b>Industrial hand brush</b></p> <p>Real horse hair, natural wood handle.</p> <table border="1"> <thead> <tr> <th>Item No</th> <th>EAN*</th> <th>Width</th> <th>Qty</th> </tr> </thead> <tbody> <tr> <td>51006</td> <td>510062</td> <td>280 mm</td> <td>10</td> </tr> </tbody> </table>  | Item No     | EAN* | Width      | Qty | 51006  | 510062 | 280 mm      | 10 |       |        |        |    |
| Item No  | EAN*  | Width       | Qty  |            |     |        |        |             |    |       |        |        |    |
| 51006  | 510062  | 280 mm      | 10   |            |     |        |        |             |    |       |        |        |    |
|   | <p><b>Industrial hand brush</b></p> <p>Robust coco fibre fill, natural wood handle.</p> <table border="1"> <thead> <tr> <th>Item No</th> <th>EAN*</th> <th>Width</th> <th>Qty</th> </tr> </thead> <tbody> <tr> <td>51007</td> <td>510079</td> <td>280 mm</td> <td>10</td> </tr> </tbody> </table>   | Item No     | EAN* | Width      | Qty | 51007  | 510079 | 280 mm      | 10 |       |        |        |    |
| Item No  | EAN*  | Width       | Qty  |            |     |        |        |             |    |       |        |        |    |
| 51007  | 510079  | 280 mm      | 10   |            |     |        |        |             |    |       |        |        |    |

**Hand shovel**

Black laquered metal, natural wood handle.

| Item No | EAN*   | Dimensions   | Qty |
|---------|--------|--------------|-----|
| 51008   | 510086 | 420 x 220 mm | 10  |

**Refuse sacks**

PE, 10 sacks per roll, 58 µm material thickness.

| Item No | EAN*   | Capacity   | Qty |
|---------|--------|------------|-----|
| 8112    | 027201 | 120 litres | 10  |

**Removal blanket**

Hard-wearing removal blanket, robust fleece, non-roughed, 320 g/m<sup>2</sup>.

| Item No | EAN*   | Dimensions | Qty |
|---------|--------|------------|-----|
| 686     | 007791 | 1,5 x 2 m  | 8   |

**Dust protection door**

The pre-assembled foil door easily and quickly creates a dust-proof lock between spaces. The sewn-in zip ensures a permanent bond. The door guarantees optimal dust-proofing, with all around bonding to the frame. The foil door is suitable for all door frames up to a height of 2.1 m and a width of 1.1 m and can be used repeatedly.

- dustproof all round
- sewn-in zip
- rolled up door secured with hook and loop
- extra strong quality

| Item No | EAN*   | Dimensions | Qty |
|---------|--------|------------|-----|
| 71371   | 024996 |            | 10  |

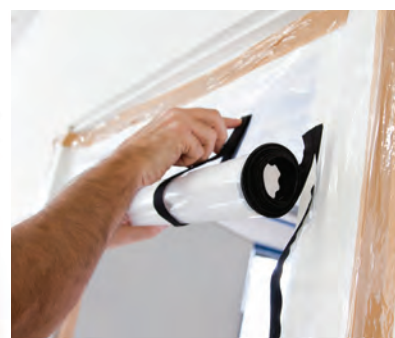
**Downpipe foil hose**

The tubular downpipe foil hose replaces the original downpipe in façade renovations and protects against moisture and dirt.

| Item No | EAN*   | Dimensions             | Qty |
|---------|--------|------------------------|-----|
| 72371   | 028949 | 200 x 0,14 mm x 150 lm | 1   |
| 72371K  | 031406 | 200 x 0,14 mm x 50 lm  | 1   |



# Health and safety



### Full-view protective glasses

Lightweight and comfortable. Extremely robust with good side protection, polycarbonate lenses provide good shock resistance. CE marking according to EN 166: 2001  
Item No 538g with bronze tinting for outdoor use.

| Item No              | EAN*   | Qty |
|----------------------|--------|-----|
| 538                  | 003847 | 1   |
| <b>Tinted lenses</b> |        |     |
| 538G                 | 003854 | 1   |



### Full-view protective glasses

Very lightweight wraparound polycarbonate frame provides good shock resistance and side protection. Can also be worn over prescription glasses. CE marking according to EN 166: 2001

| Item No | EAN*   | Qty |
|---------|--------|-----|
| 548     | 003922 | 1   |

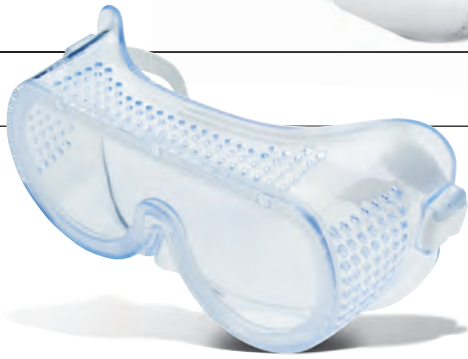

### Protective goggles

Transparent, soft PVC. Standard version.

| Item No | EAN*   | Qty |
|---------|--------|-----|
| 8535    | 705352 | 6   |



### Hard hat

Impact-resistant plastic, textile and polyamide straps, leather sweat-band, tested according to DIN 4840-2K.

| Item No | EAN*   | Colour | Qty |
|---------|--------|--------|-----|
| 539     | 505396 | yellow | 1   |
| 539W    | 026792 | white  | 1   |



### Hearing protection muffs

Plastic headband and ear-cups, removable ear cushions, noise-suppressing foam filling. PTB tested..

| Item No | EAN*   | Qty |
|---------|--------|-----|
| 529     | 505297 | 1   |



### Disposable coarse-dust mask

Comfortable fit and good protection against pesky, non-toxic coarse dust. Made from hygienic filter fabric. Easy breathing through large filtering surface. Adjustable through the flexible nose bridge to any face shape. NO respiratory protection!

| Item No | EAN*   | Qty |
|---------|--------|-----|
| 534     | 505341 | 50  |

| Dust Masks   |        |       |        |     |
|--|--------|-------|--------|-----|
| Comfortable and skin-friendly disposable masks, made of highest quality materials. High comfort, low breathing resistance, lightweight material. With colour-coded exhalation valve, thereby significantly reducing the likelihood of confusion. Protect against non-toxic fine dust particles and fibres as well as against solid and water based aerosols. Comply with the standard EN149: 2001 + A1: 2009 (FFP1 NR FFP2 NR, FFP 3 NR) |        |       |        |     |
| Item no  | EAN*   | Level | Colour | Qty |
| 531/1  | 028796 | FFP1  | yellow | 10  |
| 531/2  | 028802 | FFP2  | orange | 10  |
| 531/3  | 028819 | FFP3  | red    | 10  |



| Areas of use                      | Protection level FFP1 NR | Protection level FFP2 NR | Protection level FFP3 NR |
|-----------------------------------|--------------------------|--------------------------|--------------------------|
| Rust                              | ■                        | ■                        | ■                        |
| Portland cement                   |                          | ■                        | ■                        |
| Cellulose filler/plaster of Paris | ■                        | ■                        | ■                        |
| Brick/concrete dust               | ■                        | ■                        | ■                        |
| Hardwood                          |                          | ■                        | ■                        |
| Softwood                          |                          | ■                        | ■                        |
| Paint/lacquers/varnishes          |                          | ■                        | ■                        |
| Corrosion protection              |                          | ■                        | ■                        |
| Anti-fouling-lacquers             |                          |                          | ■                        |
| Stone/Concrete dust below VdGW    | ■                        | ■                        | ■                        |
| Stone/Concrete dust above VdGW    |                          | ■                        | ■                        |
| Iron dust                         | ■                        | ■                        | ■                        |
| Steel dust, highly alloyed        |                          |                          | ■                        |
| Cobalt/Beryllium dust             |                          |                          | ■                        |
| Coolant lubrication particles     |                          | ■                        | ■                        |
| <b>Welding</b>                    |                          |                          |                          |
| Welding smoke, non-alloy          |                          | ■                        | ■                        |
| Welding smoke, high-alloy         |                          |                          | ■                        |
| Welding smoke, zinc               |                          | ■                        | ■                        |
| Soldering                         |                          |                          | ■                        |
| Asbestos                          |                          |                          | ■                        |
| Working with fibre glass/mineral  |                          | ■                        | ■                        |

| Areas of use                    | Protection level FFP1 NR | Protection level FFP2 NR | Protection level FFP3 NR |
|---------------------------------|--------------------------|--------------------------|--------------------------|
| <b>Cleaning</b>                 |                          |                          |                          |
| Dust                            | ■                        |                          |                          |
| Herbicides/pesticides solutions |                          | ■                        | ■                        |
| <b>Handling of</b>              |                          |                          |                          |
| Mould/fungii                    |                          | ■                        | ■                        |
| Bacteria                        |                          | ■                        | ■                        |
| Diesel soot/smoke               |                          | ■                        | ■                        |

Please note: proposals listed in the filter table are only selected to the best of our knowledge. It is expressly pointed out that given the exact substance a detailed request must be submitted.

| Overall  |        |       |     |
|--|--------|-------|-----|
| Polypropylene, with hood, zip and elasticated back, breathable, snags and abrasion resistant, waterproof, washable. Sizes 50-60. |        |       |     |
| Item No  | EAN*   | Level | Qty |
| 542 LN   | 505426 | 50/52 | 10  |
| 542 XLN  | 505433 | 54/56 | 10  |
| 542 XXLN   | 505440 | 58/60 | 10  |

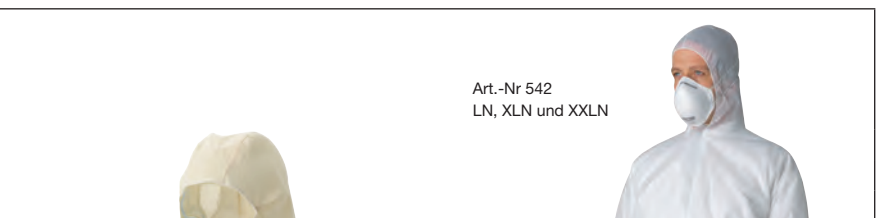

| Head protection hood   |        |       |     |
|--|--------|-------|-----|
| Light-weight, breathable, washable thin nettle cloth fabric, long, closed model. |        |       |     |
| Item No  | EAN*   | Level | Qty |
| 537  | 505372 |       | 10  |



| Overshoes   |        |       |       |
|---|--------|-------|-------|
| Made from Corovin, elasticated, breathable, snags and abrasion resistant, waterproof, washable. (5 pairs = 1 set) |        |       |       |
| Item No   | EAN*   | Level | Qty   |
| 549   | 001560 |       | 1 set |





| <b>Protective gloves, nitrile</b>  |        |      |     |
|--|--------|------|-----|
| Flock lined, rougher palm area for good grip even when wet, tactile, good abrasive resistance, temperature stable, good resistance against a variety of hazardous materials. EN 388 - Category 3 |        |      |     |
| Item No  | EAN*   | Size | Qty |
| 541A/10  | 554110 | 10   | 5   |



| <b>Cotton gloves, nitrile</b>  |        |      |     |
|--|--------|------|-----|
| Nitrile gloves, yellow coating, knitted cuff, non covered back of hand, according to EN 388 - Category 2. Very good abrasive and cut resistance, flexible, good fit and comfort. |        |      |     |
| Item No  | EAN*   | Size | Qty |
| 8541C  | 666165 | 10   | 12  |



| <b>Cotton gloves</b>   |        |      |     |
|--|--------|------|-----|
| Cotton gloves, medium-duty quality, raw white, knitted cuff. |        |      |     |
| Item No  | EAN*   | Size | Qty |
| 541E   | 554196 |      | 12  |



| <b>PU gloves</b>  |        |      |     |
|---|--------|------|-----|
| PU-coated nylon knitted gloves, back of hand and top of fingers not covered, according to EN 388 - Category 2, colour: white. Very good fit, very flexible, abrasion resistant. |        |      |     |
| Item No   | EAN*   | Size | Qty |
| 8541PU/10   | 016380 | 10   | 12  |



| <b>Latex gloves</b>   |        |      |     |
|---|--------|------|-----|
| Latex household gloves, yellow, non-sterile, chlorinated, ingrained scales pattern. |        |      |     |
| Item No   | EAN*   | Size | Qty |
| 8541U   | 630289 | 10   | 10  |



| <b>Chrome-leather gloves</b>   |        |      |     |
|--|--------|------|-----|
| Cowhide gloves, non-stained, lined, white drill, twin seams, according to EN 388 - Category 2. |        |      |     |
| Item No  | EAN*   | Size | Qty |
| 541H   | 554226 | 10   | 12  |



Please note: image scale of products may vary.

| Construction gloves   |        |      |     |
|---|--------|------|-----|
| Nylon knitted gloves, Nitrile-coated, grey/black, back of hand and top of fingers not covered, according to EN 388 - Category 2.<br>Good ergonomical fit and flexibility for high comfort, good wet and dry grip, abrasion resistant. |        |      |     |
| Item No   | EAN*   | Size | Qty |
| 541M  | 028826 | 10   | 12  |



| Construction gloves   |        |      |     |
|---|--------|------|-----|
| As Item No: 541M, but with rougher palm area for good grip. Standard version. |        |      |     |
| Item No   | EAN*   | Size | Qty |
| 8541M   | 028833 | 10   | 12  |



| Cut-protection gloves   |        |      |     |
|---|--------|------|-----|
| Seamless fibreglass and Nylon knitted gloves, with patented micro nitrile-foam coating, grey back of hand and top of fingers not covered, according to EN 388 - Category 2. Highly breathable, high cut resistance, very good ergonomical fit and flexibility |        |      |     |
| Item No   | EAN*   | Size | Qty |
| 541S  | 028840 | 10   | 12  |



| Beaded gloves   |        |      |     |
|---|--------|------|-----|
| <b>541F</b><br>Cotton, black PVC beads, abrasion resistant, good grip.  |        |      |     |
| <b>541F2</b><br>Cotton/polyester medium knit gloves, grey, palmside with red PVC beads. according to EN 388 - Category 2. |        |      |     |
| Item No   | EAN*   | Size | Qty |
| 541F  | 554202 | 10   | 12  |
| 541F2   | 028857 | 10   | 12  |



| Disposable gloves   |        |                 |     |
|---|--------|-----------------|-----|
| High quality vinyl, protection against oils, fats, skin-irritating substances, light lye or acid, varnishes, dirt, etc.<br>1 box = 50 pairs |        |                 |     |
| <b>541N/3</b> blue Nitrile  |        |                 |     |
| Item No   | EAN*   | Size / Version  | Qty |
| 541D/2  | 554165 | L powdered      | 1   |
| 541D/3  | 554172 | XL powdered     | 1   |
| 541N/3  | 019428 | XL non-powdered | 1   |



| First-aid box  |        |  |     |
|--|--------|--|-----|
| Content according to DIN 13157. For mobile and stationary use. |        |  |     |
| Item No  | EAN*   |  | Qty |
| 71374  | 025375 |  | 1   |



# Measuring devices

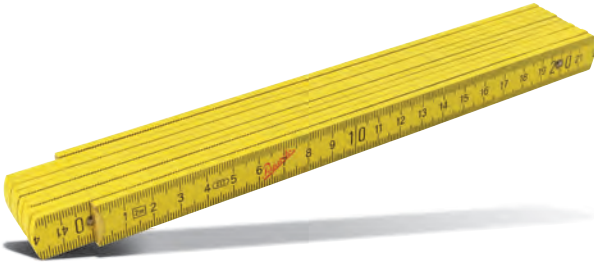

**Wooden folding rule**

Yellow laquered, mm-graduation, scratch resistant, brass end caps and strike plates, 10 folds, 16 mm width.

| Item No    | EAN*   | Length | Qty |
|------------|--------|--------|-----|
| <b>122</b> | 512202 | 2 m    | 12  |



**Plastic folding rule**

Fibreglass reinforced polyamide, mm-graduation, durable joints, lockable at right-angle. 10 folds, 16 mm width.

| Item No     | EAN*   | Length | Qty |
|-------------|--------|--------|-----|
| <b>122K</b> | 512226 | 2 m    | 12  |



**Tape measure**

Laquered steel band, 12 mm width, mm-graduation, plastic casing. Standard version.

| Item No       | EAN*   | Length | Qty |
|---------------|--------|--------|-----|
| <b>8223/3</b> | 680239 | 3 m    | 12  |
| <b>8223/5</b> | 029007 | 5 m    | 12  |



**Aluminium spirit level**

Polished rectangular aluminium profile, 100 x 18 mm, with one each horizontal and vertical perspex bubble. The 2-metre version also has 2 handle holes.

| Item No        | EAN*   | Length  | Qty |
|----------------|--------|---------|-----|
| <b>835/1,5</b> | 583516 | 1500 mm | 1   |
| <b>835/2</b>   | 583523 | 2000 mm | 1   |



**Light-alloy spirit level**

Polished rectangular light-alloy profile, 50 x 23 mm, with one each horizontal and vertical perspex bubble.

| Item No        | EAN*   | Length  | Qty |
|----------------|--------|---------|-----|
| <b>332/30</b>  | 533207 | 300 mm  | 1   |
| <b>332/40</b>  | 533214 | 400 mm  | 1   |
| <b>332/50</b>  | 533221 | 500 mm  | 1   |
| <b>332/60</b>  | 533238 | 600 mm  | 1   |
| <b>332/80</b>  | 533245 | 800 mm  | 1   |
| <b>332/100</b> | 533252 | 1000 mm | 1   |
| <b>332/120</b> | 533269 | 1200 mm | 1   |
| <b>332/150</b> | 533276 | 1500 mm | 1   |
| <b>332/200</b> | 533283 | 2000 mm | 1   |



**h-shaped profiles**

Aluminium profile, 2 mm thickness, 115 x 25 mm, reinforcing beading at the edges.

| Item No        | EAN*   | Length  | Qty |
|----------------|--------|---------|-----|
| <b>838/150</b> | 508397 | 1500 mm | 1   |
| <b>838/200</b> | 508366 | 2000 mm | 1   |

**Made in Germany**  
Made by Pajarito

Please note: image scale of products may vary.



# LED accumulator lamps

## Accumulator LED 10 Watt

900 lm, dimmable, Li-Ion battery 5.2 Ah with magnetic feet Luminance: 5500-6000 K (cold white) Protection class: IP65 Temperature range: charging 0 to 45 °C / function -20 to 50 °C 6 hours charging time with 4 different brightness levels (Operation times): 100 % light = 6 hours, 50 % light = 12 hours, 25 % light = 24 hours, flashing light = 6 hours Alternatively, mains operation possible incl. 230 V power supply unit and car charging cable

| Item No | EAN*   | Dimensions:        | Qty |
|---------|--------|--------------------|-----|
| 77043N  | 032809 | 145 x 160 x 270 mm | 1   |



## Accumulator LED 10 Watt Set

900 lm, dimmable, 2 Li-Ion exchangeable batteries 5.2 Ah, retaining bracket for rapid battery change, USB socket (e.g. for charging a mobile phone) and magnetic feet Luminance: 5500-6000 K (cold white) Protection class: IP44 Temperature range: charging 0 to 45 °C / function -20 to 50 °C 6 hours charging time with 4 different brightness levels (Operation times): 100 % light = 6 hours, 50 % light = 12 hours, 25 % light = 24 hours, flashing light = 6 hours Incl. 2 Li-Ion batteries, 230 V power supply unit and car charging cable

| Item No | EAN*   | Dimensions:        | Qty |
|---------|--------|--------------------|-----|
| 77045N  | 032823 | 145 x 160 x 270 mm | 1   |



## Accumulator LED 20 Watt

1800 lm, dimmable, Li-Ion battery 8.8 Ah Luminance: 5500-6000 K (cold white) Protection class: IP65 Temperature range: charging 0 to 45 °C / function -20 to 50 °C 5 hours charging time with 4 different brightness levels (Operation times): 100 % light = 3 hours, 50 % light = 6 hours, 25 % light = 12 hours, flashing light = 3 hours Alternatively, mains operation possible incl. 230 V power supply unit and car charging cable

| Item No | EAN*   | Dimensions:        | Qty |
|---------|--------|--------------------|-----|
| 77046N  | 032830 | 215 x 185 x 285 mm | 1   |



## Tripod suitable for 10 & 20 Watt spots

3-legged tripod for accumulator LED spotlight:  
For 1 to 2 20W spots or for 1 to 3 10W spots

| Item No | EAN*   | Dimensions: | Qty |
|---------|--------|-------------|-----|
| 77044N  | 032816 | 67-150 cm   | 1   |



## Accumulator LED 30 Watt

2700 lm, dimmable, Li-Ion battery 8.8 Ah Luminance: 5500-6000 K (cold white) Protection class: IP65 Temperature range: charging 0 to 45 °C / function -20 to 50 °C 6 - 8 hours charging time with 3 different brightness levels (Operation times): 100 % light = 3 hours, 50 % light = 6 hours, 25 % light = 12 hours Alternatively, mains operation possible incl. 230 V power supply unit and car charging cable

| Item No | EAN*   | Dimensions:        | Qty |
|---------|--------|--------------------|-----|
| 77047N  | 032847 | 300 x 225 x 370 mm | 1   |



## Accumulator LED 50 Watt

4500 lm, dimmable, Li-Ion battery 6.6 Ah Luminance: 5500-6000 K (cold white) Protection class: IP65 Temperature range: charging 0 to 45 °C / function -20 to 50 °C 6 - 8 Std. hours charging time with 3 different brightness levels (Operation times): 100 % light = 3 hours, 50 % light = 6 hours, 25 % light = 12 hours Alternatively, mains operation possible incl. 230 V power supply unit and car charging cable

| Item No | EAN*   | Dimensions:        | Qty |
|---------|--------|--------------------|-----|
| 77048N  | 032854 | 360 x 237 x 375 mm | 1   |



# Pajarito Teletower



Length: 80cm - width: 46cm - height: 104cm

### Pajarito Teletower

The telescopic mechanism allows 5 adjustable scaffold heights of 1-2 meters (working height 3-4 meters). Large slip-resistant work platform made of aluminum (1.40 m x 0.70 m) with access hatch. Set up in less than 3 minutes, saving working time. Can be transported in a station wagon or small van. Minimal footprint for easy transport and storage. Can be used as a podium with 33 cm and 61 cm height. EN1004 compliant. Comes in only two parts. No long searching for all the parts. Integral stabilising legs with 5 optional positions and lockable castors. Adjustable with two spirit levels. Inscrutable board rails all around for your safety (a requirement for platforms 1.5 meter height and above). Safety railing around it to protect your hands and knees. Platform stabilizers.

| Item No | EAN*   | Qty |
|---------|--------|-----|
| 6008    | 004738 | 1   |

6



Please note: image scale of products may vary.

# Pajarito Teletower





## That special something is quite normal

7

**Special manufactures and new developments, specific applications and exceptional solutions: that is the world of Pajarito.**

Exceptional tasks require exceptional tools. Since we know this, we apply our expertise to strengthen your performance as best we can with the appropriate tools. Our experts are consistently developing new innovative products for the trade and industry. Our ranges also include special manufacturers tailored to customer specifications and, of course,

everything in a certified top quality. Just contact us: we will be pleased to be of assistance!

**Tools from Pajarito:  
made for you!**

# Machines and accessories laser technology, measuring instruments

Our highlight product: **PAJARITO-Power-Perfo:**  
Perforates with its own drive.



Best of Pajarito! PAJARITO-Power-Perfo is self-propelled, has 6 perforating wheels and can be adjusted from 1000 to 2000 revolutions. Yet, amazingly easy to handle. Full power for professional perforating! Made in Germany – Made by Pajarito.

PAJARITO-Power-Perfo can be found on page 162.



PAJARITO Stripper on page 163



Sanding machines on page 164



Sanding accessories from page 164



Precision measuring from page 170

# Power-Perfo

**Go anywhere!**

For easy removal of wall coverings.



**Made in Germany**  
**Made by Pajarito**

**Made in Germany**  
**Made by Pajarito**

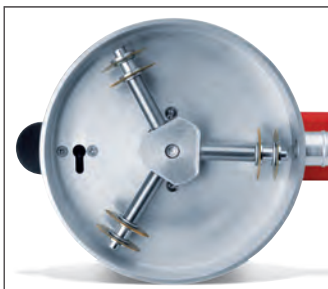

**Made in Germany**  
**Made by Pajarito**



### Power-Perfo

Professional perforating of all kinds of wallcoverings (except fibreglass) on any surfaces. Simply placed on the wall, moved in straight lines over the covering. Perforation depth is individually adjustably to the covering thickness. The regular perforations allow wallpaper remover to penetrate quicker and over larger areas.

#### Specifications:

230 V/50 Hz, 500 W, 1000 to 2000 rpm  
Weight: 3200 g

**Content:** systainer, with adjustment tools and hearing protection

| Item No | EAN*   | Qty |
|---------|--------|-----|
| 1000    | 012023 | 1   |

#### Spare perf. wheels for Power-Perfo

1 set = 6 pcs

|       |        |   |
|-------|--------|---|
| 1000E | 012030 | 1 |
|-------|--------|---|

### Grinding set for Power-Perfo

Complete grinding unit for grinding and smoothing professionally. Ideal for drywall construction: smoothing plaster seams and uneven surfaces. Holder disc, grinding wheels and abrasive mesh have a diameter of 178 mm and holes for dust extraction. Quick application with hook and loop, grinding discs and abrasive mesh grits range from 60 to 180. All in a practical and robust case.

Weight: 950 g.

Set content:

- 1x holder with hook and loop pad, 178 mm dia.
- 2x grinding disc (Item No. 1854E / 60)
- 2x grinding disc (Item No. 1854E / 80)
- 2x grinding disc (Item No. 1854E / 100)
- 2x grinding disc (Item No. 1854E / 120)
- 1x sanding grid (Item No. 1871E / 100)
- 1x sanding grid (Item No. 1871E / 180)
- 1x plastic case

| Item No | EAN*   | Diameter | Qty |
|---------|--------|----------|-----|
| 1001    | 015680 | 178 mm   | 1   |

Please note: image scale of products may vary.

# Flooring destroyer

## More strokes!

Pajarito Stripper –  
unstoppable.

### Pajarito Stripper

Professional tool for removal of floor covering, larger stroke than conventional devices, adjustable angle of the cutting blade 15°, 20°, 25°. Powerful drive with starting current limitation. Device can be separated from the chassis for manual operation.

**Content:** Pajarito Stripper, 1 cutting blade, tool kit, protective gloves and hearing protection.

**Specification:** 230 V / 50 Hz, 2000 W, 20 kg, 8500 strokes / min.

| Item No                                | EAN*   | Qty |
|--|--------|-----|
| 61011                                  | 012047 | 1   |
| <b>Spare blade (no illustration)</b>   |        |     |
| 61011E                                 | 012054 | 10  |
| <b>Transport box (no illustration)</b> |        |     |
| 61012                                  | 012061 | 1   |



**III Made in Germany**  
**Made by Pajarito**

# Hand mixer

### Hand mixer EH R 18 S Set

Universal mixer up to 40 kg, for mixing materials with low and medium viscosity, e.g. paint, glue, smoothing and leveling compounds, tile adhesive, ready-mixed mortar. With electronic switch for infinitely variable speed adjustment for low-spray mixing.

Cap with labyrinth guide for protection against dirt, stones, splashing, etc.

M 14 direct connection - high power transmission, high concentricity.

| Item No | EAN*   | Qty |
|---------|--------|-----|
| 50280   | 503866 | 1   |

### Specifications EH R 18 S Set

|                            |                      |
|----------------------------|----------------------|
| Power consumption          | 1100 W               |
| Rated voltage              | 230 V ~              |
| Rated speed                | 0-450 min-1          |
| Idle speed                 | 800 min-1            |
| Mixing paddle diameter     | 120 mm               |
| Tool fixture               | M 14 internal thread |
| Weight                     | 4.1 kg               |
| Supplied in a box          |                      |
| incl. mixing paddle WG 120 |                      |



# Strong performance

## Dust-free sanding!

High capacity machine for grinding, polishing and wet-cleaning.



Art.-Nr. 62800

### Single disc grinding machine PLANA

Very powerful machine with steel gears for dust-free sanding screeds and screeded sub-floors as well as for wet cleaning of hard floors and carpets and polishing of hard floors. Can also be used for intermediate sanding of parquets.

#### Specifications:

220-240 V, 1600 W, 154 rpm, 42 kg.

#### Content:

Grinding-machine PLANA, without disc.

| Item No | EAN*   | Working width | Qty |
|---------|--------|---------------|-----|
| 62800   | 017387 | 375 - 400 mm  | 1   |



Art.-Nr. 62801

Art.-Nr. 62804

Vacuum set  
Item No 62803

Art.-Nr. 62802

### Accessories for PLANA

#### Additional weight

To attach to the machine.

| Item No | EAN*   | Weight | Qty |
|---------|--------|--------|-----|
| 62801   | 017394 | 10 kg  | 1   |

#### Vacuum ring

To attach to an external vacuum cleaner.

|       |        |             |   |
|-------|--------|-------------|---|
| 62802 | 017400 | Vacuum ring | 1 |
| 62803 | 018933 | Vacuum set  | 1 |
| 62804 | 024675 | Tank        | 1 |

# Disc holders and abrasives

7



### Disc holder with rubber-foam padding 405 mm diameter

To hold abrasive paper discs.

| Item No | EAN*   | Diameter | Qty |
|---------|--------|----------|-----|
| 61521   | 014423 | 405 mm   | 1   |

### Spare rubber foam-padding (no illus.)

|        |        |        |   |
|--------|--------|--------|---|
| 61521E | 017196 | 405 mm | 1 |
|--------|--------|--------|---|

### Disc holder with rubber-foam padding 420 mm diameter

To hold abrasive paper discs.

| Item No | EAN*   | Diameter | Qty |
|---------|--------|----------|-----|
| 61522   | 014416 | 420 mm   | 1   |

### Spare rubber foam-padding (no illus.)

|        |        |        |   |
|--------|--------|--------|---|
| 61522E | 017202 | 420 mm | 1 |
|--------|--------|--------|---|

Please note: image scale of products may vary.

**Abrasive paper disc, 375 mm dia.**

Double-sided, 40 mm bore.

| Item No | EAN*   | Grain | Qty |
|---------|--------|-------|-----|
| 61149   | 750499 | 16    | 10  |
| 61150   | 750451 | 24    | 10  |
| 61151   | 750468 | 40    | 10  |
| 61152   | 750475 | 60    | 10  |
| 61153   | 750482 | 80    | 10  |
| 61154   | 015321 | 100   | 10  |

**Abrasive paper disc, 400 mm dia.**

Double-sided, 25 mm bore.

| Item No | EAN*   | Grain | Qty |
|---------|--------|-------|-----|
| 61156   | 000402 | 16    | 10  |
| 61157   | 650862 | 24    | 10  |
| 61158   | 650966 | 40    | 10  |
| 61159   | 641520 | 60    | 10  |
| 61160   | 000396 | 80    | 10  |
| 61161   | 015338 | 100   | 10  |

**Abrasive paper disc, 430 mm dia.**

Double-sided, 30 mm bore.

| Item No | EAN*   | Grain | Qty |
|---------|--------|-------|-----|
| 61175   | 012641 | 16    | 10  |
| 61176   | 012658 | 24    | 10  |
| 61172   | 012665 | 40    | 10  |
| 61173   | 012672 | 60    | 10  |
| 61174   | 012689 | 80    | 10  |
| 61177   | 015345 | 100   | 10  |

**HM grinding disc 874, 380 mm dia.**

Double-sided, for abrading of screed and fillers and to remove glue and flooring residue. High removal rate.

| Item No   | EAN*   | Grain     | Qty |
|-----------|--------|-----------|-----|
| 874/380/G | 501688 | Coarse 10 | 1   |
| 874/380/M | 501657 | Medium 14 | 1   |
| 874/380/F | 501626 | Fine 24   | 1   |

**HM grinding disc 874, 400 mm dia.**

Double-sided, for abrading of screed and fillers and to remove glue and flooring residue. High removal rate.

| Item No   | EAN*   | Grain     | Qty |
|-----------|--------|-----------|-----|
| 874/400/G | 501763 | Coarse 10 | 1   |
| 874/400/M | 501756 | Medium 14 | 1   |
| 874/400/F | 501701 | Fine 24   | 1   |

**HM grinding disc 874, 430 mm dia.**

Double-sided, for abrading of screed and fillers and to remove glue and flooring residue. High removal rate.

| Item No   | EAN*   | Grain     | Qty |
|-----------|--------|-----------|-----|
| 874/430/G | 501794 | Coarse 10 | 1   |
| 874/430/M | 501787 | Medium 14 | 1   |
| 874/430/F | 501770 | Fine 24   | 1   |

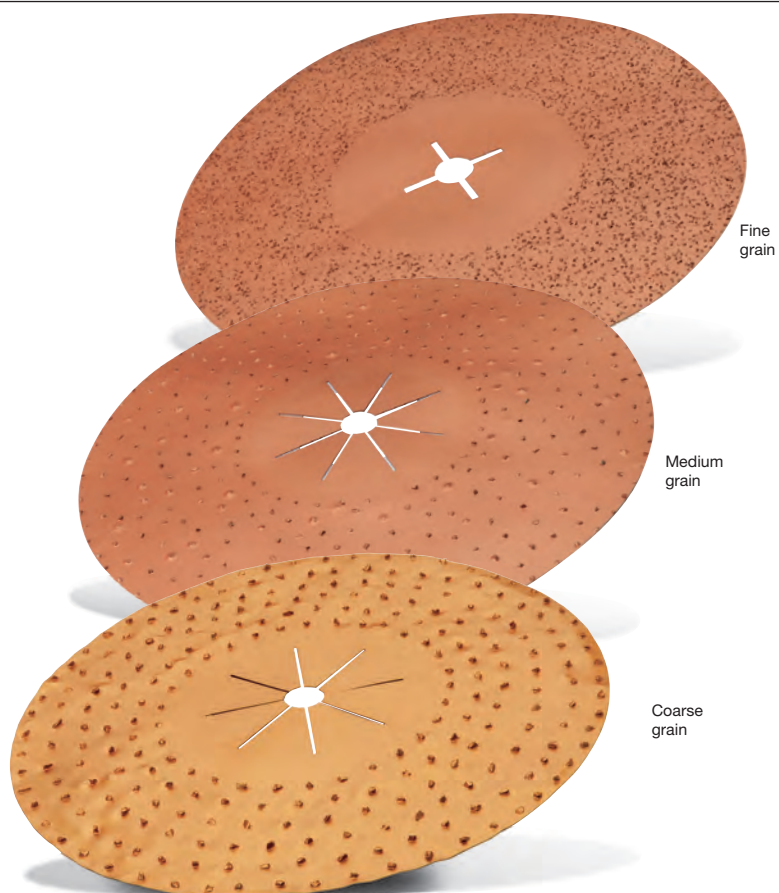

# Disc-holders and abrasives

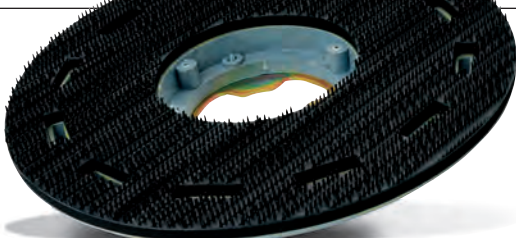

| Disc holder                    |        |             |     |
|--------------------------------|--------|-------------|-----|
| Takes pads and abrasive gauze. |        |             |     |
| Item No                        | EAN*   | Durchmesser | Qty |
| 61525                          | 014447 | 405 mm      | 1   |
| 61526                          | 014430 | 420 mm      | 1   |



| Cleaning pads, 400 mm diameter   |        |           |     |
|--|--------|-----------|-----|
| Basic cleaning (black), maintenance cleaning (green), polishing (white). |        |           |     |
| Item No  | EAN*   | Thickness | Qty |
| 61138 black  | 750529 | 10 mm     | 10  |
| 61139 green  | 750536 | 10 mm     | 10  |
| 61140 white  | 750543 | 10 mm     | 10  |



| Super pads, 400 mm diameter  |        |           |     |
|--|--------|-----------|-----|
| Basic cleaning (black), maintenance cleaning (green), polishing (white). |        |           |     |
| Item No  | EAN*   | Thickness | Qty |
| 61141 black  | 750550 | 20 mm     | 5   |
| 61142 green  | 750567 | 20 mm     | 5   |
| 61143 white  | 750574 | 20 mm     | 5   |



| Abrasive gauze, 400 mm diameter |        |       |     |
|---------------------------------|--------|-------|-----|
| Double-sided.                   |        |       |     |
| Item No                         | EAN*   | Grain | Qty |
| 61163                           | 750581 | 60    | 10  |
| 61164                           | 750598 | 80    | 10  |
| 61165                           | 750604 | 100   | 10  |
| 61166                           | 750611 | 120   | 10  |
| 61167                           | 750628 | 180   | 10  |

7

Please note: image scale of products may vary.

# Grinding discs and brushes

## Grinding disc, 6 rectangular stones

Grinding of screed and filler, removal of paint, plaster and uneven patches. With 6 exchangeable, rectangular grinding stones, 420 mm diameter.

| Item No | EAN*   | Grain | Qty |
|---------|--------|-------|-----|
| 61170   | 014515 | 20    | 1   |

### Set of replacement grinding stones

6 pieces incl. mounting material.

|        |        |    |     |
|--------|--------|----|-----|
| 61170E | 014539 | 20 | Set |
|--------|--------|----|-----|



## Grinding disc, 5 round stones

Grain 24, for grinding of hard filler, screed and concrete, the hollow built always guarantees sharp edges, 420 mm diameter.

| Item No | EAN*   | Grain | Qty |
|---------|--------|-------|-----|
| 61171   | 014522 | 24    | 1   |

### Set of replacement grinding stones

5 pieces incl. mounting material.

|        |        |    |     |
|--------|--------|----|-----|
| 61171E | 014546 | 24 | Set |
|--------|--------|----|-----|



## Grinding disc with grinding stone ring

Grinding of screed and filler, 40 mm thickness of the stone ring, 400 mm disc diameter.

| Item No | EAN*   | Grain | Qty |
|---------|--------|-------|-----|
| 61639   | 014492 | 24    | 1   |



## Cleaning brush

Hard, white nylon bristles, for cleaning of hard flooring.

| Item No | EAN*   | Diameter | Qty |
|---------|--------|----------|-----|
| 61633   | 014461 | 410 mm   | 1   |

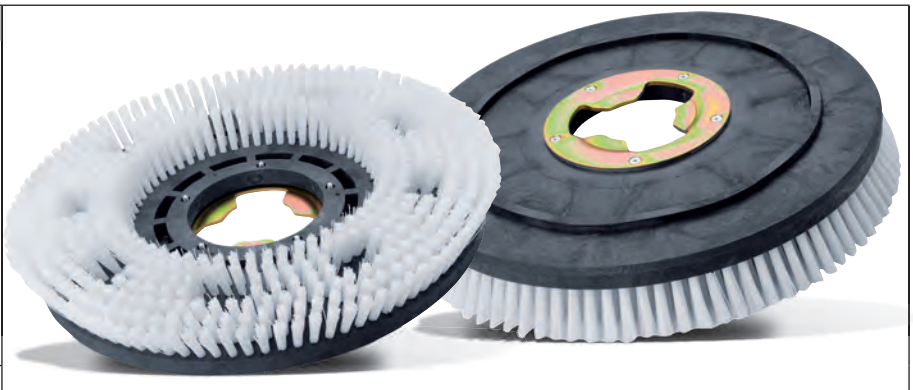

# Corrugated links and scorers

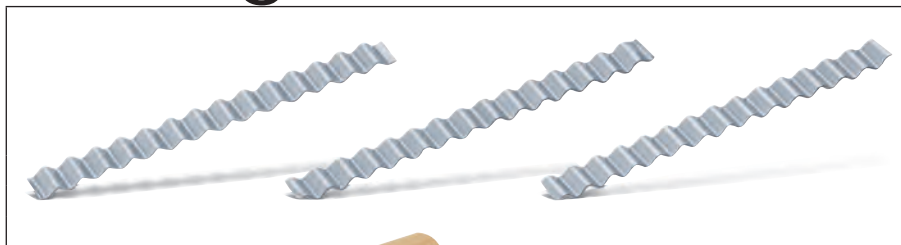

| Corrugated links  |        |  |      |
|---|--------|--|------|
| Strong filling of gaps in screed, in conjunction with epoxy filler. |        |  |      |
| Item No   | EAN*   |  | Qty  |
| 61520   | 503132 |  | 1000 |
| 61530   | 541127 |  | 100  |



| Scorer  |        |  |     |
|---|--------|--|-----|
| For checking the strength of the screed. With the scoring method 3 parallel lines are etched in an angle of 40 to 60° into the screed. The resulting grid scoring pattern and the possibly existing breakage where the lines cross, the strength of the screed can be assessed. |        |  |     |
| <b>Content:</b> scribe, scribe template, protective cover.  |        |  |     |
| Item No   | EAN*   |  | Qty |
| 62700   | 016328 |  | 1   |

# Hand welding appliance



| Hot air tool HG 2620 E  |               |
|---|---------------|
| 2300 W, digital temperature adjustment from 50 – 700 °C in 10 °C steps with joystick Air volume control from 150 – 600 l/min Equipped with LCD display and remaining heat indicator Brushless motor, integrated fine dust filter, suitable for building sites Ergonomic handle design with soft-touch application and magnesium, protective tube for safe working |               |
| <b>Technical Data:</b>  |               |
| Mains connection: 220 – 230 V, 50/60 Hz   |               |
| Output: 2300 W  |               |
| High-performance brushless motor (10,000h)  |               |
| Temperature: 50 – 700 °C  |               |
| Air volume: 150 – 600 l/min   |               |
| Air pressure: 4.000 Pa  |               |
| Temperature adjustment: continuous (in 10 °C steps) Protection class (without protective earth connection): II  |               |
| Heating: ceramic heating  |               |
| Thermo protection: yes  |               |
| Dimensions (L x B x H): 358 x 91 x 95 mm  |               |
| Weight: 0.840 kg (without mains cable)  |               |
| <b>Scope of delivery:</b>   |               |
| HG 2620 E, plastic case   |               |
| Item No.  | EAN*          |
| 351809  | 4007841351809 |

7



| Accessories for HG 2620 E                     |               |
|---|---------------|
| <b>Circular nozzle 5 mm</b>                   |               |
| 092214  | 4007841092214 |
| <b>Circular nozzle 10 mm for Welding shoe</b> |               |
| 092313  | 4007841092313 |
| <b>Welding shoe</b>                           |               |
| 075316  | 4007841075316 |
| <b>Angled flat nozzle 20 x 2 mm</b>           |               |
| 092115  | 4007841092115 |
| <b>Angled flat nozzle 40 x 2 mm</b>           |               |
| 092016  | 4007841092016 |

Art.-Nr. 092214 = 5 mm  
Art.-Nr. 092313 = 10 mm

Art.-Nr. 075316

Art.-Nr. 092016

Art.-Nr. 092115

Please note: image scale of products may vary.



**NOVUS**<sup>®</sup>

**STEINEL**<sup>®</sup>  
PROFESSIONAL



We carry the complete Steinel Novus range!  
Our sales team is there to advise you.  
Catalogue orders phone +49 2104 / 30000

# Mould detector



Thanks to its dew point display, the mould detector can identify mould-endangered areas immediately and detect concealed and invisible thermal bridges. The comprehensive range of performance features and its simple handling make the appliance ideal for mobile applications.



**Mould warning**



**Thermal bridge detection**



everything at a glance



**Technical data**

LCD display with backlight  
Detector thermopile  
Measurement optics: 12:1  
Measuring range: -20–350 °C, infrared  
-10–40 °C, with ambient sensor  
Object: -20–10 °C and 30–200°C:  
Emissivity: 0.75, 0.85 and 0.95, pre-set  
Resolution: 0.1 °  
Response time: < 0.5 s  
Auto-Power-Off after approx. 25 s  
Data-Hold-Function: yes  
Operating temperature: -10–40 °C, -14–140 °F  
Humidity: 10–90 % RH  
Laser class II, 650 nm, <1 mW  
Housing: impact resistant and break-proof ABS plastic material  
Power supply: 1 x 9 V  
Scope of delivery: incl. battery and ever-ready case

**Mould detector**

Surface temperature measurement  
Dew point calculation!  
Mould warning!

| Art.-Nr. | EAN*   | VE |
|----------|--------|----|
| 6072     | 016298 | 1  |



# Precise temperature



| Laser thermometer   |        |  |     |
|---|--------|--|-----|
| Precise temperature measurement by laser spot, measuring range -20 to 380 ° C. Automatic energy saving, laser turn-off point, switchable backlight, data hold function. Lightweight, ergonomic shape. TÜV-GS tested and approved EN61010-1. |        |  |     |
| <b>Content:</b><br>Incl. batteries and carrying case.   |        |  |     |
| Item No   | EAN*   |  | Qty |
| 6071  | 016281 |  | 1   |

| Laser thermometer with external feeler connection ( K-Type )   |        |  |     |
|--|--------|--|-----|
| Precise temperature measurement by laser spot, measuring range -60 to 500 ° C. Automatic energy saving, laser turn-off point, switchable backlight, data hold function. Switchable LED flashlight, Min-Max value memory. TÜV-GS tested and approved, IEC / EN 61010-1. |        |  |     |
| <b>Content:</b><br>Incl. batteries and carrying case.  |        |  |     |
| Item No  | EAN*   |  | Qty |
| 6073   | 016403 |  | 1   |

# Layer thickness gauges

|  <p>Made in Germany<br/>Made by Pajarito</p>  | <p><b>Wet-coat measuring gauge, stainless</b></p> <p>Stainless steel, rhombus shape, laser inscribed, measuring range 25 to 2000 µm.</p> <table border="1"> <thead> <tr> <th>Item No</th> <th>EAN*</th> <th></th> <th>Qty</th> </tr> </thead> <tbody> <tr> <td>5555/R</td> <td>016434</td> <td></td> <td>1</td> </tr> </tbody> </table>   | Item No | EAN* |  | Qty | 5555/R | 016434 |  | 1 |
|---|---|---------|------|--|-----|--------|--------|--|---|
| Item No   | EAN*  |         | Qty  |  |     |        |        |  |   |
| 5555/R  | 016434  |         | 1    |  |     |        |        |  |   |
|    | <p><b>Thickness meter up to 2000µm</b></p> <p>Rugged plastic housing, UV-resistant and splash-proof. Measures all non magnetic coatings, e.g. paint, enamel, chrome, copper, zinc etc. on steel or iron, as well as all insulating coatings such as paints, plastics, enamel, etc. on non-magnetic metal substrates (e.g. aluminum, copper, brass). The switching of the combination probe for different substrates is automatic. The integrated measured value memory stores the last 10 readings.<br/>Accuracy: ± 2 microns (+ 3%), ± 0.1mil (+ 3%)</p> <table border="1"> <thead> <tr> <th>Item No</th> <th>EAN*</th> <th></th> <th>Qty</th> </tr> </thead> <tbody> <tr> <td>6150N</td> <td>020684</td> <td></td> <td>1</td> </tr> </tbody> </table>       | Item No | EAN* |  | Qty | 6150N  | 020684 |  | 1 |
| Item No   | EAN*  |         | Qty  |  |     |        |        |  |   |
| 6150N   | 020684  |         | 1    |  |     |        |        |  |   |
|    | <p><b>Thickness meter up to 5000µm</b></p> <p>Patented electronic coating thickness gauge with two independently working probes. These can measure on non-ferrous metals such as aluminum, copper, zinc both all non-magnetic coatings on steel and iron, as well as all the insulating layers. The low height of the device also allows safe measurements even at difficult to reach places. No calibration, no sensor replacement, no measuring range switching.<br/>Accuracy: ± 1 micron (+ 2%) in<br/>Range from 0.0 to 999 microns ± 3.5% within 1-5 mm</p> <table border="1"> <thead> <tr> <th>Item No</th> <th>EAN*</th> <th></th> <th>Qty</th> </tr> </thead> <tbody> <tr> <td>6151</td> <td>021766</td> <td></td> <td>1</td> </tr> </tbody> </table> | Item No | EAN* |  | Qty | 6151   | 021766 |  | 1 |
| Item No   | EAN*  |         | Qty  |  |     |        |        |  |   |
| 6151  | 021766  |         | 1    |  |     |        |        |  |   |

# Moisture meter CM-measuring

## CCM device in metal case

Complete set with all the necessary equipment to measure humidity. In metal transport box.

**Content:** Pressure bottle, pressure gauge, spring scales, pan, hammers, chisel, mortar, balls, 20 carbide vials, test vial, peen hammer, bucket, brush, check weight, replacement seals, metal carrying case.

| Item No | EAN*   | Qty |
|---------|--------|-----|
| 61300   | 750727 | 1   |



## Additional accessories

### Carbide vials

For CCM device, in container.

| Item No  | EAN*   | Content   | Qty |
|----------|--------|-----------|-----|
| 61300E/1 | 017219 | 25 vials  | 1   |
| 61300E/2 | 017226 | 100 vials | 1   |

### Test vials for manometer testing

Vials with 1 ml water, for a pressure of 1 bar, +/- 0.05 bar.

|          |        |          |   |
|----------|--------|----------|---|
| 61300E/3 | 017233 | 10 vials | 1 |
|----------|--------|----------|---|



## Material moisture meter

The material moisture meter 6075 enables rapid and non-destructive checking of the material moisture development of wood and building materials. Thus, the ideal time and place can be determined for any necessary destructive measurement. The display is in weight percentage compared to the dry mass of the material. Equipped with 10 characteristics curves for soft wood, hard wood, chipboard, anhydrite screed, cement screed, lime sand brick, aerated concrete, concrete, vertical hole brick and solid brick. Measurement depth up to 5 cm. Illuminated digital display.

| Item No | EAN*   | Qty |
|---------|--------|-----|
| 6075    | 019992 | 1   |



## Electronic moisture meter

This meter measures the moisture content of screeds and concrete floors immediately, without drilling or damaging the surface. Designed specifically for the flooring industry. Recommended by many leading flooring and adhesive manufacturers.

The Concrete Encounter CME4 shows within seconds the moisture content up to 6% for concrete and up to 4% CM (CM = calcium carbide method) for screeds, so you can decide properly about the right time for the installation of the flooring.

| Item No | EAN*   | Qty |
|---------|--------|-----|
| 61350   | 019640 | 1   |



# Moisture meter



### Hydromette Compact

Electronic moisture meter for wood and plaster in a handy format. With large 3-line LCD display. The probe tips are pressed into the respective material and enable the detection of moisture in lumber, chipboard, veneer and wood fibre materials (up to 25mm thickness) as well as normal gypsum and mixed plasters.

**Specification:**

Direct display of moisture in wood or buildings in weight-%. Measuring wood moisture: 6-25% (bd), range building moisture: 0.4 to 6.0 weight-%. Four-stage correction of wood species, characteristic curves for three types of building materials and 2 insulation materials. Min, Max and Hold function for measured values. Fully automatic calibration, no separate electrodes or cables required. Indication of the device or ambient temperature.

Weight: 160 g.

**Content:**

Incl. 9-V battery, replacement pins, protective cap in plastic box.

| Item No | EAN*    | Dimensions       | Qty |
|---------|---------|------------------|-----|
| 6015BL  | 0022107 | 195 x 50 x 30 mm | 1   |



### Hydromette Compact B

Electronic moisture indicator on the dielectric constant / high frequency measuring principle. The flexible ball probe is used to detect moisture in building materials of all kind as well as for assessment of moisture distribution in walls, ceilings and floors. Ideal pre-test for all CM devices.

**Specification:**

Direct display of building moisture in weight% and in CM% over the 3-line LCD Measuring range building moisture: 0-100 digits scanning range; 0.3 to 6.0 weight%; 0.3 to 4.0% CM curves for 7 types of building materials and insulation materials 2 and tendency indicator for hard and soft wood.

Indication of the device or ambient temperature. Weight: 170 g.

**Content:**

Incl. 9-V battery in plastic box.

| Item No | EAN*    | Dimensions       | Qty |
|---------|---------|------------------|-----|
| 6016BL  | 0022114 | 200 x 50 x 30 mm | 1   |

**Material moisture**

Measuring range: 0...90 %  
Resolution: 0.1  
Accuracy: ±1 % (conductivity)

**Humidity**

Measuring range: 0...100 %rF  
Resolution: 0.1 %rF  
Accuracy : ±2.5 %rF (5...95 %rF)  
Units: %rF, wet bulb, dew point

**Air temperature**

Measuring range: -10...+50 °C  
Resolution: 0,1 °C  
Accuracy: ±0,5 °C  
Units: °C/°F  
Operating temp.: -10...+50 °C  
Battery Type: Alkaline (2x AAA)  
Operating time: 130 hrs.  
(typ. without display illumination)  
Dimensions: 119 x 46 x 25 mm



### Pocket Line measuring device Pajarito 6074

Pajarito 6074 measures material moisture. Using stored material characteristic curves for wood and building material moisture is directly displayed in percent by weight.

Additionally, the humidity and temperature is measured. So, for example, drying conditions can be reliably assessed directly on site. Precise measurement of material moisture measurement with stored characteristic curves for cement screed, concrete, plaster, anhydrite screed, cement mortar, lime mortar, brick. Hold function for easy readout of measurement values.

Display lighting.

Measurement of temperature and humidity of the ambient air incl. dewpoint.

| Item No | EAN*   | Dimensions | Qty |
|---------|--------|------------|-----|
| 6074    | 018421 |            | 1   |



Please note: image scale of products may vary.

# Moisture meter

| <b>Digital thermo-hygrometer GFTH 95</b>                        |             |            |
|---|-------------|------------|
| Enables humidity and temperature measurement in seconds.        |             |            |
| <b>Specification:</b>   |             |            |
| Temperature measuring range -20 to 70°C.<br>Humidity 0 to 100%. |             |            |
| <b>Item No</b>  | <b>EAN*</b> | <b>Qty</b> |
| 61320   | 750734      | 1          |



| <b>CAISSON indicator VI-D1</b>   |             |            |
|--|-------------|------------|
| For quick testing of concrete and wood. The unit provides information on moisture up to 3 cm depth. Non-destructive inspection method. Handy carrying bag. |             |            |
| <b>Content:</b>  |             |            |
| Incl. carrying bag and 9-V battery.  |             |            |
| <b>Item No</b>   | <b>EAN*</b> | <b>Qty</b> |
| 61330  | 750697      | 1          |



| <b>Thermo hygrometer TH100</b>  |             |            |
|---|-------------|------------|
| Allows measurements in about 20 minutes of ground temperature, relative humidity, saturation humidity in g / m <sup>3</sup> , wood moisture depending on the relative humidity. Ideal for laying parquet. |             |            |
| <b>Item No</b>  | <b>EAN*</b> | <b>Qty</b> |
| 61340   | 552383      | 1          |



# Hydromette RTU 600, Set



| Hydromette RTU 600, Set   |        |                   |     |
|---|--------|-------------------|-----|
| Electronic four-in-one meter for wood and building materials, air humidity and temperature. Complete set with available accessories stated below.   |        |                   |     |
| <b>Specification:</b>   |        |                   |     |
| Handy moisture and temperature meter for fast single and series measurements. Direct reading on large LCD display, reading accuracy 0.1 digit, fully automatic analyser calibration. Highest accuracy for each type of wood by specifying a variety-specific calibration curves-code, automatic temperature compensation (-10 to + 90 ° C). Weight 390 g (without accessories), powered by 9V battery or Ni-Cd rechargeable battery (optional). |        |                   |     |
| Item No   | EAN*   | Dimensions        | Qty |
| 6018  | 002260 | 180 x 115 x 53 mm | 1   |
| Included accessories  |        |                   |     |
| <b>Drive-in electrode M 20</b>  |        |                   |     |
| For depth measurements up to 70 mm in soft, set building materials (plaster, gypsum, etc.) and timber up to 50 mm thickness. The electrode body is made of durable plastic. 10 replacement nibs, 16 and 23 mm.  |        |                   |     |
| 6019  | 002277 |                   | 1   |
| <b>Active electrode RF-T 28 EL</b>  |        |                   |     |
| 6017.4  | 005162 |                   | 1   |
| <b>Stick-in electrodes pair M 6</b>   |        |                   |     |
| 6020  | 002284 |                   | 1   |
| <b>Contact paste</b>  |        |                   |     |
| 6023  | 002314 |                   | 1   |
| <b>Measuring cable MK 8</b>   |        |                   |     |
| 6017.5  | 006152 |                   | 1   |
| <b>Carrying case IV</b>   |        |                   |     |
| 6017.6  | 005186 |                   | 1   |



| Available accessories  |        |          |   |
|--|--------|----------|---|
| <b>Active electrode MB 35</b>  |        |          |   |
| With integrated electronics for the detection of surface moisture in concrete, especially before applying coatings or adhesives. Penetration depth approximately 2 to 5 mm. Measuring range: 2-8% by weight/oven dry method. |        |          |   |
| 6021   | 002291 |          | 1 |
| <b>Active electrode IR 40 EL</b>   |        |          |   |
| For fast detection of surface temperature with an infrared sensor. Measuring range -20 to + 199.9° C.  |        |          |   |
| 6022   | 002307 |          | 1 |
| <b>Active electrode B 60</b>   |        |          |   |
| For the detection of moisture in building materials of all kinds. Nondestructive measurement using concentrated radio frequency field.   |        |          |   |
| Range 1: 0 to 199 digits,<br>Range 2: 0.3 to 8.5 weight% and 0.3 to 6.5% CM  |        |          |   |
| 6024   | 002321 |          | 1 |
| <b>Electrode pins 16 mm</b>  |        |          |   |
| For M 6 and M 20, no insulation, max. penetration 10 mm.   |        |          |   |
| 6025   | 002338 | 100 pcs. | 1 |
| <b>Electrode pins 23 mm</b>  |        |          |   |
| For M 6 and M 20, no insulation, max. penetration 17 mm.   |        |          |   |
| 6026   | 002345 | 100 pcs. | 1 |



Please note: image scale of products may vary.

# Hydromette Uni 2, Set

| Hydromette Uni 2, Set   |        |                     |     |
|---|--------|---------------------|-----|
| <p>Digital meter with additional resistance measurement system for construction materials. Complete set with available accessories stated below.</p> <p><b>Specification:</b><br/>                     Direct reading on large LCD display, reading accuracy 0.1 digit, weight 230 g (without accessories), powered by 9V battery or Ni-Cd rechargeable battery (optional).</p> |        |                     |     |
| Item No   | EAN*   | Dimensions          | Qty |
| 6017  | 002253 | 140 x 90 x 42/50 mm | 1   |
| Included accessories  |        |                     |     |
| <p><b>Active electrode B 60</b><br/>                     For the detection of moisture in building materials of all kinds. Non-destructive measurement using concentrated radio frequency field. Range 1: 0 to 199 digits. Range 2: 0.3 to 8.5 weight% and 0.3 to 6.5% CM.</p>  |        |                     |     |
| Item No   | EAN*   |                     | Qty |
| 6024  | 002321 |                     | 1   |
| <p><b>Active electrode RF-T 28 EL</b><br/>                     For the instant measurement of relative humidity and air temperature. Measurement range: humidity 7 to 98%, air temperature -10 to +80° C.</p>   |        |                     |     |
| 6017.4  | 005162 |                     | 1   |
| <p><b>Active electrode IR 40 EL</b><br/>                     For fast detection of surface temperature with an infrared sensor. Measuring range -20 to +199.9° C.</p>   |        |                     |     |
| 6022  | 002307 |                     | 1   |
| <p><b>Stick-in electrodes pair M 6</b><br/>                     For the measurement of hard, set building materials (concrete, screeds, etc.). With two spare pins each 23, 40 and 60 mm length (only in conjunction with contact paste).</p>   |        |                     |     |
| 6020  | 002284 |                     | 1   |
| <p><b>Contact paste</b><br/>                     For measuring hard materials such as concrete and screeds in conjunction with electrodes M 6 and M 20.</p>   |        |                     |     |
| 6023  | 002314 |                     | 1   |
| <p><b>Measuring cable MK 8</b><br/>                     Suitable for all devices and electrodes, 1 m length. For the detection of moisture in building materials of all kinds. Non-destructive measurement using concentrated radio frequency field. Measuring range: 0 to 199 digits.</p>  |        |                     |     |
| 6017.5  | 005179 |                     | 1   |
| <p><b>Carrying case IV</b><br/>                     For storage of the complete set.</p>  |        |                     |     |
| 6017.6  | 006152 |                     | 1   |
| <p><b>Electrode pins 16 mm</b><br/>                     For M 6 and M 20, no insulation, max. penetration 10 mm.</p>  |        |                     |     |
| 6025  | 002338 | 100 pcs.            | 10  |
| <p><b>Electrode pins 23 mm</b><br/>                     For M 6 and M 20, no insulation, max. penetration 17 mm.</p>  |        |                     |     |
| 6026  | 002345 | 100 pcs.            | 10  |



# Laser technology



### Rotating laser EL 515 Set

Instant self-levelling Horizontal self-levelling rotating laser; vertical levelling with one footscrew Automatic shut-off and audible alarm when out of self-levelling range Variable rotating speed Permanent 90° beam to zenith Rechargeable NiMH batteries with intelligent charger Integrated floor/wall mount with adjustment screw

#### TECHNICAL DATA EL 515 Plus

Self-levelling range:  $\pm 3^\circ$   
 Accuracy:  $\pm 1,5 \text{ mm} / 10 \text{ m}$   
 Working range without receiver  $\varnothing: 30 \text{ m}^*$   
 Working range with receiver  $\varnothing: 400 \text{ m}$   
 Rotating speed (rpm): 200, 400, 600  
 Power supply: NiMH  
 Operating time: 20 h  
 Dust/water protection: IP 54  
 Laser diode / class: 635 nm / 2  
 Temperature range:  $-10^\circ\text{C}$  to  $+45^\circ\text{C}$   
 Weight (instrument with battery): 1,5 kg

#### TECHNICAL DATA Receiver EL 702

Indication: 2 x LCD  
 2-step accuracy  $\pm 2 \text{ mm}, \pm 1 \text{ mm}$   
 Display illumination: yes  
 Power supply: 1 x 9V

#### SUPPLIED WITH

Rotating laser EL 515 Plus  
 Receiver EL 702 with clamp for levelling staff  
 NiMH batteries & intelligent charger  
 Height adjustable wallmount with adjustable range of 21 cm  
 Lightweight elevating tripod, working range 0,55 - 1,58 m  
 Telescopic levelling staff, 5 section, working range 0,67 - 2,45 m  
 Magnetic target, Laser intensive glasses, Hard case

| Item No | EAN*   | Qty |
|---------|--------|-----|
| 6039HP  | 029014 | 1   |



### Receiver

Height indication by large display and a 3-way LED: front, sides and top. With built-in spirit levels, and retainer clip. Switchable tone and automatic shutdown. Matching the line lasers 6034HP, 6037HP, 6038HP and 6044HP.

| Item No | EAN*   | Qty |
|---------|--------|-----|
| 6035    | 029380 | 1   |



### Line laser

Self-levelling line laser with 360° - horizontal line and 4 laser points at right angles to each other. Shutdown of self-levelling function for manual use. Visual and audible alarm if out of level.

#### Specification:

- Self-levelling range  $\pm 5^\circ$
- Accuracy  $\pm 3 \text{ mm} / 10 \text{ m}$
- Working range without receiver 20 m
- Working range with receiver 60 m
- Operating time 8 h
- Power supply 4 x AA Alkaline
- Laser Diode 635nm
- Laser class 2
- Dust / water protection IP 53
- Temperature range  $-10^\circ \text{C}$  to  $+40^\circ \text{C}$

#### Content:

- Wall / tripod mount
- Magnetic target plate
- Laser Glasses
- Mounting strap
- Batteries
- Padded bag

| Item No | EAN*   | Qty |
|---------|--------|-----|
| 6044HP  | 029021 | 1   |

**Line laser FI 40-Pocket II HP**

Robust and handy, self-leveling cross line laser. Visual and audible alarm if out of level. Transport safe.

**Specification:**

- Self-leveling  $\pm 4^\circ$
- Accuracy  $\pm 3 \text{ mm} / 10 \text{ m}$
- Working range without receiver 20 m
- Working range with receiver 60 m
- Operating time 48 h
- Power supply 3 x AA Alkaline
- Laser diodes / Laser class 635 nm / 2
- Dust / water protection IP 54
- Weight 0.8 kg

**Content:**

- Magnetic Wall / tripod mount
- Batteries
- Magnetic target plate
- Laser glasses
- Bag

| Item No | EAN*   | Qty |
|---------|--------|-----|
| 6037HP  | 029038 | 1   |

**Line laser FL 40-3 Liner HP**

The ideal laser measuring tool for interior design. 3 clearly visible laser lines. Visual and audible alarm if out of level. Transport safe.

**Specification:**

- Self-leveling  $\pm 3.5^\circ$
- Accuracy  $\pm 3 \text{ mm} / 10 \text{ m}$
- Working range without receiver 20 m
- Working range with receiver 60 m
- Operating time 15 h
- Power supply 3 x AA Alkaline
- Laser diodes / Laser class 635 nm / 2
- Dust / water protection IP 53
- Weight 0.86 kg

**Content:**

- Wall / tripod mount
- Batteries
- Magnetic target plate
- Padded case

| Item No | EAN*   | Qty |
|---------|--------|-----|
| 6034HP  | 022275 | 1   |

**Line laser FL-40 4 Liner**

The entry-level unit of the professional class. A horizontal and vertical three laser lines. Switched self-leveling function, so that the laser beam may be used manually (tilted). Wall / tripod mount (magnetically attached) with centring for perfect alignment over a ground point. Visual and audible alarm if out of level. Transport safe.

**Specification:**

- Self-leveling  $\pm 3.5^\circ$
- Accuracy  $\pm 3 \text{ mm} / 10 \text{ m}$
- Working range without receiver 20 m
- Working range with receiver 60 m
- Operating time 12 h
- Power supply 3 x AA Alkaline
- Laser diodes / Laser class 635 nm / 2
- Dust / water protection IP 53
- Weight 1.0 kg

**Content:**

- Wall / tripod mount
- Batteries
- Magnetic target plate
- Laser glasses
- Padded case

| Item No | EAN*   | Qty |
|---------|--------|-----|
| 6038HP  | 029045 | 1   |



# Precision measuring



| EcoDist Pro   |        |     |
|---|--------|-----|
| The new EcoDist Pro is the successor to the highly successful EcoDist Plus. The new and improved version has an extended range of up to 50 meters. EcoDist Pro is an easy to use entry-level tool with professional expectations. |        |     |
| Item No   | EAN*   | Qty |
| 6030  | 029359 | 1   |

| Specification     |  |
|-------------------|--|
| Distance:         | 0.10 to 40 m   |
| With target       | 50 m   |
| Accuracy:         | 2 mm +/-   |
| Protection class: | IP 40  |
| Features:         | Plus, Minus, length, area, volume, indirect height measurement, continuous measurement, reference switching front/rear |
| Measuring units:  | mm, ft, in   |
| Dimensions:       | 118 x 50 x 26 mm   |
| Weight:           | 110g with batteries  |



| GeoDist Pro  |        |     |
|--|--------|-----|
| The new professional laser rangefinder for precise measurement of lengths, areas, volumes and more. Rock solid and professional features in an attractive look and feel. |        |     |
| Item No  | EAN*   | Qty |
| 6031   | 029366 | 1   |

| Specification     |  |
|-------------------|--|
| Distance:         | 0.10 to 80 m   |
| With target       | 100 m  |
| Accuracy:         | 1 mm +/-   |
| Protection class: | IP 54  |
| Features:         | Plus, Minus, length, area, volume, indirect height measurement, continuous measurement, reference switching front/rear |
| Dimensions:       | 120 x 58 x 29 mm   |
| Weight:           | 146g with batteries  |

We carry the complete Leica range!  
Our sales team is there to advise you.  
Catalogue orders phone +49 2104 / 30000



Please note: image scale of products may vary.

# Accessories

## Floor-to-ceiling pillar KS3

Practical monopod clamp pillar. Can be clamped between floor and ceiling and consists of 5 sections. Max. Height 3600 mm. Incl. Adapter for 5/8" and 1/4". Supplied with carrying bag.

| Item No | EAN*   | Qty |
|---------|--------|-----|
| 6036    | 002116 | 1   |



## Elevating tripod FS 14

Tripod with proven quick-clamp, affixed, lockable crank mechanism, adjustment range 320 mm, continuously tiltable slide to 90°. The total working range is 60 to 1820 mm incl. Extended centre column. Integrated, retractable rubber pads for smooth surfaces. Complete with convenient carrying bag. Weight 1.9 kg.

| Item No | EAN*   | Work-range  | Qty |
|---------|--------|-------------|-----|
| 6040    | 004875 | 57 - 161 cm | 1   |



## Aluminium elevating tripod FS12

Tripod with proven quick-clamp, shoulder strap, sturdy links between the tripod legs firmly mounted crank, with an adjustment range of 40 cm, lockable rotatable crankshaft and fixable tripod plate with 127 mm Ø, mm scale on centre column.

The total working range is 90 to 2850 mm incl. extended centre column. Integrated, retractable rubber pads for smooth surfaces. Weight 8.2 kg.

| Item No | EAN*   | Work-range  | Qty |
|---------|--------|-------------|-----|
| 6041    | 004899 | 73 - 244 cm | 1   |



## Laserpoint glasses GLB10

Red-lens glasses for better visibility of the laser dot in bright rooms and outdoors. Range approximately 15 m.

| Item No | EAN*   | Qty |
|---------|--------|-----|
| 6043    | 004882 | 1   |



# Terms of Delivery and Payment

## § 1 – Validity

1. Our conditions shall only apply for businesspersons in the sense of § 310 of the German Civil Code (BGB).  
2. The following terms and conditions of sale and delivery shall apply to all our contracts, deliveries and other performances insofar as they have not been modified or excluded with our express written consent. They shall also particularly apply when we carry out the delivery/performance unreservedly, although being aware of our customer having other conditions. The general terms and conditions of our customers shall only apply when we confirm them in writing.  
3. Our conditions shall also apply to all future contracts, deliveries and performances even though they are not sent again in text form to our contractual partner with our offer or our order confirmation.

## § 2 – Offer and closing

1. Our offers are without engagement. Contracts and other agreements shall only become binding with our written confirmation or with our delivery/performance.  
2. All agreements between us and our customers shall need to be in writing when the contract is closed. Agreements between our staff or representatives and our contractual partner on closing or after the closing shall require our written confirmation to be effective; the power of attorney of our staff and representatives is insofar limited.  
3. Official confirmation letters from our contractual partner shall not mean that a contract with a different content to our offer, our order confirmation or any other of our written declarations comes into being, even although we do not object to them.  
4. Insofar as the written form is stipulated in the conditions on hand, it shall be deemed as observed when corresponding declarations are transmitted by fax or email. A written agreement shall also be deemed as having materialised when we and our contractual partner each provide declarations with identical content in writing.

## § 3 – Prices, price increases and payment

1. Unless agreed to the contrary, our prices are stated in euro and our contractual partner shall effect payment in euro. All prices quoted are net prices. The statutory level of VAT shall be added to the amount. Our prices are quoted ex works including packaging for the domestic market, but without freight charges, tax, insurance, transportation, letters of credit or other documents necessary for the fulfilment of the contract unless agreed to the contrary. Orders below € 50.00 net (foreign: €100.00 net) shall be subject to a minimum quantity surcharge of €15.00 net. Orders above €350.00 net shall be effected free domicile within the Federal Republic of Germany; foreign orders above €1,000.00 shall be delivered free German border or German sea port or airport (including packing).  
2. Should, on orders that are to be executed later than six weeks after closing, our purchase prices and/or the wage or salary tariffs applicable for us increase between closing the contract and execution of the order, we shall be entitled to demand a correspondingly pro rata higher price to the one agreed to reflect the proportional percentage increase in the purchase price and/or the wage costs.  
3. We reserve the right to only supply *pari passu* against payment of the agreed price. Furthermore, unless agreed to the contrary or stated otherwise in our offer or our order confirmation, our invoices are to be paid within 8 days of invoice date with 2 % discount or within 30 days of invoice date without any deductions (in the case of deliveries abroad: immediately upon receipt of the goods with 2 % discount or within 30 days of invoice date without any deductions). Invoice amounts below €100.00 net are anyway to be paid within 30 days of invoice date without any deductions. We shall only accept cheques or bills of exchange as conditional payments; they may be returned at any time. They shall only be deemed as payment when they have been honoured and irrevocably credited to our account. All costs and expenses incurred in connection with cheques and negotiating bills of exchange shall be borne by our customer. Should our customer be in arrears with any kind of payment obligation towards us, irrespective of the type, all existing claims against our customer shall for due for immediate payment.  
4. Payments are to be rendered in euro at all times

unless another currency has been expressly agreed.  
5. We shall be entitled to interest in an amount of eight percentage points above the respective base interest rate from maturity without the need for any further reminders. More far reaching claims particularly arising from a default on the part of our contractual partner shall remain unaffected by this.

## § 4 – Place of fulfilment

The place of fulfilment for deliveries, performances and payments shall always be Mettmann.

## § 5 – Offsetting, retention

Offsetting with counter-claims that we contest or have not been legally established shall be impermissible. The assertion of a right of retention resulting from claims that do not ensue from the same contractual relationship shall be excluded unless we have acknowledged such claims or such have been legally established.

## § 6 – Deterioration in the financial situation, payment default of our contractual partner

1. Should one of the below-mentioned events occur or should we become aware of such an event – that already prevailed at the closing of contract – after the closing of the contract, we can demand advance payment from our contractual partner for the amount of the agreed price and moreover revoke the agreed or granted credit periods, return pending bills of exchange and insist upon immediate payment. This shall apply to the following events:  
- Our contractual partner files for the opening of court or out-of-court insolvency or settlement proceedings or court or out-of-court insolvency or settlement proceedings are opened against the assets of our contractual partner or the opening of such proceedings is rejected on account of a lack of assets.  
- A written credit report from a bank or credit agency is at hand from which the credit unworthiness of our contractual partner or a considerable deterioration in same's financial circumstances can be derived or a cheque or bill of exchange that we have accepted from our contractual partner is not honoured or is subject to protest.  
- Our contractual partner is in default with payment within the scope of another business transaction.  
2. Should our contractual partner not satisfy our justified demands for advance payment within a reasonable period of grace set by us, even though we have informed same that upon expiry of the deadline we shall reject the acceptance of any further performance on same's part, we shall be entitled to withdraw from the contract or to insist on compensation instead of the performance, but this only in respect of that part of the contract that we have not as of then fulfilled.

## § 7 – Despatch and transfer of risk, insurance, disposal

1. The risk shall automatically transfer to our customer with the despatch of the goods – irrespective of the location of shipment – and this even in cases where freight paid delivery or free buyer's warehouse have been agreed.  
2. Should there be any missing despatch instructions from our contractual partner or should a modification to such seem necessary, we shall despatch to the best of our knowledge without any obligation as to it being the cheapest or fastest shipping option. It is only at the request of our contractual partner and at same's expense that we shall insure the delivery items against any insurable risks desired by our contractual partner, in particular against theft and transportation damage. Any cases of transportation damage shall be reported to us immediately. Moreover, upon delivery, the recipient shall ensure that the corresponding claims and misgivings are reported to the carrier.  
3. Should the despatch be delayed at the request of our contractual partner or for reasons for which the contractual partner is responsible, the goods shall be stored at the cost and risk of our contractual partner.  
4. Insofar as we are obliged to take back packaging, our contractual partner shall bear the costs for the return transportation of the packaging used.  
5. Our customer undertakes to properly dispose of the goods supplied at own expense and in line with legal requirements upon discontinuance of use. Same shall exempt us from any take-back obligation as ma-

nufacturer and from all other obligations associated with this.

## § 8 – Delivery periods, call orders, delay, impossibility of delivery

1. Delivery periods and dates shall only be deemed as binding when we have confirmed them in writing.  
2. A deadline period determined solely by its length shall begin with the expiry of that day on which agreement is found on all the details of the content of the order, at the earliest with our acceptance of the order, but not before all the documents, approvals and clearances to be obtained by orderer have been furnished and not before receipt of a down-payment that may need to be rendered by orderer. Agreed deadlines and dates as well as a delivery date/delivery period valid without any such agreement shall be correspondingly put back in the case of any delay in the creation of the above-mentioned preconditions. Our contractual partner shall bear the onus of proof that the necessary preconditions were satisfied and that the required documents, plans and information had been made available.  
3. Delays in delivery as a consequence of acts of God, war, riots, strikes, lockouts, machine breakdowns, material shortages or similar circumstances beyond our control shall release us from delivery obligations entered into for the period of the disruption and entitle us to withdraw from the contract at our own discretion, but without the orderer being entitled to withdraw; any claims of orderer on account of delayed delivery, irrespective of the reason, shall be excluded. Insofar as delays for the above-mentioned reasons last for more than three months, our contractual partner shall be entitled to withdraw from the contract – to the exclusion of any further claims – after setting another extension period of time for performance of at least four weeks. The right to withdrawal shall be limited to that part of the contract that has not as of then been fulfilled unless our contractual partner no longer has any interest in the fulfilled part of the contract.  
4. Our performance shall be deemed as rendered when the goods – as per contract – are ready for despatch in our works and this readiness has been communicated to the orderer; moreover, when they leave our works in accordance with the contract. Should the delivery be delayed for reasons the orderer is responsible for, the delivery period shall be deemed as observed with the notification of readiness for despatch.  
Agreed deadlines and dates as well as a delivery date/delivery period valid without any such agreement shall be extended or put back by that period in which our contractual partner is in default with its obligations from the current business relationship or even from other contracts.  
5. Partial deliveries shall be permissible for us insofar as they can be deemed reasonable for our contractual partner. The contractual partner may not insist on such unless something to the contrary has been expressly agreed.  
6. Should we be in delay with our delivery or if our performance obligation pursuant to § 275 BGB is excluded, we shall only be liable for damages under the circumstances and to the extent described in § 11, however with the following additional stipulations:  
- Should we be in delay with our delivery and it is merely a case of slight negligence on our part, the claims of our contractual partner to compensation shall be limited to a lump-sum delay compensation amount of 0.2 % of the delivery value for each completed week of the delay, however maximum 5 % of the delivery value, whereby we reserve the right to prove that no or only a lower degree of damage was incurred as a consequence of the delay in delivery.  
Any claims of our contractual partner going beyond this shall only exist when the performance failure can be attributed to intent or gross negligence on our part.  
- In the event of our delay, our contractual partner shall only be entitled to compensation instead of performance when same has previously set us a reasonable, at least 4-week extension period for delivery, whereby same may grant us a reasonable deadline of less than four weeks insofar as in some individual cases an extension period of at least four weeks is unreasonable for our contractual partner.  
- Any right of our contractual partner to withdraw from the contract and any claims of our contractual partner

to compensation shall be fundamentally limited to the not yet performed part of the contract unless our contractual partner, reasonably-enough, no longer has any interest in the fulfilled part of the contract.

- Claims for compensation made against us for delays in delivery or for exclusion of the performance obligation pursuant to § 275 BGB shall lapse after one year from the start of the statutory limitation period.

- The above-mentioned provisions shall not apply when it is a case of compensation for injury to the life, body or health of our contractual partner or the damage is attributable to an intentional or grossly negligent breach of duty on our part, by one of our legal representatives or agents; moreover, not in the case of a delay in delivery when a transaction has been agreed where time is of the essence.

7. Orders on call shall only be taken on with acceptance periods. Should the acceptance period not be exactly defined, it shall expire 12 months after the closing of the contract. In this context, the goods are to be called up in approximately equal monthly quantities. Should acceptance not be concluded within the agreed time period, we shall be entitled to supply the completed deliveries without any further notification or to store them at acceptor's expense. Further, we shall be entitled to set our customer an extension period for acceptance, associated with the threat that we shall reject the acceptance of the goods in the event of the futile expiry of this period. Should the extension period then expire fruitlessly, we shall be entitled to withdraw either wholly or partially from the contract after terminating our delivery obligation or after rejecting the delivery to demand compensation for non-fulfilment.

### § 9 – Complaints

1. Our contractual partner shall need to notify us immediately of any complaints. In these cases payments may only be withheld when there is no doubt as to the justification of the complaint. The extent of such will need to be in a reasonable relationship to the material defects. Should the complaint be unfounded, we can demand compensation from the contractual partner for the work effort and costs incurred.

2. In the case of justified complaints within the warranty period of one year, we shall at our discretion rework the parts, supply a replacement delivery or render the performance anew.

### § 10 – Nature of the goods, excess or shortfall performances

1. Our information and technical descriptions on the subject matter of performance and the application, on dimensions, weights, use or on any other features contained either in leaflets, price lists, descriptions, illustrations, drawings, sketches, directories or other data files shall merely constitute approximate values customary in the trade. They only serve the purpose of describing our products and shall only become binding when we expressly confirm them or they are otherwise agreed with our contractual partner. The same shall apply accordingly to our specimens and samples that are only meant as approximate visual indications of quality, dimensions and other features.

2. In the case of a technically-caused necessity, we reserve the right to supply the goods ordered in another quality, in different dimensions and with other features insofar as the supplied items are not impaired by this in their usability and the deviations are not unreasonable for our contractual partner for other reasons.

3. Should orders be placed for special tools (tools which are not listed in our catalogue with particular design or a specific model such as e.g. with a special colour or printing), then the delivery may fall below or exceed that ordered by a reasonable number, in particular insofar as such is production-related or customary in the trade. The invoice shall always reflect the number of parts actually delivered.

### § 11 – Defects and liability

1. To enable inspections and the establishment of claims due to shortcomings in an item or a work, the contractual partner shall if requested make available in a timely fashion an adequate quantity of what same feels are defective parts to allow for verification either by ourselves or by a third party, whereby we shall bear the costs of the despatch.

2. The rights of our contractual partner arising from defects in a supplied item or rendered performance shall be determined in accordance with the legal regulations, but with the stipulation that we shall be granted an appropriate period for supplementary performance of at least four weeks, whereby our contractual partner shall reserve the right to set us a shorter deadline in specific cases insofar as an at least four-

week period is unreasonable for same.

Compensation for our contractual partner arising from defects in the delivery or performance shall be limited to the extent described below under clause 3.

3. Our liability for damage resulting from an injury to the life, body or health of our contractual partner due to a culpable breach of duty shall be neither excluded nor limited.

We shall only be liable for other damage to our contractual partner when such is caused by a wilful or grossly negligent breach of duty by us, one of our legal representatives or agents. Apart from that, any claims for compensation by our contractual partner for breach of duty, shortcomings, unauthorised actions or any other legal reason shall be excluded.

The above-mentioned limitations of liability shall not apply to a lack of properties and characteristic features if and insofar as the agreement had the purpose of protecting our contractual partner against damage not ensuing from the goods supplied or the performance itself.

Insofar as our liability is excluded or limited, the same shall also apply to the personal liability of our employees, workers, staff and agents.

The above-mentioned exclusion of liability shall apply in any case, also for consequential damage.

The above-mentioned exclusion of liability shall not however apply to claims arising from the German Product Liability Act.

4. The warranty period shall run for one year from the point in time of the transfer of risk in the case of purchase contracts and contracts governing the supply of work and materials. In the case of contracts for work, the warranty period shall run for one year from the point in time of acceptance, irrespective of whether this is done formally or implicitly.

### § 12 – Reservation of title

1. The goods supplied shall remain in our ownership until all claims against our contractual partner, either present or future, have been satisfied.

Processing or transformations of the goods we supply is on our behalf as manufacturer, but without any obligation on our part. Should the goods we supply be processed with other objects not belonging to us, we shall acquire co-ownership of the new item in the proportion of the invoice value of the goods we supplied to the invoice value of the other goods used at the point in time of processing. If our goods are connected with other moveable objects to form a unitary item and if the other item is to be regarded as the main item, our contractual partner shall assign to us proportional co-ownership insofar as the main item belongs to the contractual partner. Any required transfer for us to acquire ownership or co-ownership shall be deemed as replaced by the agreement thus made that our customer shall keep the item for us like a borrower or insofar as same does not possess the item, to hereby replace such transfer by assigning to us the right to recover possession from the owner.

Goods or items that we supply which we have (co-) ownership of pursuant to the above provision shall be referred to in the following as "goods subject to reservation".

2. Our contractual partner shall be entitled to sell the goods subject to reservation in the ordinary course of business or to connect such with items of others. The claims resulting from the sale, connection or any other legal foundation regarding the goods subject to reservation shall hereby be assigned to us by our contractual partner either wholly or proportionately to that extent to which we are entitled to co-ownership of the sold of processed object. When allocating such accounts receivable to current invoices, this assignment shall apply to all outstanding balances. The assignment shall have priority over all other claims.

We authorise our contractual partners subject to revocation to collect the assigned claims. Our contractual partner shall immediately pay the collected amounts to us insofar and as soon as our receivables fall due. Insofar as our claims are not as of then due, the collected amounts shall be booked separately by our contractual partner.

Our authorisation for self-collection of the receivables shall remain unaffected. However, we undertake not to collect the receivables as long as our contractual partner meets its payment obligations from the proceeds collected, does not get into arrears with payments and, in particular, no application to open insolvency proceedings has been filed or a suspension of payments occurs. Should this be the case, however, our contractual partner shall be obliged to inform us of the assigned claims and name their debtors, to hand us over the accompanying documentation and to provide

us with all the necessary details to enable collection as well as to notify the third-party debtor of the assignment, whereby we shall be entitled to notify the third-party debtor ourselves of the assignment. The rights of our contractual partner to resell, process, mix or mount the goods subject to reservation shall lapse without any revocation from our side with the suspension of payments or the filing for the opening of insolvency proceedings as shall the authorisation to collect assigned claims.

3. Our contractual partner shall notify us immediately of any seizure of the goods subject to reservation and of any attachment to the assigned claims by third parties and to bear the costs that may ensue for interventions or the rebuffing of such.

4. Our contractual partner shall be obliged to treat the goods subject to reservation carefully, in particular to insure them at sufficient reinstatement value at own expense against damage from fire, water and theft.

5. In the case of conduct by the contractual partner that is contrary to the contract, in particular payment defaults, we shall be entitled to repossess the goods subject to reservation at the contractual partner's expense or to insist upon assignment of its rights to recover possession against third parties. Our repossession or seizure of the goods subject to reservation shall not constitute a withdrawal from the contract unless we state this expressly in writing.

6. Should our reservation of title lose its validity with deliveries abroad or for any other reason or should we for any kind of reason lose ownership of the goods subject to reservation, our contractual partner shall be obliged to furnish us immediately with another security for the goods subject to reservation or another security for our claims; a security which according to the law applying in the country of our contractual partner is effective and comes as close as possible to the reservation of title provision pursuant to German law.

7. Should the nominal value of the security permanently exceed our claims by more than 20 %, we would then – at the request of the contractual partner – release at our own discretion a corresponding proportion of the security.

### § 13 – Property rights

1. Should the goods be manufactured in accordance with drawings, samples or other details from the contractual partner, the contractual partner shall be responsible that no kinds of rights of third parties, in particular patents, utility models and other protected rights and copyrights are infringed. The orderer shall exclude us from any claims of third parties that result from a possible infringement of such rights. Moreover, our contractual partner shall assume all costs which we incur as a result of third parties asserting the infringement of such rights and of our defence against such.

2. Should – in the course of our development work – results, solutions or technologies emerge which may be eligible for some kind of protection, we alone shall be the proprietor of the copyrights and the rights of ownership and use resulting from this. We reserve the right to register the corresponding property rights on our own behalf and in our own name.

### § 14 – Venue, applicable law

1. The exclusive venue for cheque and bill of exchange proceedings as well as for all disputes ensuing between the parties shall be Mettmann. However, in this respect we shall have the right to sue our contractual partner at any other court having jurisdiction pursuant to § 12 ff. of the German Code of Civil Procedure (ZPO).

2. The business relationship between us and our contractual partner shall be exclusively governed by the law applicable in the Federal Republic of Germany to the exclusion of international commercial law, in particular UN sales conventions and any other international agreements aimed at unifying commercial law.

Mettmann, February 2013

As of: 1 Dez. 2014

Managing Directors:  
Dirk Willing  
Reinhold Linke

Commercial Register No.:

18750

Court of Registration:

Wuppertal

# A

**Name..... page**

Abrasive paper ..... 165  
 Abrasive paper discs ..... 165ff  
 Active electrodes ..... 174ff  
 Adjustable hacksaw ..... 62  
 Accumulator LED ..... 157  
 Aluminium shaft ..... 33, 36  
 Angle plane..... 37  
 Apprentice tool box ..... 94  
 Auger-reamer ..... 112

# B

**Name..... page**

Barrier tape ..... 149  
 Basket-mixer ..... 108  
 Beryllium stripping knife ..... 9  
 Board carriers ..... 113  
 Bodywork spatula ..... 15  
 Bolt cutter ..... 114  
 Brass scraper ..... 9  
 Brass wire brush ..... 88  
 Broom stick ..... 150  
 Brooms ..... 150  
 Brush holder ..... 79, 85  
 Brush pot ..... 80ff  
 Brushes ..... 88  
 Bucket cart ..... 143  
 Bucket grid ..... 79

# C

**Name..... page**

Carbide-tipped scorer ..... 149  
 Carborundum file ..... 135  
 Carpenter's hammer ..... 146  
 Carpenter's pencils ..... 140  
 Carpet awl ..... 141  
 Carpet clamp ..... 139  
 Carpet cutter ..... 130ff  
 Carpet cutter Tapicut ..... 130  
 Carpet glider ..... 139  
 Carpet ring pins ..... 142  
 Carpet scissors ..... 59  
 Carpet seam roller ..... 138  
 Carpet stretcher shaft ..... 130  
 CCM device ..... 171  
 Centring device ..... 115  
 Chalk ..... 78  
 Chalk lines ..... 78  
 Chamfer King ..... 137  
 Chisel scraper ..... 10  
 Chisels ..... 147  
 Clamps ..... 85  
 Clean and Go ..... 81  
 Cleaning brush ..... 167  
 Cleaning fleece ..... 117  
 Cleaning set ..... 89  
 Cleaning tube ..... 82

Coloquick ..... 42  
 Concave blades ..... 51  
 Construction site key ..... 148ff  
 Cork grip spreader ..... 20  
 Cork grip spreader ..... 21  
 Corner roller ..... 101  
 Corner trowel ..... 23  
 Corrugated links ..... 168  
 Corundum-coated paper ..... 103  
 Coverall ..... 153  
 Cup filter ..... 84  
 Current detector ..... 148  
 Cutter ..... 54ff  
 Cutter blades ..... 56ff

# D

**Name..... page**

Design flooring tools ..... 136ff  
 Diamond disc ..... 168  
 Disc holder ..... 164, 166  
 Disposable coarse-dust mask ..... 152  
 Disposable sieve ..... 84  
 Divider ..... 141  
 Door rack ..... 86ff  
 Door spreader ..... 16  
 Downpipe foil hose ..... 151  
 Drive-in electrode ..... 174  
 Drywall trowel ..... 113  
 DUOTEX trimmer ..... 96  
 Dust Masks ..... 153  
 Dust protection door ..... 151  
 Dust wiper(s) ..... 84

# E

**Name..... page**

EcoDist ..... 178  
 Edge planer ..... 114  
 Edge trimmer ..... 131  
 Edger ..... 65  
 Effect spatula ..... 30  
 Egalisette ..... 28  
 EIFS - blades ..... 102  
 EIFS - rasp ..... 103  
 Electric sealant gun cordless ..... 111  
 Electrode pins ..... 174ff  
 Embrasure spatula ..... 18  
 Epoxy grout float ..... 116  
 Epoxy tile grout scrubber ..... 117  
 Exchangeable trowel ..... 40ff

# F

**Name..... page**

Feeler gauge ..... 129  
 Finger protection holder ..... 70  
 Finishing spreader PAJAQUICK ..... 32ff  
 Finishing trowel ..... 24ff, 29ff  
 Finishing trowel PAJAQUICK ..... 31  
 First-aid box ..... 155

Flat chisel ..... 147  
 Float ..... 28  
 Float, plastic ..... 28  
 Floor covering knife ..... 53  
 Floor spreader ..... 123  
 Floor-to-ceiling pillar ..... 179  
 Floorlayer trowel ..... 29ff  
 Floorscraper, requires blade ..... 71, 129  
 Foam dispensing gun ..... 111  
 Funnel ..... 84  
 Furniture-dolly ..... 143

# G

**Name..... page**

Gel refill ..... 80  
 GeoDist ..... 178  
 Gilder cushion ..... 75  
 Gilder knife ..... 75  
 Glass cleaner ..... 70  
 Glass cutter ..... 118  
 Glass pane lifter ..... 119  
 Glass scraper ..... 70  
 Glazier square ..... 119  
 Gloves ..... 154ff  
 Glue syringe ..... 96, 142  
 Graining boy ..... 76  
 Graining combs ..... 76  
 Grinding discs ..... 87, 165, 167  
 Grinding stone ..... 167  
 Groove saw ..... 102  
 Grouting squeegee ..... 115

# H

**Name..... page**

Handle knob for cleaning u. Smoothness spatula..33  
 h-shaped profiles ..... 156  
 Hacking knife ..... 96  
 Hammers ..... 146  
 Hand brush ..... 150  
 Hand grooving tool ..... 133ff  
 Hand sander..... 64ff, 124  
 Hand shovel ..... 151  
 Hand trucks ..... 143  
 Hand welder ..... 168  
 Hard hat ..... 152  
 Hard metal blades ..... 68  
 Head protection hood ..... 153  
 Head seam straight-edge ..... 128  
 Hearing protection muffs ..... 152  
 Hinge set - Quick holders..... 33  
 Hole punch ..... 140  
 Hooked blades ..... 51ff  
 Hydromette ..... 172, 174ff

# I

**Name..... page**

Industrial heavy duty blade ..... 53  
 Insulating panel support..... 106  
 Insulation material knife ..... 102

# J

**Name..... page**

Japanese saw ..... 61  
 Japanese spatula ..... 13ff  
 Joiner's adjustable bevel ..... 140  
 Joiner's try squares ..... 140

# K

**Name..... page**

Knee pads ..... 126  
 Knotted wire wheel brush ..... 87

# L

**Name..... page**

Ladder hooks ..... 85  
 Laser technology ..... 176ff  
 Laser meters ..... 178  
 Laser thermometer ..... 170  
 Laserpoint-glasses ..... 179  
 LED Accumulator ..... 157  
 Left handed scissors ..... 58  
 Leica Geosystems ..... 178  
 Leveling spreader ..... 123  
 Line laser ..... 176ff  
 Linoleum cutter ..... 53  
 Linoleum flooring roller ..... 138ff  
 Linoleum scissors ..... 59  
 Loam trowels ..... 34ff  
 Lump hammer ..... 146

# M

**Name..... page**

Machinist's hammer ..... 146  
 Marble-effect spatula ..... 30  
 Marking stencil ..... 76ff  
 Measuring jug ..... 84  
 Metal snips ..... 60  
 Mineral wool knife ..... 102  
 Mini plastic trowel ..... 27  
 Mitre box ..... 63  
 Mitre cutter ..... 96  
 Mitre cutting shears ..... 60  
 Mixer ..... 108ff  
 Moisture meters ..... 171ff  
 Mould detector ..... 169  
 Moulding pins ..... 85  
 Moulding saw ..... 61  
 Moulding lifter (gooseneck) ..... 140  
 Multifunction scraper ..... 10

# N

**Name..... page**

Nails ..... 142

Natural sponge ..... 78  
 Notched blades ..... 44ff  
 Notched spreader ..... 39  
 Notching nippers ..... 38

# O

**Name..... page**

Offset stripping knife ..... 9  
 Overshoes ..... 153

# P

**Name..... page**

Pads ..... 166  
 Paint and Go ..... 81  
 Paint bucket ..... 81  
 Paint kettle cleaner ..... 74  
 Paint knife ..... 74  
 Paint removal scraper ..... 10  
 Paint roller cleaner ..... 82  
 Paint scraper ..... 68ff  
 Paint tray ..... 79  
 Painter's canvas tautening pliers ..... 75  
 Painter's straight edge ..... 75  
 Paintstick ..... 75  
 Paper Tiger perforating tool ..... 92  
 Parquet flooring pull scraper ..... 71  
 Parquet pull bars ..... 140  
 Pencils ..... 140  
 Perforators ..... 90ff  
 Pincers ..... 147  
 Pins ..... 142  
 Pins for panelling-beading ..... 85  
 Planing knife ..... 135  
 Plaster board cutter ..... 112  
 Plaster bowl ..... 83  
 Plaster cup ..... 83  
 Plaster pan ..... 113  
 Plasterer bucket trowel ..... 22  
 Plasterer plane grid ..... 37  
 Plasterer putty knife ..... 11  
 Plasterer trowel ..... 20,22  
 Plasterer's hatchet ..... 147  
 Plastic finishing trowel ..... 21, 25ff  
 Plastic folding rule ..... 156  
 Plastic spatulas ..... 14ff  
 Pliers ..... 147ff  
 Plum bob ..... 78  
 Pneumatic sealant gun ..... 111  
 Pointed blade ..... 133  
 Pointing trowel ..... 24  
 Pole sander ..... 65  
 Polishing brush ..... 89  
 Polystyrene cutter ..... 104ff  
 Polystyrene rasp ..... 103  
 Portable sprayer ..... 86  
 Pour and Go ..... 80  
 Power-Perfo ..... 90, 162  
 Pressure roller ..... 138ff  
 Profile gauge ..... 129

Profile ladder hooks ..... 85  
 Profile mitre box ..... 63  
 Protective goggles ..... 152  
 Pulling scraper ..... 70ff  
 Punch-lock riveter ..... 114  
 Push scraper ..... 71, 129  
 Putty knives ..... 118ff

# Q

**Name..... page**

Quarter moon, (spatula) knife ..... 135  
 Quick Cut 1881 & 1882 ..... 104  
 Quick Cut Multi 1890 ..... 105

# R

**Name..... page**

Rabo-Speed ..... 36  
 Rapid spreader ..... 16  
 Razor trimmer ..... 97  
 Refuse sacks ..... 151  
 Removal blanket ..... 151  
 Rex-Schneider ..... 96  
 Ring mixer ..... 108  
 Roll and Go ..... 80  
 Roller tube ..... 81  
 Roofing felt shearing knife ..... 149  
 Root brush ..... 150  
 Rotating laser ..... 176  
 Roughcast applicator ..... 37  
 Rubber mallet ..... 146  
 Rubber sanding block ..... 64  
 Rubber spatula ..... 15, 116  
 Rust removal chisel ..... 71  
 Rust removal hammer ..... 146  
 Rust removal scraper ..... 9ff  
 Rustication trowel ..... 23

# S

**Name..... page**

Safety knife ..... 50  
 Sanding block ..... 64  
 Sanding screens ..... 65  
 Sanding sponge ..... 65  
 Sash (compass) saw ..... 112  
 Saw blades ..... 61ff  
 Saw for rigid expanded PU ..... 62  
 Saws ..... 61ff  
 Scaffold ..... 158ff  
 Scissors ..... 59  
 Scissors ..... 58ff  
 Scissors holster ..... 59  
 Scorer ..... 168  
 Scrapers ..... 66ff  
 Scraper handle ..... 66ff  
 Screed hand sander ..... 124  
 Screed spreader ..... 122ff  
 Screed trowels ..... 29  
 Spotlights-LED ..... 157

## Alphabetical index

|                                    |                     |
|------------------------------------|---------------------|
| Scriber pins .....                 | 133                 |
| Scribing tool .....                | 132ff, 149          |
| Sealant guns .....                 | 110ff               |
| Sealant smoother .....             | 111                 |
| Sealant smoothing set .....        | 111                 |
| Seam clamps .....                  | 130                 |
| Seam cutter .....                  | 131                 |
| Seam roller .....                  | 100ff, 138          |
| Sheet metal nibbler .....          | 114                 |
| Sieves .....                       | 84                  |
| Single disc grinding-machine ..... | 164                 |
| Smoothing roller .....             | 99ff, 134, 136, 149 |
| Snap-off blades .....              | 51, 56ff            |
| Snap-off Knives .....              | 54ff                |
| Socket .....                       | 13                  |
| Spare blades .....                 | 66ff                |
| Special flooring hammer .....      | 138                 |
| Special snips .....                | 60                  |
| Spiked rollers .....               | 125                 |
| Spiked soles .....                 | 126ff               |
| Spirit level .....                 | 156                 |
| Sponge .....                       | 78                  |
| Spreader .....                     | 39, 42              |
| Spreader .....                     | 11ff                |
| Spreader trowel .....              | 38, 42              |
| Spreader, Swedish style .....      | 122                 |
| Spring clamp .....                 | 85                  |
| Square .....                       | 127                 |
| Square awl .....                   | 141                 |
| Square taping knife .....          | 10                  |
| Staining brush .....               | 89                  |
| Steel pads .....                   | 65                  |
| Steel square .....                 | 128                 |
| Steel straight edge .....          | 96                  |
| Steel wire broom .....             | 150                 |
| Steel wire brush .....             | 88                  |
| Steel wire hand brush .....        | 88                  |
| Steel wire scrub brush .....       | 150                 |
| Steel wire tube brush, .....       | 88                  |
| Steel wool .....                   | 65                  |
| Stencil knife .....                | 76                  |
| Stick-in electrodes pair M 6 ..... | 174ff               |
| Store and Go Basic .....           | 80                  |
| Store and Go XL .....              | 80                  |
| Straight blades .....              | 51ff                |
| Straight edge .....                | 97                  |
| Straight-edge .....                | 127ff               |
| Straight-edge, stainless .....     | 127ff               |
| Strip cutter .....                 | 132                 |
| Strip washer .....                 | 119                 |
| Strip-cutting King .....           | 136                 |
| Stripper .....                     | 163                 |
| Stripper roll .....                | 115                 |
| Stripping scraper .....            | 20                  |
| Stripping scraper .....            | 8ff                 |
| Stucco saw .....                   | 112                 |
| Stucco scratcher .....             | 37                  |

## T

|                                |          |
|--------------------------------|----------|
| <b>Name..... page</b>          |          |
| Tank .....                     | 164      |
| Tape measure .....             | 156      |
| Taping knife .....             | 113      |
| Taping knife .....             | 21       |
| Taping knife with bit .....    | 113      |
| Taping knife, .....            | 113      |
| Tapomat .....                  | 86       |
| Telescopic poles .....         | 79       |
| TELETOWER .....                | 158ff    |
| Textile scoissors .....        | 59       |
| Thermo-hygrometer .....        | 173      |
| Thickness meters .....         | 170      |
| Threshold straight-edge .....  | 128      |
| Tile cutter .....              | 117      |
| Tile grout sponge .....        | 116      |
| Tile hammer .....              | 117      |
| Tile hole cutter .....         | 117      |
| Tile hole nippers .....        | 117      |
| Tile washing bucket .....      | 115      |
| Tile wedges .....              | 115      |
| Tin snippers .....             | 60       |
| Tool bag .....                 | 129, 135 |
| Tool bag .....                 | 129      |
| Tool boxes .....               | 93ff     |
| Tool cases .....               | 93ff     |
| Triangular blade .....         | 66ff     |
| Trim guide .....               | 97       |
| Trimming knife .....           | 135      |
| Tripod .....                   | 179      |
| Tripod for led spotlight ..... | 157      |
| Tyrolean rendering tool .....  | 37       |

## U

|                            |        |
|----------------------------|--------|
| <b>Name..... page</b>      |        |
| Universal cutter .....     | 112    |
| Universal mixer .....      | 163    |
| Utility blades .....       | 51     |
| Utility knife .....        | 50, 53 |
| Utility taping knife ..... | 11     |

## V

|                       |     |
|-----------------------|-----|
| <b>Name..... page</b> |     |
| Vacuum ring .....     | 164 |
| Vacuum set .....      | 164 |
| Viscose sponge .....  | 78  |

## W

|                                 |      |
|---------------------------------|------|
| <b>Name..... page</b>           |      |
| Wall and ceiling scraper .....  | 66   |
| Wallpaper edger Combiral .....  | 96   |
| Wallpaper scissors .....        | 58ff |
| Wallpaper scraper .....         | 97   |
| Wallpaper shark .....           | 91   |
| Wallpaper smoother .....        | 97ff |
| Wallpaper steam stripper .....  | 92   |
| Wallpaper trim guide .....      | 96   |
| Wallpapering table .....        | 86   |
| Weld seam groover .....         | 53   |
| Welding seam guide .....        | 135  |
| Welding-rod feed roller .....   | 134  |
| Wet-coat measuring gauge .....  | 170  |
| Window and floor scrapers ..... | 69   |
| Window squeegee .....           | 119  |
| Wire cup brush .....            | 87   |
| Wooden folding rule .....       | 156  |
| Wooden knob .....               | 13   |

**00-99****Item number..... page**

|                       |     |
|-----------------------|-----|
| 033.....              | 97  |
| 050.....              | 74  |
| 067 - 067L/C.....     | 15  |
| 074 + R.....          | 59  |
| 075R.....             | 59  |
| 077A + B.....         | 96  |
| 092K, KS, R, SPK..... | 27  |
| 092SP.....            | 26  |
| 092STG.....           | 25  |
| 01500 + R.....        | 58  |
| 01535.....            | 58  |
| 01536L.....           | 58  |
| 2.....                | 8   |
| 2AR.....              | 8   |
| 2PR.....              | 8   |
| 2Z.....               | 39  |
| 3.....                | 9   |
| 4.....                | 9   |
| 7.....                | 9   |
| 7L.....               | 10  |
| 9A - 9F.....          | 10  |
| 19A.....              | 53  |
| 21.....               | 118 |
| 22R.....              | 118 |
| 25.....               | 74  |
| 30.....               | 74  |
| 31.....               | 74  |
| 34R.....              | 118 |
| 35.....               | 75  |
| 37.....               | 118 |
| 39.....               | 75  |
| 49R.....              | 74  |
| 51.....               | 74  |
| 55.....               | 118 |
| 57.....               | 50  |
| 57D - 57U.....        | 51  |
| 58.....               | 71  |
| 59/0,8.....           | 71  |
| 60.....               | 10  |
| 64.....               | 16  |
| 64Z.....              | 39  |
| 65 + R.....           | 13  |
| 66 + R.....           | 13  |
| 67.....               | 14  |
| 71.....               | 76  |
| 74.....               | 59  |
| 80R.....              | 127 |
| 81.....               | 141 |
| 85A + B.....          | 64  |
| 86 + R.....           | 127 |
| 87.....               | 64  |
| 88.....               | 83  |
| 89A - C.....          | 15  |
| 89W/A - C.....        | 15  |
| 90 + BW.....          | 25  |
| 92R.....              | 24  |
| 96.....               | 97  |

**100****Item number..... page**

|               |    |
|---------------|----|
| 100R.....     | 22 |
| 102E + R..... | 23 |
| 104R.....     | 17 |
| 105 + R.....  | 24 |
| 106.....      | 24 |
| 114.....      | 75 |

|                      |     |
|----------------------|-----|
| 116A/N - 116D/N..... | 138 |
| 116E - G.....        | 139 |
| 122 + K.....         | 156 |
| 123 - 123K.....      | 78  |
| 126G + G/R.....      | 11  |
| 128.....             | 71  |
| 129 + E.....         | 70  |
| 131A + E.....        | 66  |
| 132E.....            | 66  |
| 133E.....            | 66  |
| 134.....             | 97  |
| 137E.....            | 66  |
| 138.....             | 71  |
| 142 + EK.....        | 76  |
| 149.....             | 89  |
| 154 + E.....         | 118 |
| 155.....             | 70  |
| 155E.....            | 53  |
| 156.....             | 150 |
| 157.....             | 150 |
| 159 - 159SE.....     | 60  |
| 160.....             | 88  |
| 163.....             | 88  |
| 164.....             | 88  |
| 166.....             | 89  |
| 167.....             | 89  |
| 168.....             | 89  |
| 169.....             | 88  |
| 170.....             | 70  |
| 171.....             | 70  |
| 172.....             | 70  |
| 174.....             | 60  |
| 175.....             | 78  |
| 181R.....            | 22  |
| 189 - 189BW.....     | 29  |
| 189R.....            | 29  |
| 189Z.....            | 38  |
| 190.....             | 116 |
| 193 - 193H.....      | 117 |
| 195B - 195F.....     | 28  |
| 195K.....            | 28  |
| 197M.....            | 115 |

**200****Item number..... page**

|                        |     |
|------------------------|-----|
| 200.....               | 9   |
| 208.....               | 117 |
| 209.....               | 75  |
| 212.....               | 128 |
| 213.....               | 128 |
| 214B/L - 214B/R/L..... | 127 |
| 220.....               | 75  |
| 221.....               | 119 |
| 226 - 226P.....        | 100 |
| 227.....               | 101 |
| 228.....               | 101 |
| 229.....               | 101 |
| 230 + K.....           | 77  |
| 231.....               | 77  |
| 234.....               | 142 |
| 240.....               | 76  |
| 245.....               | 85  |
| 250.....               | 146 |
| 251.....               | 146 |
| 253 + S.....           | 142 |
| 255.....               | 146 |
| 256.....               | 147 |
| 258 - 258E/B.....      | 63  |
| 259.....               | 112 |

|                 |    |
|-----------------|----|
| 260.....        | 61 |
| 262 + 262S..... | 63 |
| 277.....        | 80 |
| 279 + P.....    | 81 |
| 282.....        | 84 |
| 287.....        | 84 |

**300****Item number..... page**

|                   |     |
|-------------------|-----|
| 309AR + AR/2..... | 23  |
| 310AR + AR/2..... | 23  |
| 316 + E.....      | 117 |
| 325R.....         | 22  |
| 326.....          | 37  |
| 327.....          | 103 |
| 328 + E.....      | 116 |
| 332.....          | 156 |
| 334.....          | 97  |
| 345.....          | 108 |
| 346.....          | 108 |
| 348.....          | 108 |
| 349/1 - 4.....    | 53  |
| 349A.....         | 53  |
| 351S.....         | 108 |
| 360.....          | 59  |
| 370.....          | 65  |
| 371.....          | 65  |
| 377.....          | 28  |
| 378.....          | 28  |
| 384 + R.....      | 10  |
| 387.....          | 10  |
| 390 + R.....      | 39  |
| 398.....          | 116 |
| 399.....          | 116 |

**400****Item number..... page**

|                   |     |
|-------------------|-----|
| 400 - 400EC.....  | 129 |
| 401.....          | 132 |
| 401.1/2.....      | 132 |
| 401E.....         | 133 |
| 403.....          | 132 |
| 404.....          | 133 |
| 405.....          | 138 |
| 406 + K.....      | 92  |
| 407B + 407BK..... | 132 |
| 407BE.....        | 133 |
| 408.....          | 138 |
| 409.....          | 92  |
| 414 - 414E/M..... | 62  |
| 419.....          | 146 |
| 421.....          | 133 |
| 423.....          | 62  |
| 440.....          | 136 |
| 441.....          | 112 |
| 442.....          | 136 |
| 443 + E.....      | 137 |
| 446 + R.....      | 16  |
| 447R.....         | 16  |
| 456.....          | 84  |
| 458.....          | 84  |
| 459F + M.....     | 84  |

# 500

| Item number.....     | page    |
|----------------------|---------|
| 509 + P.....         | 85      |
| 517.....             | 85      |
| 522 + S.....         | 142     |
| 529.....             | 152     |
| 530.....             | 85      |
| 531.....             | 153     |
| 534.....             | 152     |
| 537.....             | 153     |
| 538 + G.....         | 152     |
| 539 + W.....         | 152     |
| 541A + E.....        | 154     |
| 541D + F.....        | 155     |
| 541H.....            | 154     |
| 541M - S.....        | 155     |
| 542.....             | 153     |
| 548.....             | 152     |
| 549.....             | 153     |
| 555.....             | 50      |
| 560 + E.....         | 119     |
| 561.....             | 119     |
| 570D/K - 570H/K..... | 52      |
| 570E/K.....          | 52, 136 |
| 570S.....            | 50      |
| 575E - H.....        | 52      |

# 600

| Item number.....  | page     |
|-------------------|----------|
| 602L.....         | 95       |
| 602M.....         | 93       |
| 606L.....         | 95       |
| 607L.....         | 95       |
| 610A - D.....     | 134      |
| 611.....          | 134      |
| 613 - K/G.....    | 36       |
| 614 + Z.....      | 37       |
| 615.....          | 37       |
| 624.....          | 109      |
| 625.....          | 109      |
| 626.....          | 109      |
| 629.....          | 109      |
| 633 + E.....      | 112      |
| 634R.....         | 113      |
| 635R.....         | 113      |
| 636.....          | 112      |
| 638R.....         | 113      |
| 642 + E.....      | 114      |
| 643 - 643EM.....  | 114      |
| 644 - EM.....     | 114      |
| 647.....          | 112      |
| 648A + E.....     | 11       |
| 649.....          | 114      |
| 652.....          | 70       |
| 653 - 653P.....   | 79       |
| 654 - 654SE.....  | 119      |
| 655 + R.....      | 11       |
| 656R.....         | 12       |
| 657.....          | 13       |
| 658 - 658E/4..... | 53       |
| 659 + F.....      | 135      |
| 660 + E.....      | 134      |
| 661 - 661V.....   | 135      |
| 662 - 662E.....   | 133      |
| 664.....          | 134      |
| 664E.....         | 133, 134 |
| 665B + E.....     | 131      |
| 665E + EG.....    | 53       |

|                   |     |
|-------------------|-----|
| 668 + 668A.....   | 130 |
| 669 + S.....      | 130 |
| 671.....          | 29  |
| 675A - 675C.....  | 123 |
| 676.....          | 123 |
| 677 - 677F/S..... | 123 |
| 677E.....         | 124 |
| 677Z + 677ZE..... | 124 |
| 678R.....         | 123 |
| 679.....          | 122 |
| 686.....          | 151 |
| 699 + F.....      | 115 |

# 700

| Item number.....  | page |
|-------------------|------|
| 702.....          | 81   |
| 703.....          | 83   |
| 720 + E.....      | 86   |
| 721.....          | 87   |
| 734.....          | 140  |
| 735.....          | 140  |
| 744 - 744L.....   | 69   |
| 745.....          | 69   |
| 748.....          | 101  |
| 749.....          | 100  |
| 751.....          | 101  |
| 752.....          | 138  |
| 753 + E.....      | 99   |
| 753W + WE.....    | 99   |
| 754.....          | 101  |
| 757.....          | 149  |
| 758.....          | 149  |
| 759.....          | 149  |
| 760.....          | 60   |
| 764.....          | 60   |
| 766R.....         | 128  |
| 767 + E.....      | 132  |
| 768 + E.....      | 131  |
| 769.....          | 97   |
| 774 - 774R/K..... | 128  |
| 776.....          | 129  |
| 777.....          | 42   |
| 777E.....         | 45   |
| 777E/56.....      | 123  |
| 779E.....         | 44   |
| 779E/56.....      | 123  |
| 779R.....         | 42   |
| 781/70.....       | 140  |
| 782A + B.....     | 140  |
| 792N.....         | 143  |
| 795.....          | 143  |
| 759.....          | 143  |
| 799.....          | 59   |

# 800

| Item number..... | page |
|------------------|------|
| 817H.....        | 117  |
| 819.....         | 146  |
| 820.....         | 115  |
| 821.....         | 117  |
| 822.....         | 115  |
| 824.....         | 102  |
| 828.....         | 115  |
| 830A + E.....    | 65   |
| 831 + E.....     | 103  |
| 832 + E.....     | 103  |
| 835.....         | 156  |
| 838.....         | 156  |
| 842B + E.....    | 113  |

|                 |     |
|-----------------|-----|
| 846A + E.....   | 71  |
| 846A + E.....   | 129 |
| 850A + E.....   | 71  |
| 850A + E.....   | 129 |
| 851 - 851K..... | 66  |
| 852 + E.....    | 66  |
| 853 - 853E..... | 69  |
| 854 + E.....    | 65  |
| 856 + E.....    | 65  |
| 857.....        | 28  |
| 858.....        | 85  |
| 859.....        | 85  |
| 860.....        | 29  |
| 860R.....       | 30  |
| 861.....        | 29  |
| 863R.....       | 30  |
| 864R.....       | 30  |
| 865R.....       | 113 |
| 866R.....       | 31  |
| 874.....        | 165 |
| 876.....        | 124 |
| 877.....        | 139 |
| 879.....        | 139 |
| 880.....        | 83  |
| 888.....        | 131 |

# 900

| Art.-Nr.....      | Seite |
|-------------------|-------|
| 900.....          | 35    |
| 901.....          | 35    |
| 902.....          | 35    |
| 903.....          | 34    |
| 906.....          | 92    |
| 908 + E.....      | 92    |
| 909 CE.....       | 126   |
| 910 CE.....       | 126   |
| 920.....          | 140   |
| 921.....          | 141   |
| 922.....          | 141   |
| 936.....          | 130   |
| 937.....          | 130   |
| 938.....          | 140   |
| 940 - 940 ES..... | 38    |
| 942L.....         | 129   |
| 954.....          | 96    |
| 955.....          | 98    |
| 956.....          | 98    |
| 957.....          | 98    |
| 958.....          | 98    |
| 959R.....         | 96    |
| 960.....          | 96    |
| 962P.....         | 110   |
| 964 - 964P.....   | 110   |
| 965.....          | 96    |
| 965.....          | 142   |
| 966.....          | 96    |
| 968.....          | 110   |
| 969.....          | 111   |
| 970.....          | 111   |
| 971.....          | 110   |
| 977R.....         | 96    |
| 998.....          | 41    |
| 999R.....         | 42    |

# 1000

| Item number..... | page    |
|------------------|---------|
| 1000 + E.....    | 90, 162 |
| 1001.....        | 90, 162 |
| 1100 + E.....    | 91      |

|                    |          |
|--------------------|----------|
| 1590 - 1590M ..... | 60       |
| 1800.....          | 106      |
| 1881 + E .....     | 104      |
| 1882 + E .....     | 105      |
| 1884 + E .....     | 104, 105 |
| 1885.....          | 104, 105 |
| 1890.....          | 105      |

## 2000

|                              |    |
|------------------------------|----|
| <b>Item number..... page</b> |    |
| 2000N + NE .....             | 37 |
| 2075 + R .....               | 59 |
| 2600E .....                  | 68 |
| 2601E .....                  | 68 |
| 2602E .....                  | 68 |

## 3000

|                              |    |
|------------------------------|----|
| <b>Item number..... page</b> |    |
| 3002.....                    | 20 |
| 3092STG .....                | 21 |
| 3093R .....                  | 21 |
| 3100R .....                  | 20 |
| 3104R .....                  | 20 |
| 3325R .....                  | 20 |
| 3634R/B .....                | 21 |
| 3655R .....                  | 21 |

## 4000

|                              |     |
|------------------------------|-----|
| <b>Item number..... page</b> |     |
| 4433.....                    | 89  |
| 4444.....                    | 82  |
| 4455.....                    | 81  |
| 4680K + L.....               | 122 |
| 4801 + 4802 .....            | 79  |
| 4810A + B.....               | 79  |
| 4900.....                    | 125 |
| 4901.....                    | 125 |
| 4902.....                    | 125 |
| 4910 - 4910R.....            | 127 |
| 4911.....                    | 126 |

## 5000

|                              |     |
|------------------------------|-----|
| <b>Item number..... page</b> |     |
| 5001.....                    | 86  |
| 5002.....                    | 8   |
| 5092RS.....                  | 24  |
| 5092STG .....                | 25  |
| 5093R .....                  | 25  |
| 5093RZ.....                  | 38  |
| 5100R .....                  | 22  |
| 5104R .....                  | 17  |
| 5325R .....                  | 22  |
| 5555/R.....                  | 170 |
| 5600 - 5600ET.....           | 68  |
| 5601 + E .....               | 68  |
| 5602 + E .....               | 68  |
| 5634R .....                  | 113 |
| 5655K .....                  | 13  |
| 5655R .....                  | 12  |
| 5656.....                    | 18  |
| 5660RA + RRA .....           | 12  |
| 5700SP.....                  | 130 |
| 5701.....                    | 149 |
| 5709.....                    | 56  |
| 5710E + EK.....              | 57  |
| 5711E + EK.....              | 56  |
| 5711EK/O.K.....              | 69  |
| 5713.....                    | 55  |
| 5715.....                    | 54  |

|                   |     |
|-------------------|-----|
| 5716E + E/W ..... | 102 |
| 5717.....         | 54  |
| 5717E .....       | 57  |
| 5718.....         | 56  |
| 5718E.....        | 57  |
| 5719.....         | 54  |
| 5720.....         | 54  |
| 5721.....         | 54  |
| 5724.....         | 56  |
| 5725.....         | 54  |
| 5728.....         | 56  |
| 5866R.....        | 31  |
| 5999R.....        | 42  |

## 6000

|                              |          |
|------------------------------|----------|
| <b>Item number..... page</b> |          |
| 6008.....                    | 158      |
| 6015BL .....                 | 172      |
| 6016BL .....                 | 172      |
| 6017 - 6017.6 .....          | 175      |
| 6017.4 - 6017.6 .....        | 174      |
| 6018.....                    | 174      |
| 6019.....                    | 174      |
| 6020.....                    | 174, 175 |
| 6021.....                    | 174      |
| 6022.....                    | 174, 175 |
| 6023.....                    | 174, 175 |
| 6024.....                    | 174, 175 |
| 6025.....                    | 174, 175 |
| 6026.....                    | 174, 175 |
| 6030.....                    | 178      |
| 6031.....                    | 178      |
| 6034HP.....                  | 177      |
| 6035.....                    | 176      |
| 6036.....                    | 179      |
| 6037HP.....                  | 177      |
| 6038HP.....                  | 177      |
| 6039HP.....                  | 176      |
| 6040.....                    | 179      |
| 6041.....                    | 179      |
| 6043.....                    | 179      |
| 6044HP.....                  | 176      |
| 6052.....                    | 86       |
| 6053.....                    | 86       |
| 6071.....                    | 170      |
| 6072.....                    | 169      |
| 6073.....                    | 170      |
| 6074.....                    | 172      |
| 6075.....                    | 171      |
| 6150N.....                   | 170      |
| 6151.....                    | 170      |

## 7000

|                              |        |
|------------------------------|--------|
| <b>Item number..... page</b> |        |
| 7060E .....                  | 157    |
| 7653.....                    | 79     |
| 7656R + RE .....             | 33     |
| 7658.....                    | 33, 36 |
| 7659.....                    | 33     |
| 7660.....                    | 33     |
| 7661.....                    | 33     |

## 8000

|                              |     |
|------------------------------|-----|
| <b>Item number..... page</b> |     |
| 8002.....                    | 8   |
| 8007.....                    | 9   |
| 8007L.....                   | 10  |
| 8020.....                    | 119 |
| 8033.....                    | 98  |

|                          |     |
|--------------------------|-----|
| 8034.....                | 15  |
| 8035.....                | 15  |
| 8057E + H.....           | 52  |
| 8065 + R.....            | 14  |
| 8066.....                | 14  |
| 8067.....                | 14  |
| 8068.....                | 149 |
| 8072A + B.....           | 76  |
| 8087A + B.....           | 64  |
| 8088.....                | 83  |
| 8091H - 8091 W .....     | 26  |
| 8092K, KS, RK, SPK ..... | 27  |
| 8092R .....              | 25  |
| 8092RZ.....              | 38  |
| 8092SP.....              | 26  |
| 8092ST + STG.....        | 25  |
| 8095.....                | 26  |
| 8100R .....              | 22  |
| 8104R .....              | 17  |
| 8112.....                | 151 |
| 8115.....                | 111 |
| 8124.....                | 78  |
| 8131A + E.....           | 67  |
| 8132E .....              | 67  |
| 8133E .....              | 67  |
| 8153.....                | 58  |
| 8165 + R.....            | 13  |
| 8166.....                | 13  |
| 8175.....                | 78  |
| 8189.....                | 29  |
| 8189R.....               | 29  |
| 8190.....                | 116 |
| 8191MF + MG .....        | 65  |
| 8200.....                | 9   |
| 8223.....                | 156 |
| 8226.....                | 100 |
| 8226M .....              | 101 |
| 8255.....                | 147 |
| 8266.....                | 62  |
| 8291.....                | 84  |
| 8302 - LS.....           | 29  |
| 8309R .....              | 23  |
| 8310R .....              | 23  |
| 8325R .....              | 22  |
| 8391.....                | 39  |
| 8392.....                | 39  |
| 8397.....                | 116 |
| 8399.....                | 116 |
| 8409.....                | 92  |
| 8414 + E .....           | 62  |
| 8415 + E .....           | 62  |
| 8423.....                | 62  |
| 8444.....                | 82  |
| 8446 + R.....            | 16  |
| 8464.....                | 84  |
| 8480.....                | 79  |
| 8490.....                | 125 |
| 8491 .....               | 125 |
| 8492.....                | 125 |

|                 |     |
|-----------------|-----|
| 8535.....       | 152 |
| 8541C.....      | 154 |
| 8541M.....      | 155 |
| 8541PU + U..... | 154 |
| 8555R.....      | 12  |
| 8575.....       | 50  |
| 8600.....       | 68  |
| 8601.....       | 68  |
| 8602.....       | 68  |
| 8626.....       | 109 |
| 8632.....       | 39  |
| 8652 + E.....   | 70  |
| 8653.....       | 79  |
| 8654.....       | 70  |
| 8655R.....      | 11  |
| 8655RZ.....     | 97  |
| 8655Z.....      | 122 |
| 8656R.....      | 12  |
| 8710.....       | 56  |
| 8710E.....      | 57  |
| 8711.....       | 55  |
| 8711E.....      | 57  |
| 8712.....       | 55  |
| 8717.....       | 55  |
| 8719.....       | 55  |
| 8749.....       | 100 |
| 8753 + W.....   | 99  |
| 8773.....       | 97  |
| 8779.....       | 42  |
| 8821.....       | 147 |
| 8823.....       | 147 |
| 8853.....       | 69  |
| 8854.....       | 65  |
| 8862R.....      | 30  |
| 8880.....       | 83  |
| 8913.....       | 140 |
| 8976.....       | 58  |

## 9000

|                              |    |
|------------------------------|----|
| <b>Item number..... page</b> |    |
| 9070.....                    | 92 |
| 9292R.....                   | 24 |
| 9997 + E.....                | 61 |
| 9998.....                    | 61 |
| 9999 + A.....                | 61 |

## 10000

|                              |     |
|------------------------------|-----|
| <b>Item number..... page</b> |     |
| 10266.....                   | 148 |
| 10267.....                   | 148 |
| 10393.....                   | 102 |
| 10395.....                   | 102 |
| 11600.....                   | 139 |

## 50000

|                              |     |
|------------------------------|-----|
| <b>Item number..... page</b> |     |
| 50280.....                   | 163 |
| 50307.....                   | 61  |
| 50309.....                   | 63  |
| 50851.....                   | 143 |
| 51006.....                   | 150 |
| 51007.....                   | 150 |
| 51008.....                   | 151 |
| 51009.....                   | 150 |
| 51010.....                   | 150 |
| 51011.....                   | 150 |
| 51012.....                   | 150 |
| 51013.....                   | 78  |
| 51014.....                   | 78  |

|                      |     |
|----------------------|-----|
| 51015.....           | 150 |
| 51016.....           | 150 |
| 51017.....           | 149 |
| 51020.....           | 87  |
| 51021.....           | 87  |
| 51022.....           | 150 |
| 51030.....           | 87  |
| 51031.....           | 87  |
| 51032.....           | 87  |
| 51033.....           | 150 |
| 55309.....           | 148 |
| 55518.....           | 148 |
| 55522.....           | 148 |
| 55618.....           | 147 |
| 55619.....           | 147 |
| 55621.....           | 147 |
| 55668.....           | 148 |
| 57170.....           | 55  |
| 58740.....           | 124 |
| 58838.....           | 102 |
| 58839 + L.....       | 102 |
| 58841 - 58841EL..... | 102 |

## 60000

|                              |     |
|------------------------------|-----|
| <b>Item number..... page</b> |     |
| 60909.....                   | 126 |
| 60910.....                   | 126 |
| 61011 + E.....               | 163 |
| 61012.....                   | 163 |
| 61138.....                   | 166 |
| 61139.....                   | 166 |
| 61140.....                   | 166 |
| 61141.....                   | 166 |
| 61142.....                   | 166 |
| 61143.....                   | 166 |
| 61149.....                   | 165 |
| 61150.....                   | 165 |
| 61151.....                   | 165 |
| 61152.....                   | 165 |
| 61153.....                   | 165 |
| 61154.....                   | 165 |
| 61156.....                   | 165 |
| 61157.....                   | 165 |
| 61158.....                   | 165 |
| 61159.....                   | 165 |
| 61160.....                   | 165 |
| 61161.....                   | 165 |
| 61163.....                   | 166 |
| 61164.....                   | 166 |
| 61165.....                   | 166 |
| 61166.....                   | 166 |
| 61167.....                   | 166 |
| 61170 + E.....               | 167 |
| 61171 + E.....               | 167 |
| 61172.....                   | 165 |
| 61173.....                   | 165 |
| 61174.....                   | 165 |
| 61175.....                   | 165 |
| 61176.....                   | 165 |
| 61177.....                   | 165 |
| 61300 + E.....               | 171 |
| 61320.....                   | 173 |
| 61330.....                   | 173 |
| 61340.....                   | 173 |
| 61350.....                   | 171 |
| 61435 + E.....               | 131 |
| 61440.....                   | 131 |
| 61520.....                   | 168 |
| 61521 + E.....               | 164 |

|                |     |
|----------------|-----|
| 61522 + E..... | 164 |
| 61525.....     | 166 |
| 61526.....     | 166 |
| 61530.....     | 168 |
| 61633.....     | 167 |
| 61639.....     | 167 |
| 62700.....     | 168 |
| 62800.....     | 164 |
| 62801.....     | 164 |
| 62802.....     | 164 |
| 62803.....     | 164 |
| 62804.....     | 164 |
| 62900.....     | 135 |
| 62901.....     | 135 |
| 62902.....     | 135 |
| 62903.....     | 135 |
| 66071.....     | 76  |

## 70000

|                              |     |
|------------------------------|-----|
| <b>Item number..... page</b> |     |
| 71138.....                   | 111 |
| 71146.....                   | 86  |
| 71296 + L.....               | 94  |
| 71371.....                   | 151 |
| 71374.....                   | 155 |
| 71557.....                   | 111 |
| 71558.....                   | 111 |
| 71561.....                   | 111 |
| 71606.....                   | 94  |
| 71962P.....                  | 110 |
| 72371 + 72371k.....          | 151 |
| 75276 - 75276V.....          | 81  |
| 75277 - 75277P.....          | 81  |
| 75278.....                   | 80  |
| 75279.....                   | 80  |
| 75280.....                   | 80  |
| 75281.....                   | 80  |
| 77043N.....                  | 157 |
| 77044N.....                  | 157 |
| 77045N.....                  | 157 |
| 77046N.....                  | 157 |
| 77047N.....                  | 157 |
| 77048N.....                  | 157 |

## 80000

|                              |    |
|------------------------------|----|
| <b>Item number..... page</b> |    |
| 87170.....                   | 54 |

## Steinel

|                            |     |
|----------------------------|-----|
| <b>Art.-Nr. .... Seite</b> |     |
| 075316.....                | 168 |
| 092016.....                | 168 |
| 092115.....                | 168 |
| 092214.....                | 168 |
| 351809.....                | 168 |



## Your Floor. Our Passion.

The Uzin Utz Group represents the complete range of flooring competence.

With the brands UZIN, WOLFF, PALLMANN, Arturo, codex and Pajarito, we offer an extensive range of products, systems and services for the installation, renovation, and maintenance of all types of floor coverings, wood flooring, coatings, ceramic tiles and natural stone floors.

For all questions concerning flooring we are a competent and reliable partner.

---



### **UZIN. THE FLOOR BELONGS TO YOU.**

Installation systems for screeds, flooring and wood flooring.



### **WOLFF going beyond your limits**

Machinery and special tools for subfloor preparation and installation of floor coverings.



### **PALLMANN My wood floor. My life.**

Complete product range for the installation, renovation and maintenance of wood flooring.



### **Arturo what a floor can do.**

Functional floor coatings with manifold design options.



### **codex exclusive to real tilers.**

Installation systems for tiles and natural stone.



### **Pajarito From professionals for professionals**

Tools for floor, wall and ceiling.

---



**PAJARITO**  
WERKZEUGE

Korbach Werkzeug Co. GmbH & Co. KG  
Pajarito-Werkzeugfabrik  
Schöllersheider Straße 1 · 40822 Mettmann  
Tel.: +49 (0) 2104 / 30 00-0 · Fax: +49 (0) 2104 / 16 249  
info@pajarito.de · www.pajarito.de